

LOC	DIST	REVISIONS				
P	LTR	DESCRIPTION	DATE	DWN	APVD	
E	B	BA	NEW RELEASE	08-JAN-09	SM	St.P

FOR FURTHER INFORMATION SEE DATA SHEET FOR
CRG SERIES-THICK FILM CHIP RESISTORS

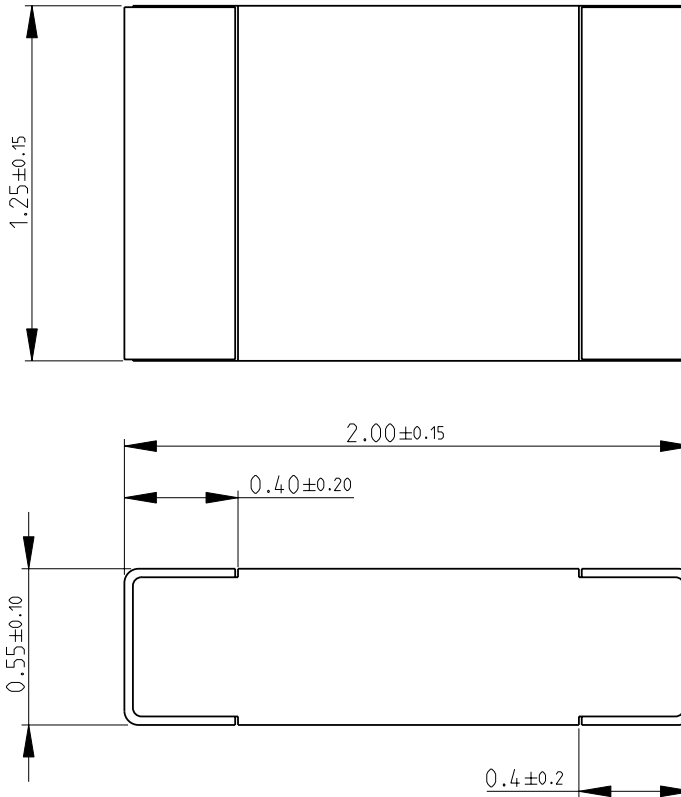

RoHS Compliant

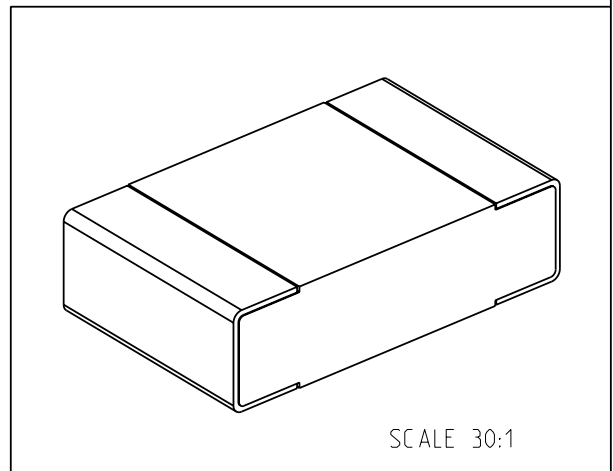

2009

RELEASED FOR PUBLICATION

THIS DRAWING IS UNPUBLISHED.

© COPYRIGHT 2009 BY TYCO ELECTRONICS CORPORATION. ALL RIGHTS RESERVED.

DIMENSIONS: mm	DWN	SUBHASH.M	08-JAN-09	MATERIAL	-	FINISH	-
	CHK	PRAKASH.S	08-JAN-09	Tyco Electronics Corporation Dorcan, Swindon, SN3 5HH			
TOLERANCES UNLESS OTHERWISE SPECIFIED:	APVD	STEPHEN.P	08-JAN-09				
	PRODUCT SPEC	-	-	SIZE	CAGE CODE	DRAWING NO	RESTRICTED TO
	APPLICATION SPEC	-	-	A 4	00779	© = 1623169	-
0 PLC ±0.5 1 PLC ±0.2 2 PLC ±0.1 3 PLC ±- 4 PLC ±- ANGLES ±5°	WEIGHT	-	-	CUSTOMER DRAWING		SCALE	40:1
					SHEET	1	OF 1
						REV	BA