

SKM 200GB126D ...

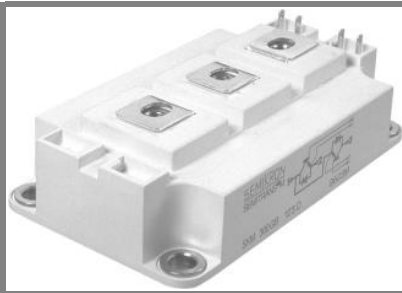

SEMITRANS® 3

Trench IGBT Modules

SKM 200GB126D

SKM 200GAL126D

Features

- Trench = Trenchgate technology
- $V_{CE(sat)}$ with positive temperature coefficient
- High short circuit capability, self limiting to $6 \times I_C$

Typical Applications*

- Electronic welders
- AC inverter drives
- UPS

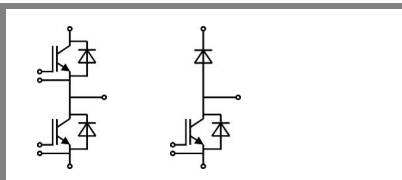

GB

GAL

Absolute Maximum Ratings		$T_{case} = 25^\circ\text{C}$, unless otherwise specified		
Symbol	Conditions	Values		Units
IGBT				
V_{CES}	$T_j = 25^\circ\text{C}$	1200		V
I_C	$T_j = 150^\circ\text{C}$	$T_c = 25^\circ\text{C}$	260	A
		$T_c = 80^\circ\text{C}$	190	A
I_{CRM}	$I_{CRM} = 2 \times I_{Cnom}$	300		A
V_{GES}		± 20		V
t_{psc}	$V_{CC} = 600\text{ V}; V_{GE} \leq 20\text{ V}; T_j = 125^\circ\text{C}$ $V_{CES} < 1200\text{ V}$	10		μs
Inverse Diode				
I_F	$T_j = 150^\circ\text{C}$	$T_c = 25^\circ\text{C}$	200	A
		$T_c = 80^\circ\text{C}$	140	A
I_{FRM}	$I_{FRM} = 2 \times I_{Fnom}$	300		A
I_{FSM}	$t_p = 10\text{ ms}; \text{sin.}$	$T_j = 150^\circ\text{C}$	1100	A
Freewheeling Diode				
I_F	$T_j = 150^\circ\text{C}$	$T_c = 25^\circ\text{C}$	200	A
		$T_c = 80^\circ\text{C}$	140	A
I_{FRM}	$I_{FRM} = 2 \times I_{Fnom}$	300		A
I_{FSM}	$t_p = 10\text{ ms}; \text{sin.}$	$T_j = 150^\circ\text{C}$	1100	A
Module				
$I_{t(RMS)}$		500		A
T_{vj}		- 40 ... + 150		$^\circ\text{C}$
T_{stg}		- 40 ... + 125		$^\circ\text{C}$
V_{isol}	AC, 1 min.	4000		V

Characteristics		$T_{case} = 25^\circ\text{C}$, unless otherwise specified			
Symbol	Conditions	min.	typ.	max.	Units
IGBT					
$V_{GE(th)}$	$V_{GE} = V_{CE}, I_C = 6\text{ mA}$	5	5,8	6,5	V
I_{CES}	$V_{GE} = 0\text{ V}, V_{CE} = V_{CES}$	$T_j = 25^\circ\text{C}$	0,1	0,3	mA
		$T_j = 125^\circ\text{C}$			mA
V_{CE0}		$T_j = 25^\circ\text{C}$	1	1,2	V
		$T_j = 125^\circ\text{C}$	0,9	1,1	V
r_{CE}	$V_{GE} = 15\text{ V}$	$T_j = 25^\circ\text{C}$	4,7	6,3	$\text{m}\Omega$
		$T_j = 125^\circ\text{C}$	7,3	9	$\text{m}\Omega$
$V_{CE(sat)}$	$I_{Cnom} = 150\text{ A}, V_{GE} = 15\text{ V}$	$T_j = 25^\circ\text{C}_{chiplev.}$	1,7	2,15	V
		$T_j = 125^\circ\text{C}_{chiplev.}$	2	2,45	V
C_{ies}	$V_{CE} = 25, V_{GE} = 0\text{ V}$	$f = 1\text{ MHz}$	10,8		nF
C_{oes}			0,9		nF
C_{res}			0,9		nF
Q_G	$V_{GE} = -8\text{ V} - +20\text{ V}$	1530		nC	
R_{Gint}	$T_j = 25^\circ\text{C}$	5		Ω	
$t_{d(on)}$	$R_{Gon} = 1,5\ \Omega$	$V_{CC} = 600\text{ V}$ $I_C = 150\text{ A}$	260		ns
t_r			40		ns
E_{on}	$R_{Goff} = 1,5\ \Omega$	$T_j = 125^\circ\text{C}$ $V_{GE} = \pm 15\text{ V}$	18		mJ
$t_{d(off)}$			540		ns
t_f			110		ns
E_{off}			mJ		
$R_{th(j-c)}$	per IGBT	0,13		K/W	

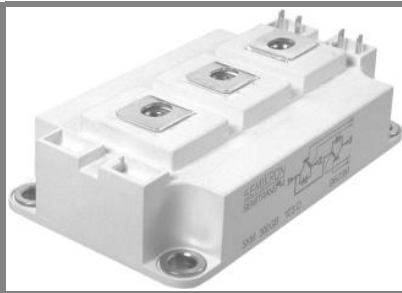

SEMITRANS® 3

Trench IGBT Modules

SKM 200GB126D

SKM 200GAL126D

Features

- Trench = Trenchgate technology
- $V_{CE(sat)}$ with positive temperature coefficient
- High short circuit capability, self limiting to $6 \times I_C$

Typical Applications*

- Electronic welders
- AC inverter drives
- UPS

Characteristics					
Symbol	Conditions	min.	typ.	max.	Units
Inverse diode					
$V_F = V_{EC}$	$I_{Fnom} = 150 \text{ A}; V_{GE} = 0 \text{ V}$	$T_j = 25 \text{ }^\circ\text{C}_{chiplev.}$	1,6	1,8	V
		$T_j = 125 \text{ }^\circ\text{C}_{chiplev.}$	1,6	1,8	V
V_{F0}		$T_j = 25 \text{ }^\circ\text{C}$	1	1,1	V
		$T_j = 125 \text{ }^\circ\text{C}$	0,8	0,9	V
r_F		$T_j = 25 \text{ }^\circ\text{C}$	4	4,7	m Ω
		$T_j = 125 \text{ }^\circ\text{C}$	5,3	6	m Ω
I_{RRM}	$I_F = 150 \text{ A}$	$T_j = 125 \text{ }^\circ\text{C}$	240		A
Q_{rr}	$di/dt = 5000 \text{ A}/\mu\text{s}$		42		μC
E_{tr}	$V_{GE} = -15 \text{ V}; V_{CC} = 600 \text{ V}$				mJ
$R_{th(j-c)D}$	per diode			0,3	K/W
FWD					
$V_F = V_{EC}$	$I_{Fnom} = 150 \text{ A}; V_{GE} = 0 \text{ V}$	$T_j = 25 \text{ }^\circ\text{C}_{chiplev.}$	1,6	1,8	V
		$T_j = 125 \text{ }^\circ\text{C}_{chiplev.}$	1,6	1,8	V
V_{F0}		$T_j = 25 \text{ }^\circ\text{C}$	1	1,1	V
		$T_j = 125 \text{ }^\circ\text{C}$	0,8	0,9	V
r_F		$T_j = 25 \text{ }^\circ\text{C}$	4	4,7	V
		$T_j = 125 \text{ }^\circ\text{C}$	5,3	6	V
I_{RRM}	$I_F = 150 \text{ A}$	$T_j = 125 \text{ }^\circ\text{C}$	240		A
Q_{rr}	$di/dt = 5000 \text{ A}/\mu\text{s}$		42		μC
E_{tr}	$V_{GE} = -15 \text{ V}; V_{CC} = 600 \text{ V}$				mJ
$R_{th(j-c)FD}$	per diode			0,3	K/W
Module					
L_{CE}			15	20	nH
$R_{CC'+EE'}$	res., terminal-chip	$T_{case} = 25 \text{ }^\circ\text{C}$	0,35		m Ω
		$T_{case} = 125 \text{ }^\circ\text{C}$	0,5		m Ω
$R_{th(c-s)}$	per module			0,038	K/W
M_s	to heat sink M6		3	5	Nm
M_t	to terminals M5		2,5	5	Nm
w				325	g

This is an electrostatic discharge sensitive device (ESDS), international standard IEC 60747-1, Chapter IX.

* The specifications of our components may not be considered as an assurance of component characteristics. Components have to be tested for the respective application. Adjustments may be necessary. The use of SEMIKRON products in life support appliances and systems is subject to prior specification and written approval by SEMIKRON. We therefore strongly recommend prior consultation of our personal.

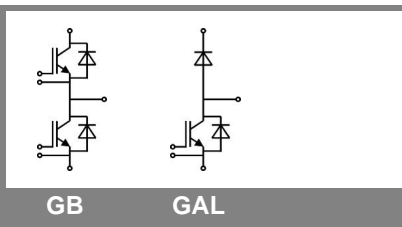

GB

GAL

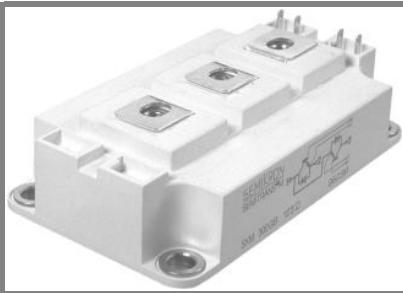

SEMITRANS® 3

Trench IGBT Modules

SKM 200GB126D

SKM 200GAL126D

Features

- Trench = Trenchgate technology
- $V_{CE(sat)}$ with positive temperature coefficient
- High short circuit capability, self limiting to $6 \times I_C$

Typical Applications*

- Electronic welders
- AC inverter drives
- UPS

Z_{th}		Values	Units
Symbol	Conditions		
$Z_{th(j-c)I}$			
$R_{\theta j-c}$	$i = 1$	95	mk/W
$R_{\theta j-c}$	$i = 2$	27	mk/W
$R_{\theta j-c}$	$i = 3$	6,7	mk/W
$R_{\theta j-c}$	$i = 4$	1,3	mk/W
$\tau_{\theta j-c}$	$i = 1$	0,0744	s
$\tau_{\theta j-c}$	$i = 2$	0,0087	s
$\tau_{\theta j-c}$	$i = 3$	0,002	s
$\tau_{\theta j-c}$	$i = 4$	0,0001	s
$Z_{th(j-c)D}$			
$R_{\theta j-c}$	$i = 1$	200	mk/W
$R_{\theta j-c}$	$i = 2$	80	mk/W
$R_{\theta j-c}$	$i = 3$	17	mk/W
$R_{\theta j-c}$	$i = 4$	3	mk/W
$\tau_{\theta j-c}$	$i = 1$	0,0536	s
$\tau_{\theta j-c}$	$i = 2$	0,0056	s
$\tau_{\theta j-c}$	$i = 3$	0,09	s
$\tau_{\theta j-c}$	$i = 4$	0,0002	s

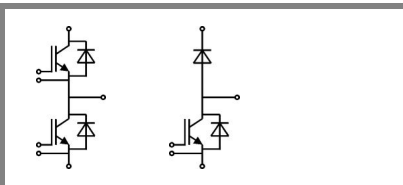

GB

GAL

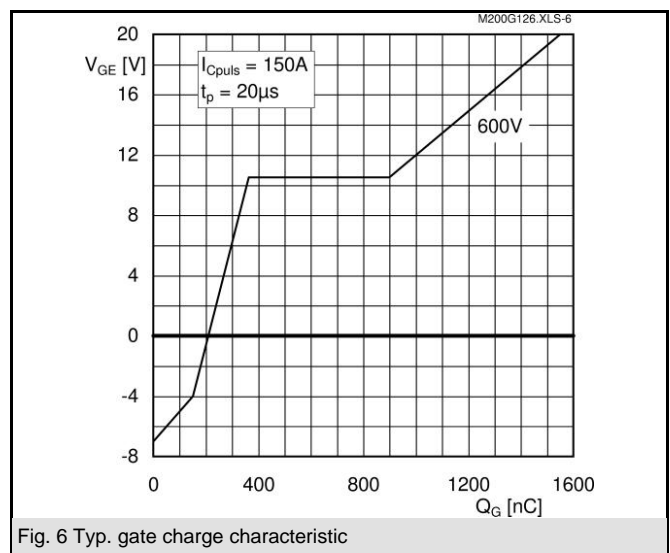
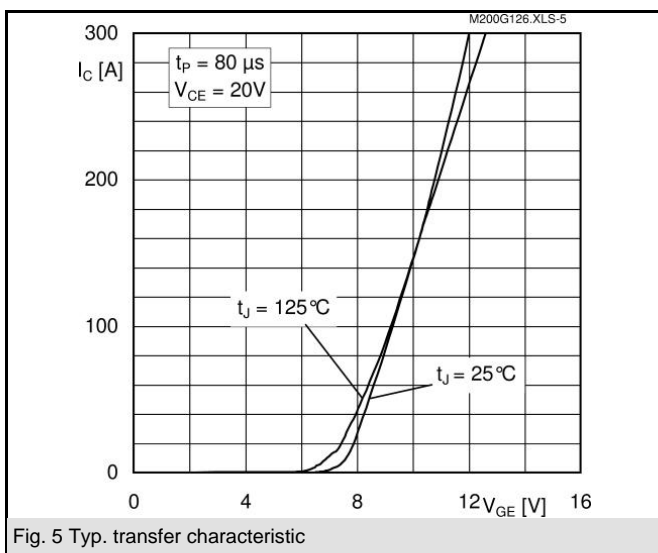
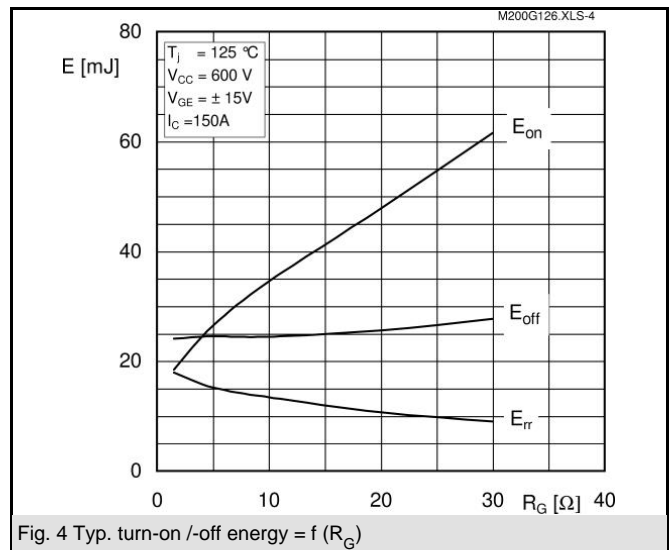
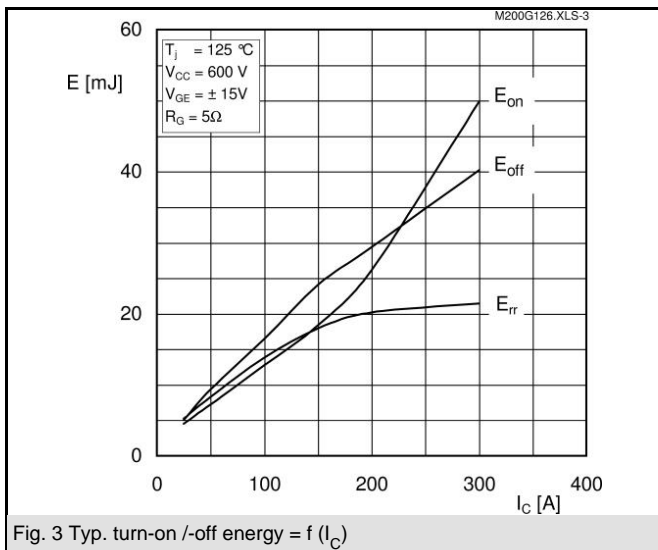
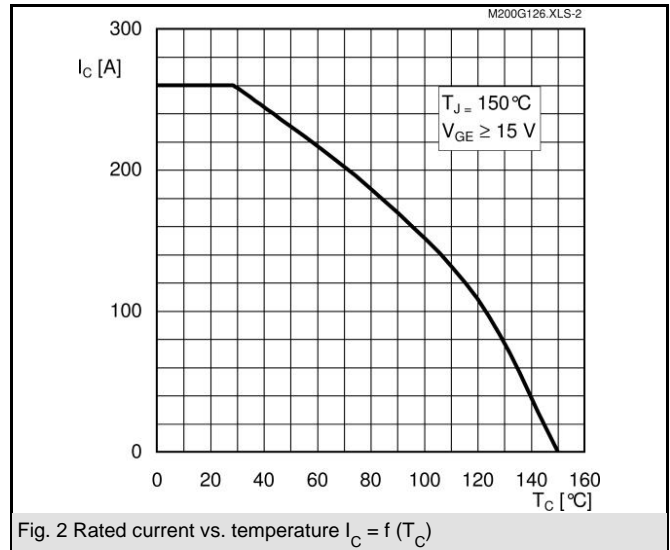
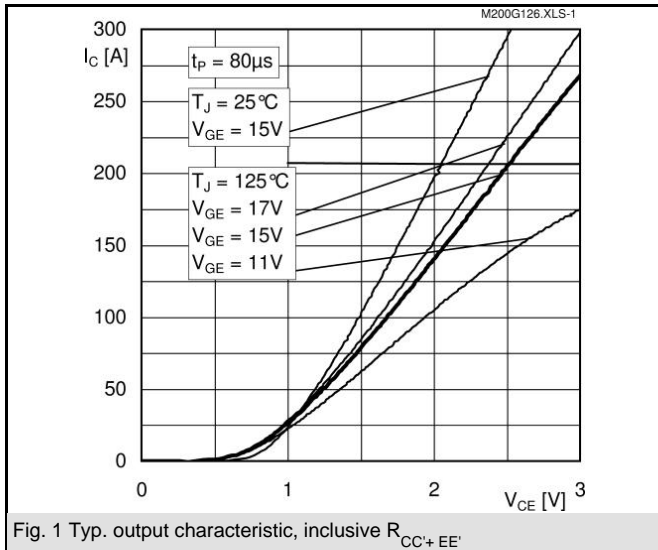

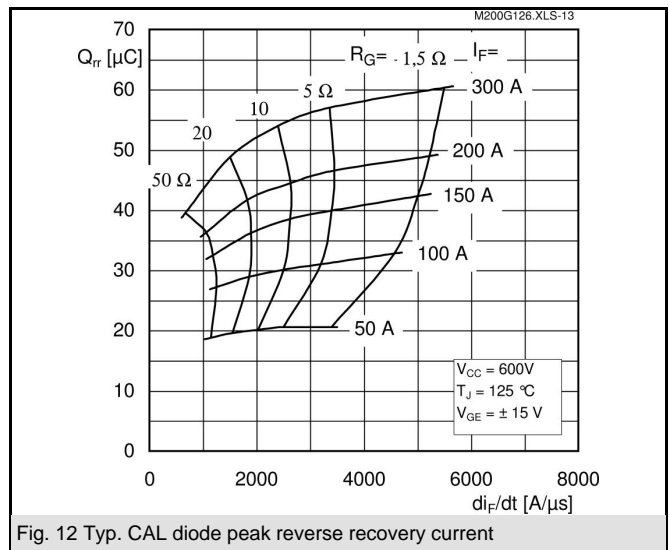
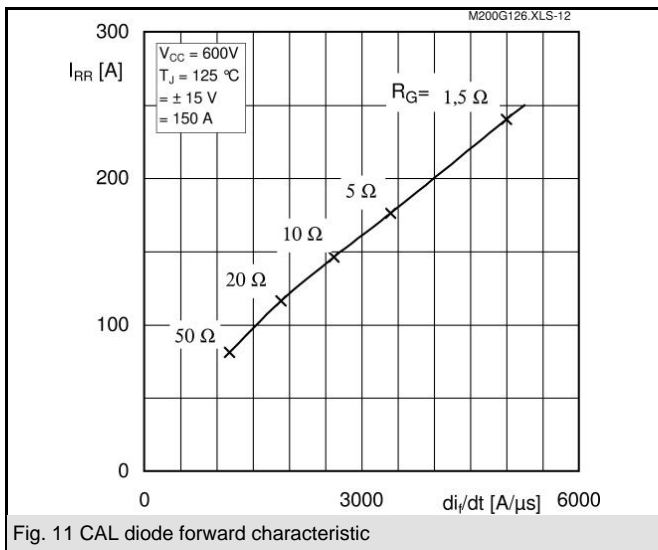
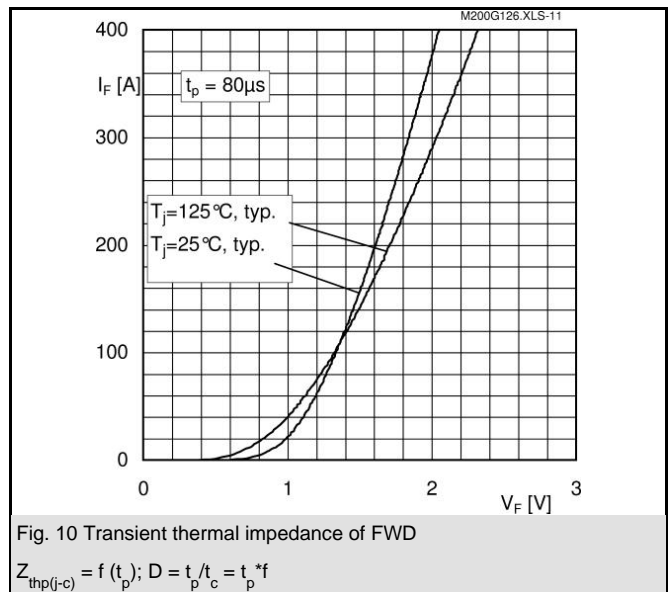
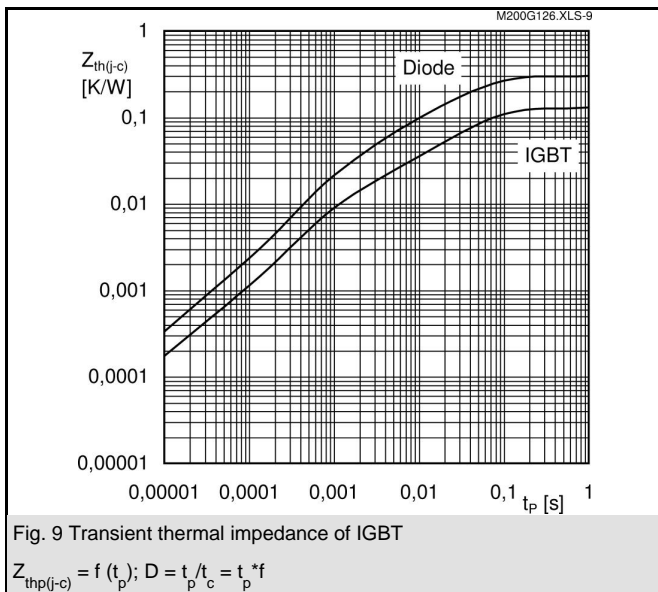
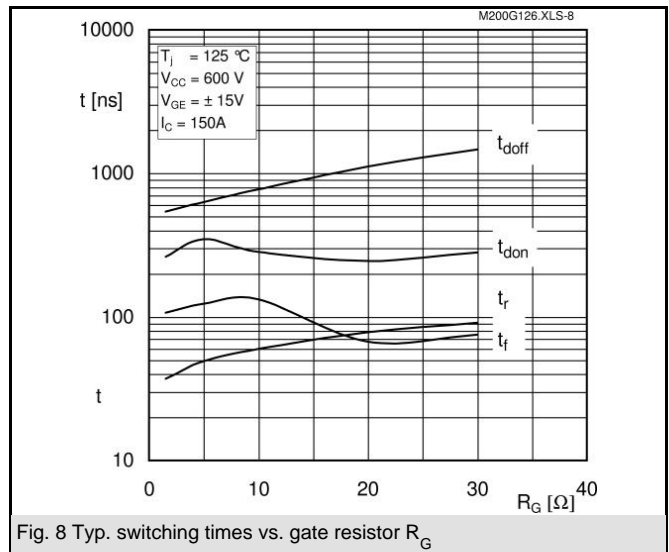
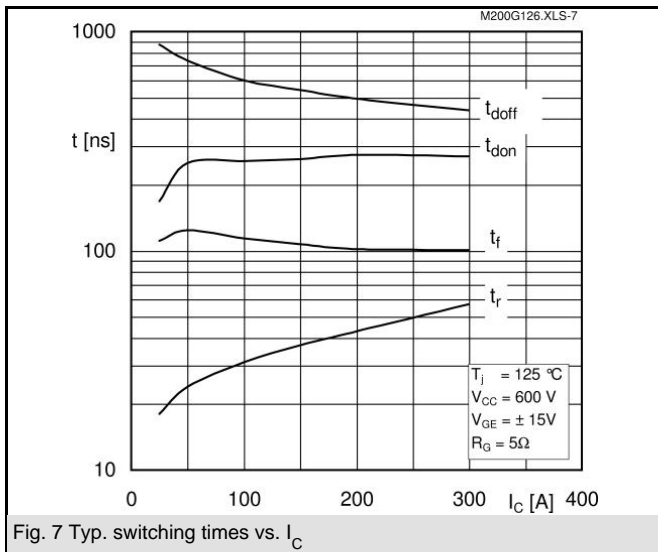

SKM 200GB126D ...

UL Recognized

CASED56

File 63 532

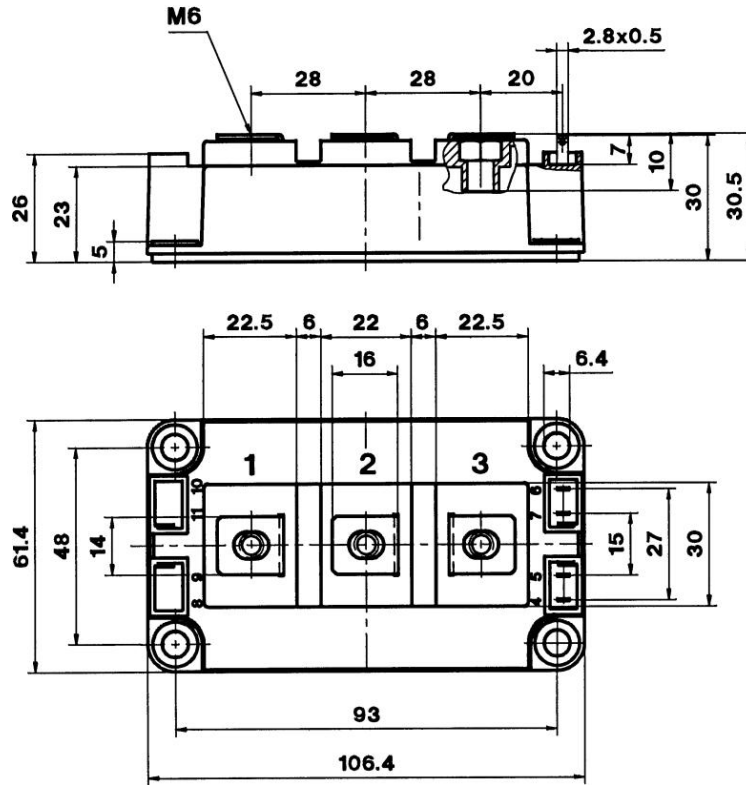

Case D 56

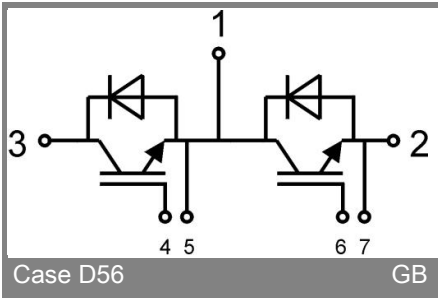

Case D56

GB

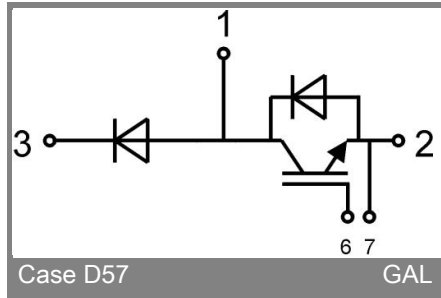

Case D57

GAL