

SKiiP 1814 GB12E4-3DUL



SKiiP® 4

2-pack-integrated intelligent Power System

SKiiP 1814 GB12E4-3DUL

Features

- Intelligent Power Module
- Integrated current and temperature measurement
- Integrated DC-link measurement
- Solder free power section
- IGBT4 and CAL4F technology
- $T_{jmax} = 175^{\circ}\text{C}$
- Safety isolated switching and sensor signals
- Digital signal transmission
- 100% tested IPM
- RoHS compliant
- UL recognition in progress, file no. E242581

Typical Applications*

- Renewable energies
- Traction
- Elevators
- Industrial drives

Remarks

For further information please refer to SKiiP@4 Technical Explanation

Absolute Maximum Ratings

Symbol	Conditions	Values	Unit
System			
V_{CC}	Operating DC link voltage	900	V
V_{isol}	DC, $t = 1$ s, each polarity	4300	V
$I_{t(RMS)}$	per AC terminal, rms, sinusoidal current	500	A
$I_{max (peak)}$	Max. peak current of power section	2700	A
f_{out}	fundamental output frequency	1	kHz
T_{stg}	storage temperature	-40 ... 85	$^{\circ}\text{C}$

IGBT

V_{CES}	$T_j = 25^{\circ}\text{C}$	1200	V
I_C	$T_j = 175^{\circ}\text{C}$	2345	A
	$T_s = 25^{\circ}\text{C}$	1906	A
	$T_s = 70^{\circ}\text{C}$	1800	A
I_{Cnom}		1800	A
T_j	junction temperature	-40 ... 175	$^{\circ}\text{C}$

Diode

V_{RRM}	$T_j = 25^{\circ}\text{C}$	1200	V
I_F	$T_j = 175^{\circ}\text{C}$	1776	A
	$T_s = 25^{\circ}\text{C}$	1408	A
	$T_s = 70^{\circ}\text{C}$	1800	A
I_{Fnom}		1800	A
T_j	junction temperature	-40 ... 175	$^{\circ}\text{C}$

Driver

V_s	power supply	19.2 ... 28.8	V
V_{iH}	input signal voltage (high)	$V_s + 0.3$	V
dv/dt	secondary to primary side	75	kV/ μs
f_{sw}	switching frequency	15	kHz

Characteristics

Symbol	Conditions	min.	typ.	max.	Unit
IGBT					
$V_{CE(sat)}$	$I_C = 1800$ A at terminal	$T_j = 25^{\circ}\text{C}$	2.01	2.26	V
		$T_j = 150^{\circ}\text{C}$	2.49	2.69	V
V_{CE0}		$T_j = 25^{\circ}\text{C}$	0.80	0.90	V
		$T_j = 150^{\circ}\text{C}$	0.70	0.80	V
r_{CE}	at terminal	$T_j = 25^{\circ}\text{C}$	0.67	0.76	m Ω
		$T_j = 150^{\circ}\text{C}$	1.00	1.05	m Ω
$E_{on} + E_{off}$	$I_C = 1800$ A	$V_{CC} = 600$ V	703		mJ
		$T_j = 150^{\circ}\text{C}$	1260		mJ
$R_{th(j-s)}$	per IGBT switch			0.021	K/W
$R_{th(j-r)}$	per IGBT switch			0.0127	K/W

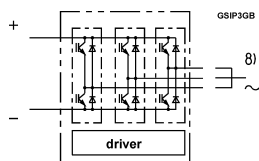

S34

SKiiP 1814 GB12E4-3DUL



SKiiP® 4

2-pack-integrated intelligent Power System

SKiiP 1814 GB12E4-3DUL

Features

- Intelligent Power Module
- Integrated current and temperature measurement
- Integrated DC-link measurement
- Solder free power section
- IGBT4 and CAL4F technology
- $T_{jmax} = 175^{\circ}\text{C}$
- Safety isolated switching and sensor signals
- Digital signal transmission
- 100% tested IPM
- RoHS compliant
- UL recognition in progress, file no. E242581

Typical Applications*

- Renewable energies
- Traction
- Elevators
- Industrial drives

Remarks

For further information please refer to SKiiP@4 Technical Explanation

Characteristics						
Symbol	Conditions		min.	typ.	max.	Unit
Diode						
$V_F = V_{EC}$	$I_F = 1800\text{ A}$ at terminal	$T_j = 25^{\circ}\text{C}$		2.33	2.65	V
		$T_j = 150^{\circ}\text{C}$		2.35	2.66	V
V_{F0}		$T_j = 25^{\circ}\text{C}$		1.30	1.50	V
		$T_j = 150^{\circ}\text{C}$		0.90	1.10	V
r_F	at terminal	$T_j = 25^{\circ}\text{C}$		0.57	0.64	m Ω
		$T_j = 150^{\circ}\text{C}$		0.81	0.87	m Ω
E_{rr}	$I_F = 1800\text{ A}$ $T_j = 150^{\circ}\text{C}$	$V_R = 600\text{ V}$		119		mJ
		$V_R = 900\text{ V}$		150		mJ
$R_{th(j-s)}$	per diode switch				0.0375	K/W
$R_{th(j-r)}$	per diode switch				0.024	K/W
Driver						
V_s	supply voltage non stabilized		19.2	24	28.8	V
I_{SO}	bias current @ $V_s = 24\text{ V}$, $f_{sw} = 0$, $I_{AC} = 0$			330		mA
I_S	$k_1 = 24\text{ mA/kHz}$, $k_2 = 0.227\text{ mA/A}$		= 330	$+ k_1 * f_{sw}$	$+ k_2 * I_{AC}$	mA
V_{IT+}	input threshold voltage (HIGH)		$0,7 * V_s$			V
V_{IT-}	Input threshold voltage (LOW)		$0,3 * V_s$			V
R_{IN}	input resistance			13		k Ω
C_{IN}	input capacitance			1		nF
t_{pRESET}	error memory reset time		1.3		2.9	s
$t_{pReset(OCP)}$	Over current reset time					μs
t_{TD}	top / bottom switch interlock time			3		μs
t_{jitter}	jitter clock time			52	58	ns
t_{SIS}	short pulse suppression time			0.6		μs
t_{POR}	Power-On-Reset completed			3.5		s
V_{CEstat}	Collector-Emitter Threshold Static Monitoring Voltage			7.5		V
t_{bl}	Collector-Emitter Threshold Static Monitoring Blanking Time			6		μs
$I_{digiout}$	digital output sink current (HALT-signal)				16	mA
$V_{it+ HALT}$	input threshold voltage HIGH HALT (Low -->High)		$0,6 * V_s$			V
$V_{it-HALT}$	input threshold voltage LOW HALT (High --> Low)				$0,4 * V_s$	V
$t_{d(Err)}$	Error delay time (from detection to HALT), (depends on kind of error)		1.8		170	μs
I_{TRIPSC}	over current trip level		2645	2700	2755	A _{PEAK}
T_{trip}	over temperature trip level		126	130	134	$^{\circ}\text{C}$
$T_{DriverTrip}$	over temperature PCB trip level		113	120	124	$^{\circ}\text{C}$
V_{DCtrip}	over voltage trip level,		950	980	1010	V
f_{0Uana}	bandwidth of DC-voltage measurement @ V_{DCtrip} (-3dB)			2		kHz
f_{0Iana}	bandwidth of current measurement @ I_{TRIPSC} (-3dB),			50		kHz
f_{0Tana}	bandwidth of temperature measurement @ T_{trip} (-3dB)			5		Hz

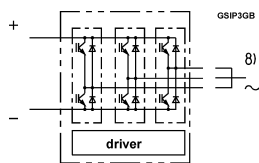

S34

SKiiP 1814 GB12E4-3DUL



SKiiP® 4

2-pack-integrated intelligent Power System

SKiiP 1814 GB12E4-3DUL

Features

- Intelligent Power Module
- Integrated current and temperature measurement
- Integrated DC-link measurement
- Solder free power section
- IGBT4 and CAL4F technology
- $T_{jmax} = 175^{\circ}\text{C}$
- Safety isolated switching and sensor signals
- Digital signal transmission
- 100% tested IPM
- RoHS compliant
- UL recognition in progress, file no. E242581

Typical Applications*

- Renewable energies
- Traction
- Elevators
- Industrial drives

Remarks

For further information please refer to SKiiP®4 Technical Explanation

Characteristics						
Symbol	Conditions		min.	typ.	max.	Unit
System						
$t_{d(on)IO}$	$V_{CC} = 600\text{ V}$ $I_C = 1800\text{ A}$ $T_j = 25^{\circ}\text{C}$	turn on propagation delay time		2.8		μs
$t_{d(off)IO}$		turn off propagation delay time		2.6		μs
dV_{CE}/dt_{on}	$T_j = 25^{\circ}\text{C}$ $V_{CC} = 600\text{ V}$	$I_C = 0\text{ A}$		9		$\text{kV}/\mu\text{s}$
		$I_C = 1800\text{ A}$		3		$\text{kV}/\mu\text{s}$
dV_{CE}/dt_{off}		$I_C = 1800\text{ A}$		4		$\text{kV}/\mu\text{s}$
$R_{th(s-a)}$	flow rate = $610\text{ m}^3/\text{h}$, $T_a=25^{\circ}\text{C}$, 500m above sea level				0.026	K/W
R_{CC+EE}	terminals to chip, $T_s = 25^{\circ}\text{C}$			0.09		$\text{m}\Omega$
L_{CE}	commutation inductance			6		nH
C_{CHC}	coupling capacitance secondary to heat sink			4.8		nF
C_{ps}	coupling capacitance primary to secondary			0.067		nF
$I_{CES} + I_{RD}$	$V_{GE} = 0\text{ V}$, $V_{CE} = 1200\text{ V}$, $T_j = 25^{\circ}\text{C}$			0.157		mA
M_{dc}	DC terminals		6		8	Nm
M_{ac}	AC terminals		13		15	Nm
w	SKiiP System w/o heat sink			2.48		kg
W_h	heat sink			5.9		kg

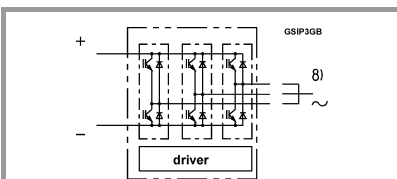

S34

SKiIP 1814 GB12E4-3DUL

Isolation coordination acc. to EN 50178 and IEC 61800-5-1	
Maximum grid RMS voltage, line-to-line, grounded delta mains	480V+20%
Installation altitude for maximum grid RMS voltage, line-to-line, grounded delta mains	4000m
Maximum grid RMS voltage, line-to-line, star point grounded mains	480V+20%
Installation altitude for maximum grid RMS voltage, line-to-line, star point grounded mains	8000m
Maximum transient peak voltage between low voltage circuit and mains	1900V
Pollution degree acc. to IEC 60664-1 outside the moulded power section	2
Overtoltage cat. acc. to IEC 60664-1 for mains	III
Overtoltage cat. acc. to UL 840 within mains	I
Overtoltage cat. acc. to UL 840 between mains and ground	III
Overtoltage cat. acc. to UL 840 between mains and low voltage circuit	III
Basic isolation	between heat sink and mains
Reinforced isolation	between low voltage circuit and mains
Protection level acc. to IEC 60529	IP00

Environmental conditions acc. to IEC 60721

	Storage	Transportation	Operation - stationary use at weatherprotected locations	Operation - ground vehicle installations	Operation - ship environment
Climatic conditions	1K2	2K2	3K3 ₍₁₎	5K1	6K1
Biological conditions	1B1	2B1	3B1	5B1	6B1
Chemically active substances (excluded: salt spray)	1C2	2C1	3C2	5C2	6C2
Mechanically active substances	1S1	2S1	3S1	5S1	6S1
Mechanical conditions	1M3	(4)	3M6 ₍₂₎	5M3 ₍₃₎	6M3
Contaminating fluids	---	---	---	5F1	---

(1) 3K3: expanded temperature range: -40°C / +85°C

(2) 3M7 possible, but due to mechanic load capacity of external components like DC-Link capacitors limited to 3M6

(3) 5M3, shock only 5M2, without impact from foreign bodies, stones

(4) no declaration due to customer-specific packing

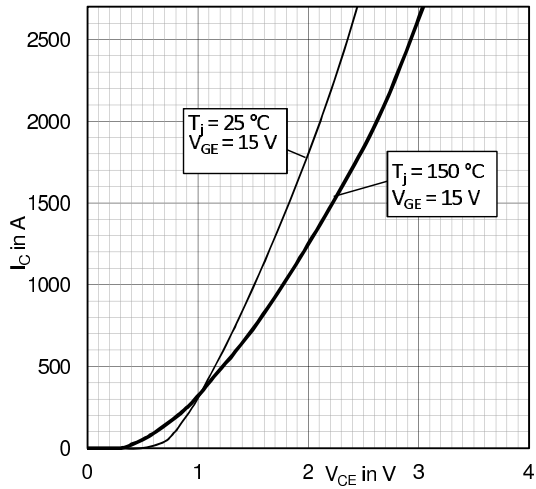

Fig. 1: Typical IGBT output characteristics

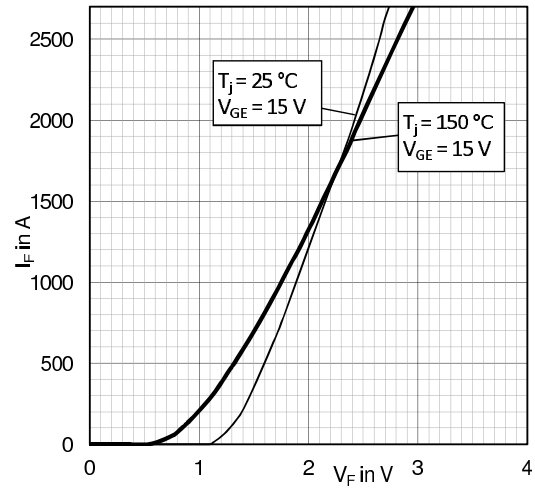

Fig. 2: Typical diode output characteristics

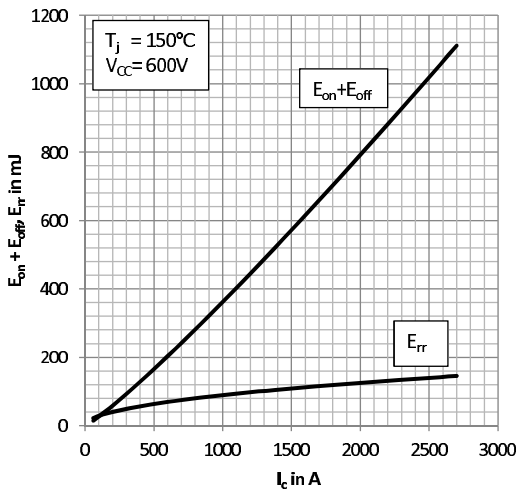

Fig. 3: Typical energy losses $E = f(I_C, V_{CC}, T_j)$

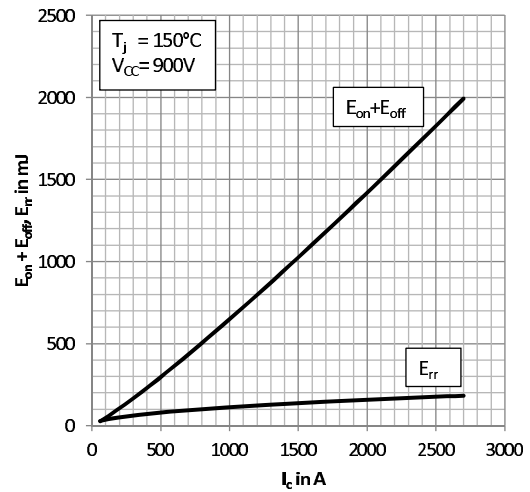

Fig. 4: Typical energy losses $E = f(I_C, V_{CC}, T_j)$

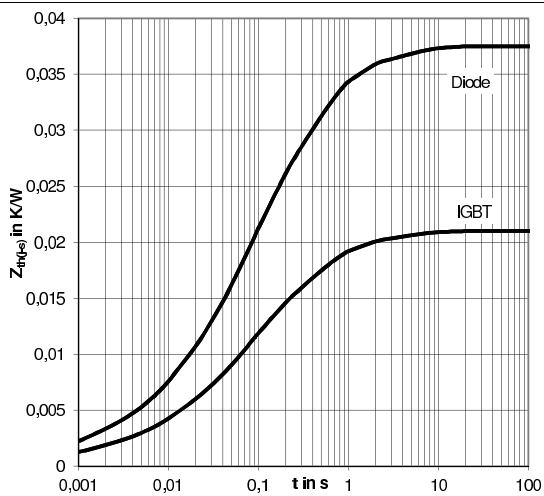

Fig. 5: Transient thermal impedance $Z_{th}(j-s)$

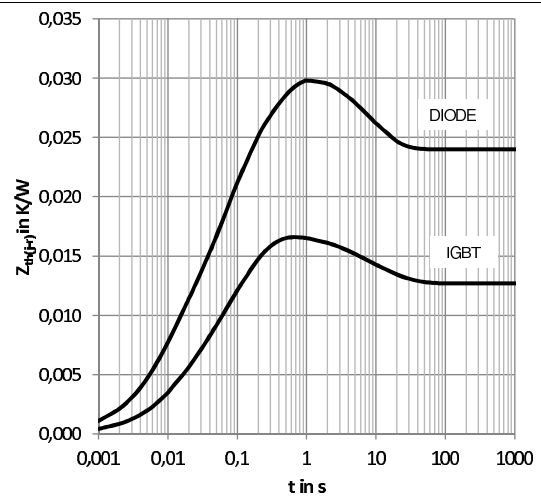

Fig. 6: Transient thermal impedance $Z_{th}(j-r)$

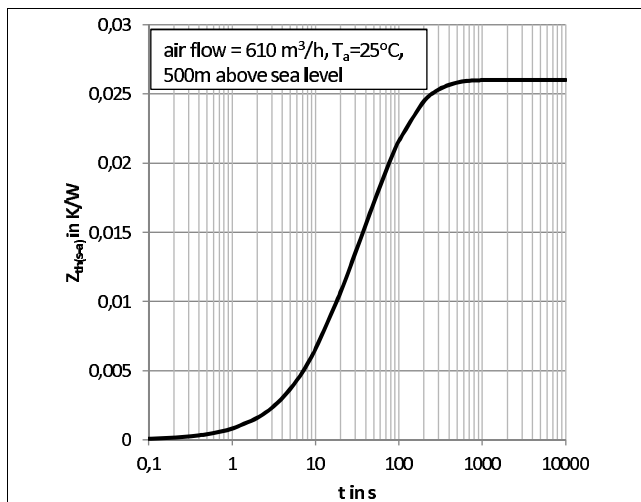

Fig. 7: Transient thermal impedance $Z_{th}(s-a)$

	$R_{th} [K/W]$				
	1	2	3	4	5
$Z_{th}(f-s) I$	0,0013	0,0065	0,0073	0,0022	0,0010
$Z_{th}(f-s) D$	0,0026	0,0134	0,0149	0,0045	0,0021
$Z_{th}(f-r) I$	0,0035	0,0048	0,0087	-0,0018	-0,0025
$Z_{th}(f-r) D$	0,0077	0,0135	0,0098	-0,0070	
$Z_{th}(s-a)$	0,0069	0,0147	0,0044		
	$\tau [s]$				
	1	2	3	4	5
$Z_{th}(f-s) I$	3,6500	0,4100	0,0650	0,0090	0,0008
$Z_{th}(f-s) D$	3,6500	0,4100	0,0650	0,0090	0,0008
$Z_{th}(f-r) I$	0,0120	0,0470	0,1400	4,9000	16,000
$Z_{th}(f-r) D$	0,0084	0,0600	0,3200	8,6000	
$Z_{th}(s-a)$	13,200	51,000	157,00		

Fig. 8: Coefficients of thermal impedances

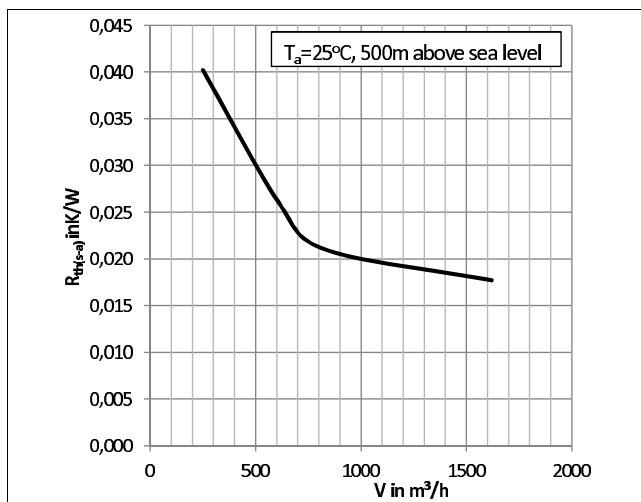

Fig. 9: Thermal resistance $R_{th}(s-a)$ versus flow rate V

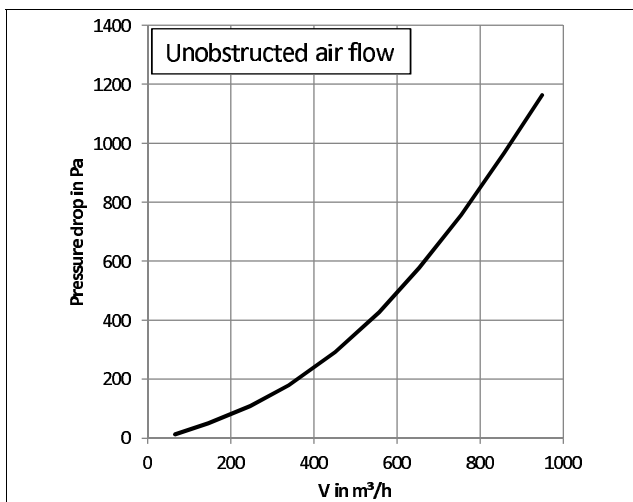
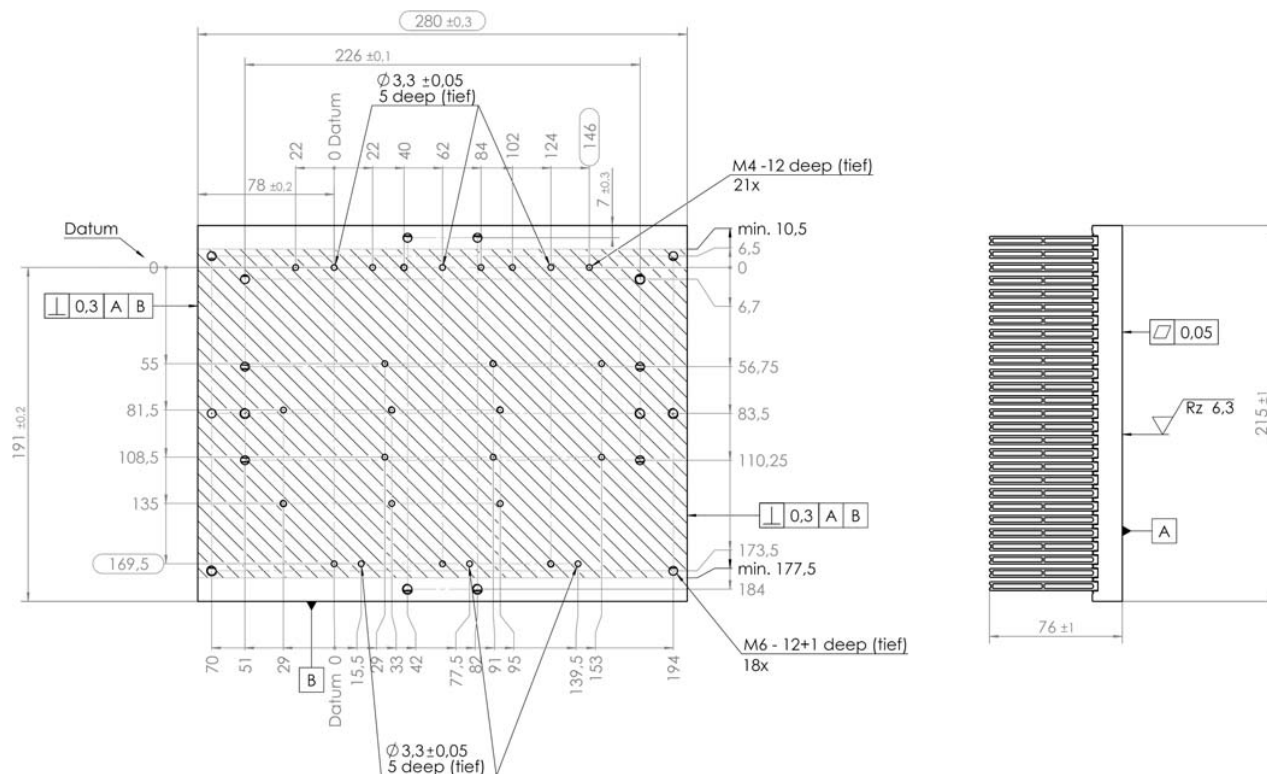

Fig. 10: Pressure drop Δp versus flow rate V

SKiiP 1814 GB12E4-3DUL



Heat sink

SKiIP 1814 GB12E4-3DUL

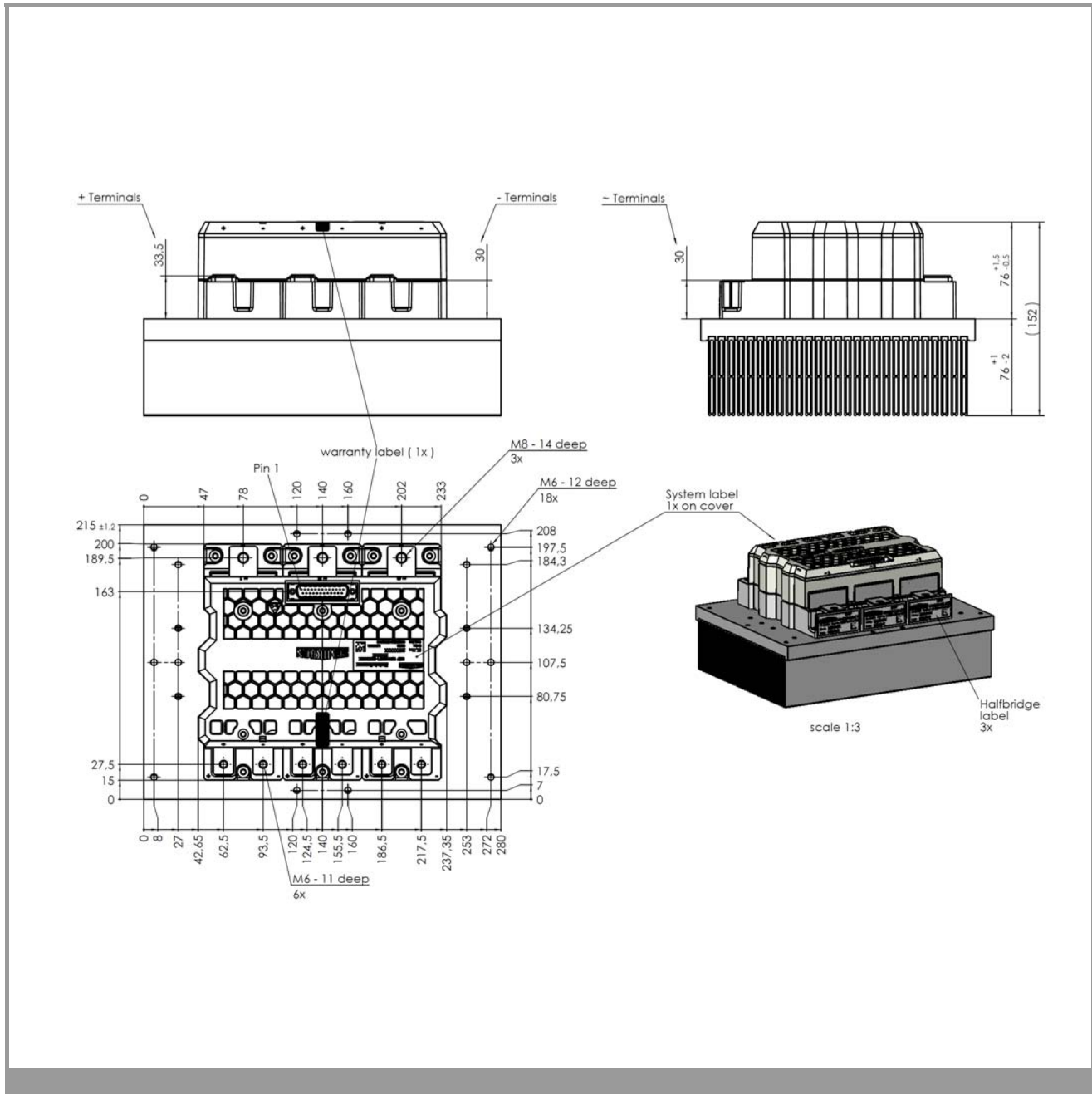

This is an electrostatic discharge sensitive device (ESDS), international standard IEC 60747-1, Chapter IX

* The specifications of our components may not be considered as an assurance of component characteristics. Components have to be tested for the respective application. Adjustments may be necessary. The use of SEMIKRON products in life support appliances and systems is subject to prior specification and written approval by SEMIKRON. We therefore strongly recommend prior consultation of our staff.