

# SKiM 200GD126D ...



SKiM<sup>®</sup> 4

## IGBT Modules

### SKiM 200GD126D

Data

#### Features

- Trench gate IGBT with field stop layer
- Low inductance case
- Fast & soft inverse CAL diode
- Isolated by Al<sub>2</sub>O<sub>3</sub> DCB (Direct Copper Bonded) ceramic plate
- Pressure contact technology for thermal contacts
- Spring contact system to attach driver PCB to the control terminals
- Integrated temperature sensor

#### Typical Applications\*

- Switched mode power supplies
- Uninterruptable Power Supplies (UPS)
- Three phase inverters for AC motor speed control

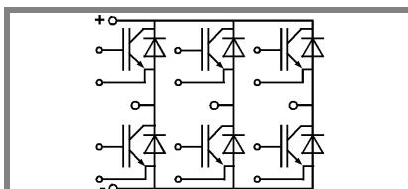

GD

Absolute Maximum Ratings		T <sub>case</sub> = 25°C, unless otherwise specified	
Symbol	Conditions	Values	Units
<b>IGBT</b>			
V <sub>CES</sub>		1200	V
I <sub>C</sub>	T <sub>s</sub> = 25 (70) °C	180 (140)	A
I <sub>CRM</sub>	t <sub>p</sub> = 1 ms	400	A
V <sub>GES</sub>		± 20	V
T <sub>j</sub> (T <sub>stg</sub> )		- 40 ... + 150 (125)	°C
T <sub>cop</sub>	max. case operating temperature	125	°C
V <sub>isol</sub>	AC, 1 min.	2500	V
<b>Inverse diode</b>			
I <sub>F</sub>	T <sub>s</sub> = 25 (70) °C	200 (130)	A
I <sub>FRM</sub>	t <sub>p</sub> = 1 ms	400	A
I <sub>FSM</sub>	t <sub>p</sub> = 10 ms; sin.; T <sub>j</sub> = 150 °C	1400	A

Characteristics		T <sub>case</sub> = 25°C, unless otherwise specified			
Symbol	Conditions	min.	typ.	max.	Units
<b>IGBT</b>					
V <sub>GE(th)</sub>	V <sub>GE</sub> = V <sub>CE</sub> ; I <sub>C</sub> = 8 mA	5	5,8	6,5	V
I <sub>CES</sub>	V <sub>GE</sub> = 0; V <sub>CE</sub> = V <sub>CES</sub> ; T <sub>j</sub> = 25 °C		0,1	0,3	mA
V <sub>CEO</sub>	T <sub>j</sub> = 25 (125) °C		1 (0,9)	1,2 (1,1)	V
r <sub>CE</sub>	T <sub>j</sub> = 25 (125) °C		3,3 (5,3)	4,5 (6,5)	mΩ
V <sub>CEsat</sub>	I <sub>Cnom</sub> = 200 A; V <sub>GE</sub> = 15 V; T <sub>j</sub> = 25 (125) °C on chip level		1,65 (1,95)	2,1 (2,4)	V
C <sub>ies</sub>	V <sub>GE</sub> = 0; V <sub>CE</sub> = 25 V; f = 1 MHz		15		nF
C <sub>oes</sub>	V <sub>GE</sub> = 0; V <sub>CE</sub> = 25 V; f = 1 MHz		1,2		nF
C <sub>res</sub>	V <sub>GE</sub> = 0; V <sub>CE</sub> = 25 V; f = 1 MHz		1,1		nF
L <sub>CE</sub>				15	nH
R <sub>CC'+EE'</sub>	resistance, terminal-chip T <sub>c</sub> = 25 (125) °C		1,35 (1,75)		mΩ
t <sub>d(on)</sub>	V <sub>CC</sub> = 600 V				ns
t <sub>r</sub>	I <sub>Cnom</sub> = 200 A				ns
t <sub>d(off)</sub>	R <sub>Gon</sub> = R <sub>Goff</sub> = 6,8 Ω				ns
t <sub>f</sub>	T <sub>j</sub> = 125 °C				ns
E <sub>on</sub> (E <sub>off</sub> )	V <sub>GE</sub> ± 15 V		15 (25)		mJ
E <sub>on</sub> (E <sub>off</sub> )	with SKHI 64; T <sub>j</sub> = 125 °C				mJ
	V <sub>CC</sub> = 600 V; I <sub>C</sub> = 200 A				
<b>Inverse diode</b>					
V <sub>F</sub> = V <sub>EC</sub>	I <sub>Fnom</sub> = 150 A; V <sub>GE</sub> = 0 V; T <sub>j</sub> = 25 (125) °C		2 (1,8)	2,5 (2,3)	V
V <sub>TO</sub>	T <sub>j</sub> = 25 (125) °C		1,1	1,45 (1,25)	V
r <sub>T</sub>	T <sub>j</sub> = 25 (125) °C		6	7 (7)	mΩ
I <sub>RRM</sub>	I <sub>F</sub> = 150 A; T <sub>j</sub> = 125 °C				A
Q <sub>rr</sub>	V <sub>GE</sub> = 0 V di/dt = A/μs				μC
E <sub>rr</sub>	R <sub>Gon</sub> = R <sub>Goff</sub> = 6,8 Ω				mJ
<b>Thermal characteristics</b>					
R <sub>th(j-s)</sub>	per IGBT			0,28	K/W
R <sub>th(j-s)</sub>	per FWD			0,35	K/W
<b>Temperature Sensor</b>					
R <sub>TS</sub>	T = 25 (100) °C		1 (1,67)		kΩ
tolerance	T = 25 (100) °C		3 (2)		%
<b>Mechanical data</b>					
M <sub>1</sub>	to heatsink (M5)	2		3	Nm
M <sub>2</sub>	for terminals (M6)	4		5	Nm
w				310	g

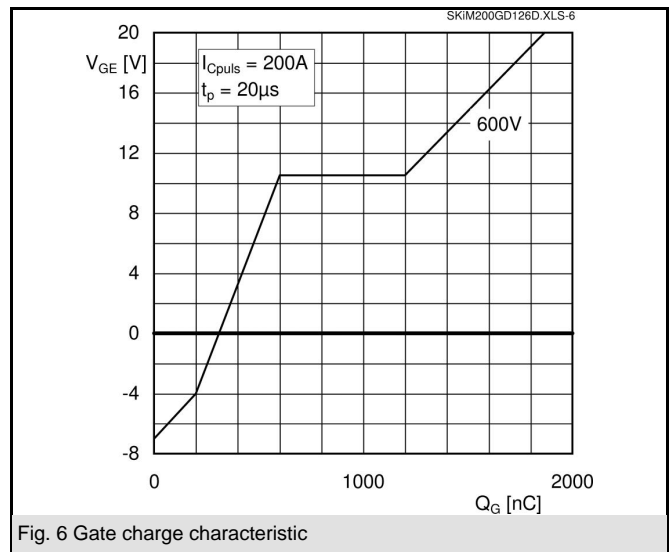
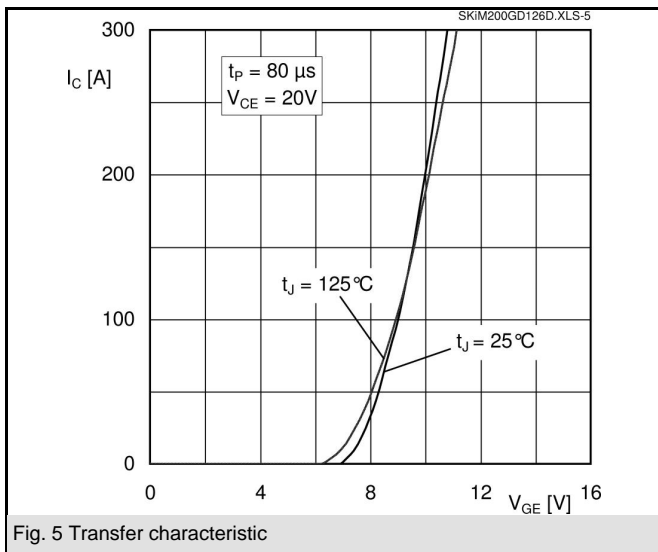
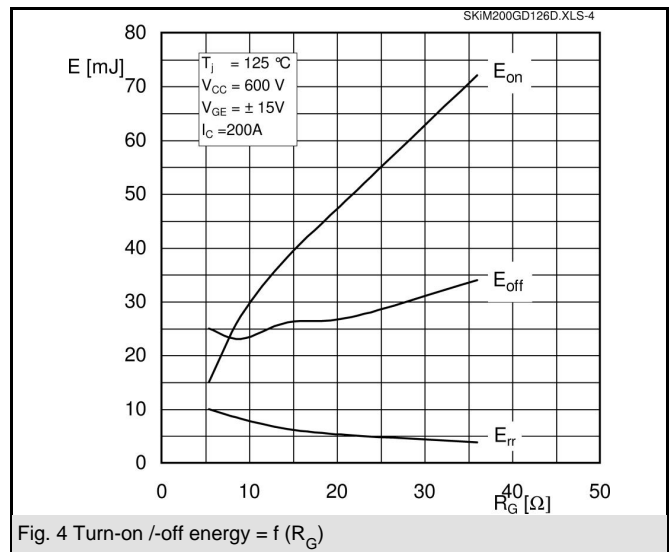
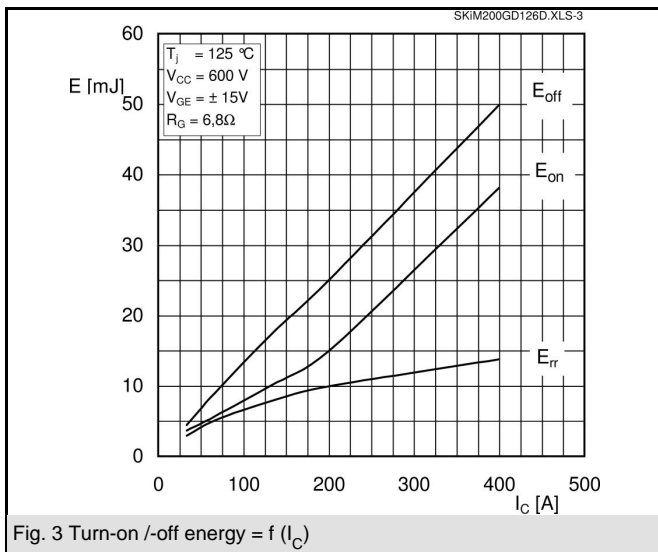
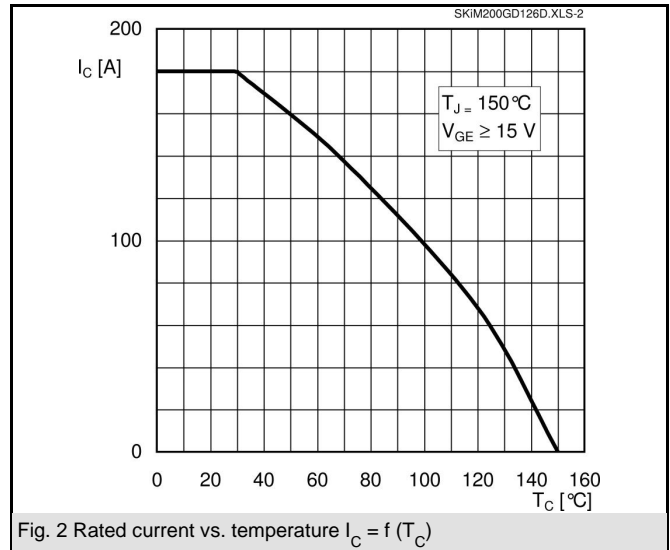
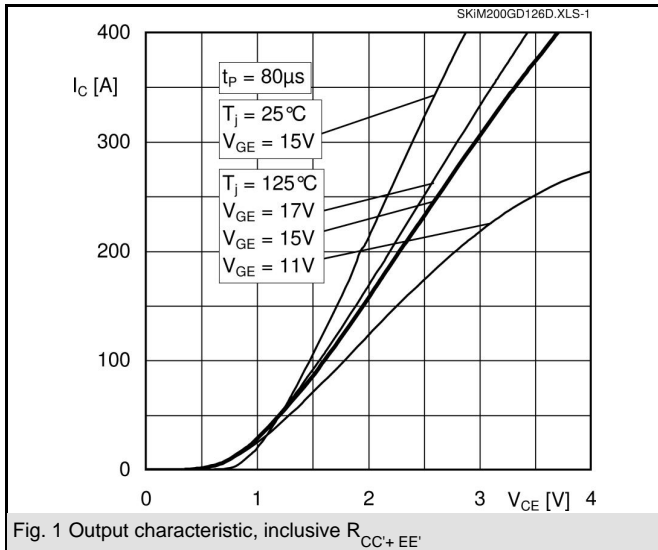

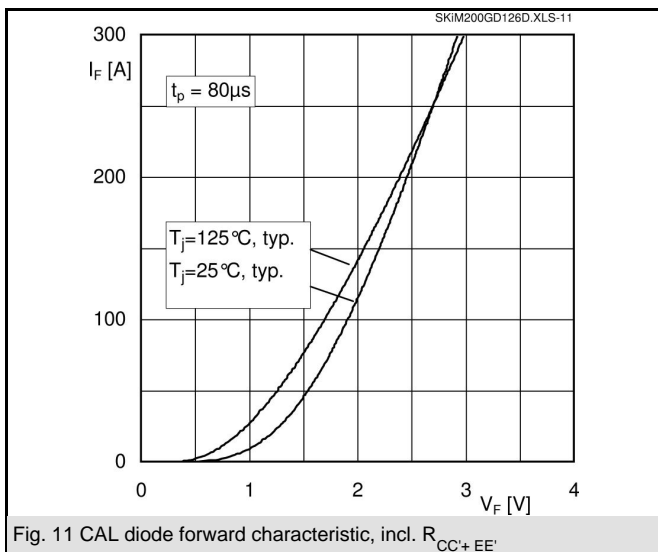
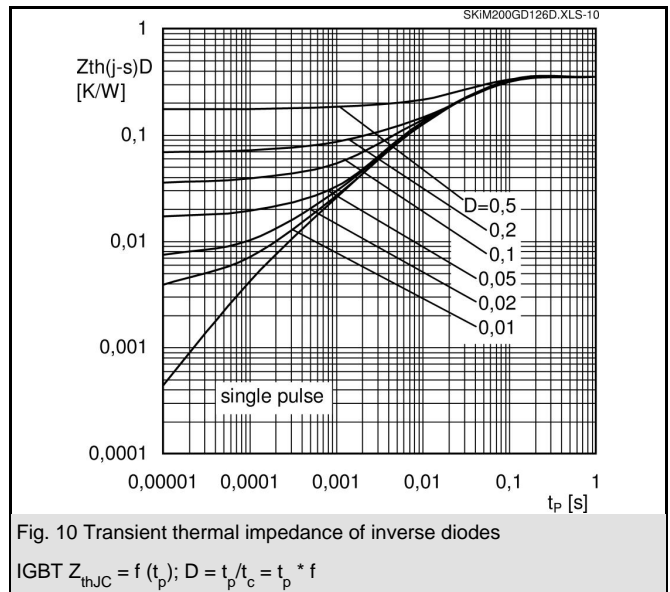
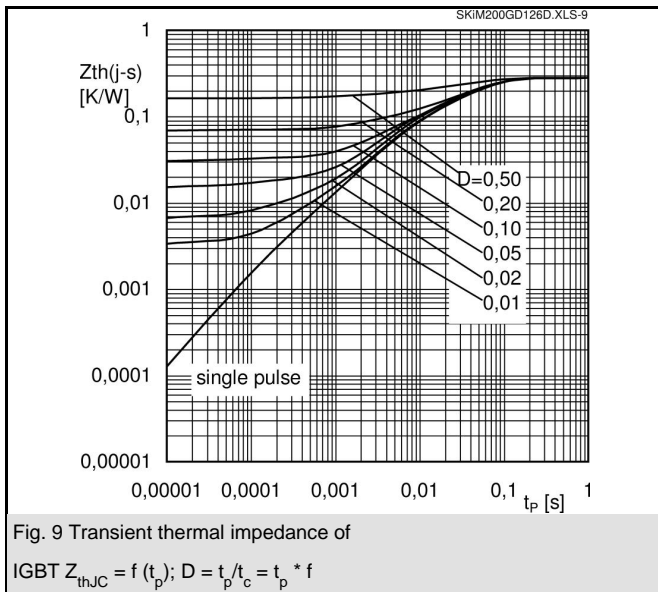

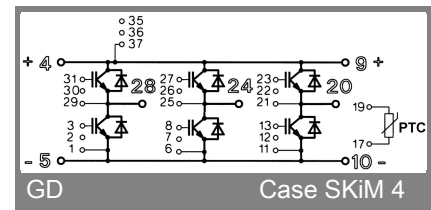
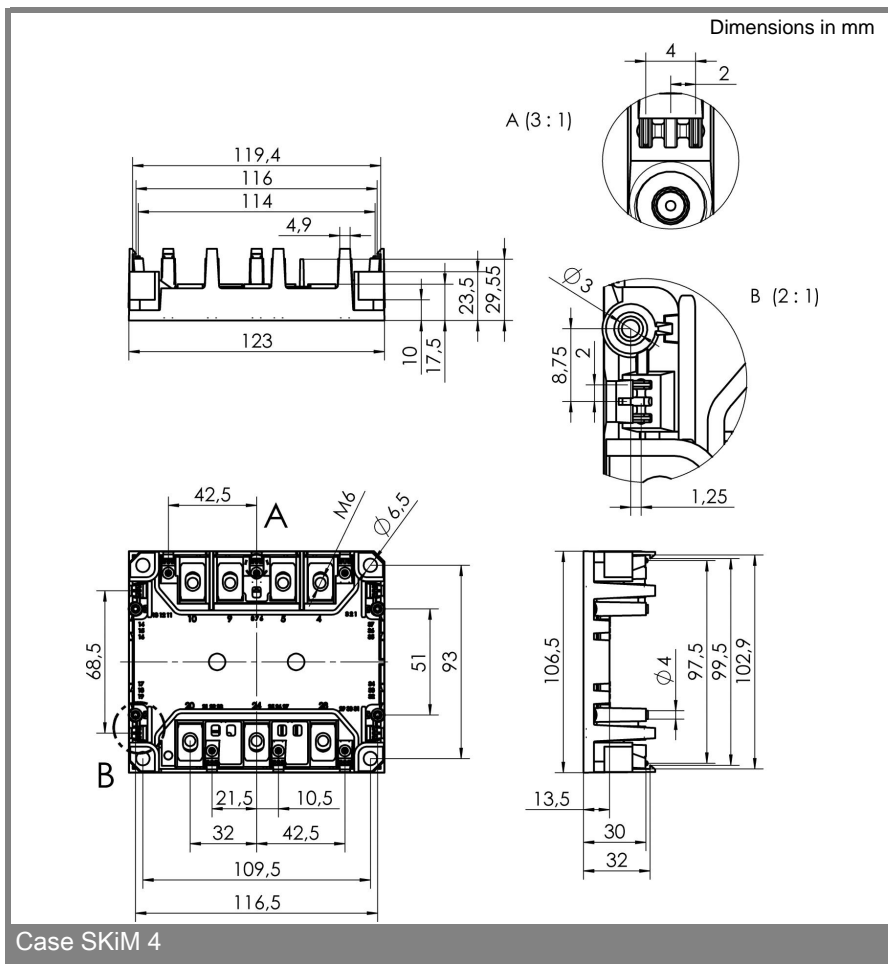

This is an electrostatic discharge sensitive device (ESDS), international standard IEC 60747-1, Chapter IX.

\* The specifications of our components may not be considered as an assurance of component characteristics. Components have to be tested for the respective application. Adjustments may be necessary. The use of SEMIKRON products in life support appliances and systems is subject to prior specification and written approval by SEMIKRON. We therefore strongly recommend prior consultation of our personal.