

# SKM 400GB176D

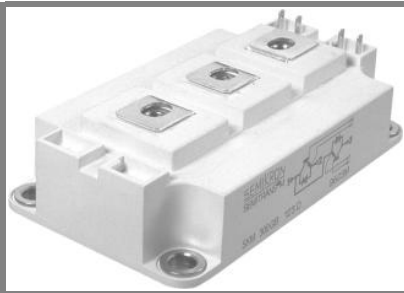

**SEMITRANS® 3**

## Trench IGBT Modules

**SKM 400GB176D**

**SKM 400GAL176D**

### Features

- Homogeneous Si
- Trench = Trenchgate technology
- $V_{CE(sat)}$  with positive temperature coefficient
- High short circuit capability, self limiting to  $6 \times I_C$

### Typical Applications\*

- AC inverter drives
- mains 575 - 750 V AC
- Public transport (auxiliary syst.)
- Wind power

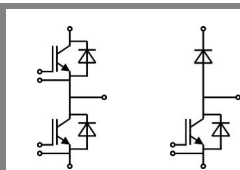

**GB**

**GAL**

Absolute Maximum Ratings		$T_{case} = 25^\circ\text{C}$ , unless otherwise specified		
Symbol	Conditions	Values	Units	
<b>IGBT</b>				
$V_{CES}$	$T_j = 25^\circ\text{C}$	1700	V	
$I_C$	$T_j = 150^\circ\text{C}$	$T_c = 25^\circ\text{C}$	430	A
		$T_c = 80^\circ\text{C}$	310	A
$I_{CRM}$	$I_{CRM} = 2 \times I_{Cnom}$	600	A	
$V_{GES}$		$\pm 20$	V	
$t_{psc}$	$V_{CC} = 1200\text{ V}; V_{GE} \leq 20\text{ V}; T_j = 125^\circ\text{C}$ $V_{CES} < 1700\text{ V}$	10	$\mu\text{s}$	

Inverse Diode		$T_c = 25^\circ\text{C}$		$T_c = 80^\circ\text{C}$	
Symbol	Conditions	Values	Units	Values	Units
$I_F$	$T_j = 150^\circ\text{C}$	440	A	300	A
		300	A		
$I_{FRM}$	$I_{FRM} = 2 \times I_{Fnom}$	600	A		
$I_{FSM}$	$t_p = 10\text{ ms}; \text{sin.}$	2200	A		

Freewheeling Diode		$T_{case} = 25^\circ\text{C}$		$T_{case} = 80^\circ\text{C}$	
Symbol	Conditions	Values	Units	Values	Units
$I_F$	$T_j = 150^\circ\text{C}$	440	A	300	A
		300	A		
$I_{FRM}$	$I_{FRM} = 2 \times I_{Fnom}$	600	A		
$I_{FSM}$	$t_p = 10\text{ ms}; \text{sin.}$	2200	A		

Module		Values	Units
$I_{l(RMS)}$		500	A
$T_{vj}$		- 40 ... + 150	$^\circ\text{C}$
$T_{stg}$		- 40 ... + 125	$^\circ\text{C}$
$V_{isol}$	AC, 1 min.	4000	V

Characteristics		$T_{case} = 25^\circ\text{C}$ , unless otherwise specified			
Symbol	Conditions	min.	typ.	max.	Units
<b>IGBT</b>					
$V_{GE(th)}$	$V_{GE} = V_{CE}, I_C = 12\text{ mA}$	5,2	5,8	6,4	V
$I_{CES}$	$V_{GE} = 0\text{ V}, V_{CE} = V_{CES}$			4	mA
$V_{CE0}$		$T_j = 25^\circ\text{C}$	1	1,2	V
		$T_j = 125^\circ\text{C}$	0,9	1,1	V
$r_{CE}$	$V_{GE} = 15\text{ V}$	$T_j = 25^\circ\text{C}$	3,3	4,2	$\text{m}\Omega$
		$T_j = 125^\circ\text{C}$	5,2	6	$\text{m}\Omega$
$V_{CE(sat)}$	$I_{Cnom} = 300\text{ A}, V_{GE} = 15\text{ V}$	$T_j = 25^\circ\text{C}_{\text{chiplev.}}$	2	2,4	V
		$T_j = 125^\circ\text{C}_{\text{chiplev.}}$	2,45	2,9	V
$C_{ies}$	$V_{CE} = 25, V_{GE} = 0\text{ V}$	$f = 1\text{ MHz}$	19,8		nF
$C_{oes}$			1,1		nF
$C_{res}$			0,88		nF
$Q_G$	$V_{GE} = -8\text{V} \dots +15\text{V}$		2500		nC
$t_{d(on)}$	$R_{Gon} = 4\ \Omega$	$V_{CC} = 1200\text{V}$ $I_C = 300\text{A}$	330		ns
$t_r$			55		ns
$E_{on}$	$R_{Goff} = 4\ \Omega$	$T_j = 125^\circ\text{C}$ $V_{GE} = \pm 15\text{V}$	170		mJ
$t_{d(off)}$			880		ns
$t_f$			145		ns
$E_{off}$			118		mJ
$R_{th(j-c)}$	per IGBT			0,075	K/W

# SKM 400GB176D

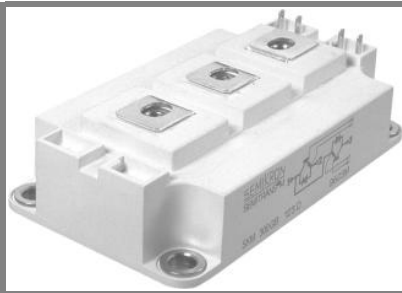

SEMITRANS® 3

## Trench IGBT Modules

SKM 400GB176D

SKM 400GAL176D

### Features

- Homogeneous Si
- Trench = Trenchgate technology
- $V_{CE(sat)}$  with positive temperature coefficient
- High short circuit capability, self limiting to  $6 \times I_C$

### Typical Applications\*

- AC inverter drives
- mains 575 - 750 V AC
- Public transport (auxiliary syst.)
- Wind power

Characteristics					
Symbol	Conditions	min.	typ.	max.	Units
<b>Inverse Diode</b>					
$V_F = V_{EC}$	$I_{Fnom} = 300 \text{ A}; V_{GE} = 0 \text{ V}$	$T_j = 25 \text{ }^\circ\text{C}_{chiplev.}$	1,7	1,9	V
		$T_j = 125 \text{ }^\circ\text{C}_{chiplev.}$	1,8	2	V
$V_{F0}$		$T_j = 25 \text{ }^\circ\text{C}$	1,2	1,4	V
		$T_j = 125 \text{ }^\circ\text{C}$	0,9	1,1	V
$r_F$		$T_j = 25 \text{ }^\circ\text{C}$	1,7	1,7	mΩ
		$T_j = 125 \text{ }^\circ\text{C}$	3	3	mΩ
$I_{RRM}$	$I_F = 300 \text{ A}$	$T_j = 125 \text{ }^\circ\text{C}$	418		A
$Q_{rr}$	$di/dt = 5800 \text{ A}/\mu\text{s}$		117		μC
$E_{tr}$	$V_{GE} = -15 \text{ V}; V_{CC} = 1200 \text{ V}$		78		mJ
$R_{th(j-c)D}$	per diode			0,125	K/W
<b>FWD</b>					
$V_F = V_{EC}$	$I_{Fnom} = 300 \text{ A}; V_{GE} = 0 \text{ V}$	$T_j = 25 \text{ }^\circ\text{C}_{chiplev.}$	1,7	1,9	V
		$T_j = 125 \text{ }^\circ\text{C}_{chiplev.}$	1,8	2	V
$V_{F0}$		$T_j = 25 \text{ }^\circ\text{C}$	1,2	1,4	V
		$T_j = 125 \text{ }^\circ\text{C}$	0,9	1,1	V
$r_F$		$T_j = 25 \text{ }^\circ\text{C}$	1,7	1,7	V
		$T_j = 125 \text{ }^\circ\text{C}$	3	3	V
$I_{RRM}$	$I_F = 300 \text{ A}$	$T_j = 125 \text{ }^\circ\text{C}$	418		A
$Q_{rr}$	$di/dt = 5800 \text{ A}/\mu\text{s}$		117		μC
$E_{tr}$	$V_{GE} = -15 \text{ V}; V_{CC} = 1200 \text{ V}$		78		mJ
$R_{th(j-c)FD}$	per diode			0,125	K/W
<b>Module</b>					
$L_{CE}$			15	20	nH
$R_{CC'+EE'}$	res., terminal-chip	$T_{case} = 25 \text{ }^\circ\text{C}$	0,35		mΩ
		$T_{case} = 125 \text{ }^\circ\text{C}$	0,5		mΩ
$R_{th(c-s)}$	per module			0,038	K/W
$M_s$	to heat sink M6		3	5	Nm
$M_t$	to terminals M6		2,5	5	Nm
w				325	g

This is an electrostatic discharge sensitive device (ESDS), international standard IEC 60747-1, Chapter IX.

\* The specifications of our components may not be considered as an assurance of component characteristics. Components have to be tested for the respective application. Adjustments may be necessary. The use of SEMIKRON products in life support appliances and systems is subject to prior specification and written approval by SEMIKRON. We therefore strongly recommend prior consultation of our personal.

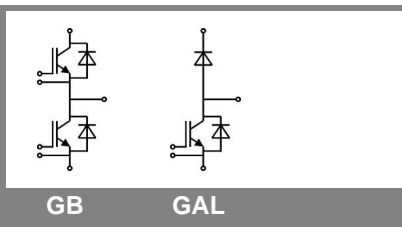

GB

GAL

# SKM 400GB176D

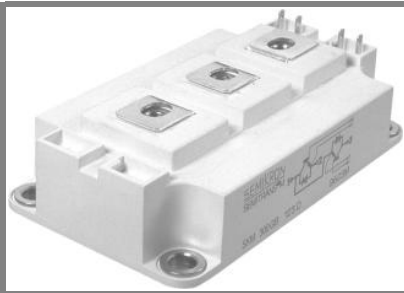

**SEMITRANS<sup>®</sup> 3**

## Trench IGBT Modules

**SKM 400GB176D**

**SKM 400GAL176D**

### Features

- Homogeneous Si
- Trench = Trenchgate technology
- $V_{CE(sat)}$  with positive temperature coefficient
- High short circuit capability, self limiting to  $6 \times I_C$

### Typical Applications\*

- AC inverter drives
- mains 575 - 750 V AC
- Public transport (auxiliary syst.)
- Wind power

$Z_{th}$		Values	Units
Symbol	Conditions		
$Z_{th(j-c)I}$			
$R_i$	$i = 1$	52	mk/W
$R_i$	$i = 2$	18	mk/W
$R_i$	$i = 3$	4,6	mk/W
$R_i$	$i = 4$	0,4	mk/W
$\tau_{u_i}$	$i = 1$	0,0569	s
$\tau_{u_i}$	$i = 2$	0,0122	s
$\tau_{u_i}$	$i = 3$	0,002	s
$\tau_{u_i}$	$i = 4$	0,02	s
$Z_{th(j-c)D}$			
$R_i$	$i = 1$	85	mk/W
$R_i$	$i = 2$	28	mk/W
$R_i$	$i = 3$	10,5	mk/W
$R_i$	$i = 4$	1,5	mk/W
$\tau_{u_i}$	$i = 1$	0,054	s
$\tau_{u_i}$	$i = 2$	0,0075	s
$\tau_{u_i}$	$i = 3$	0,0018	s
$\tau_{u_i}$	$i = 4$	0,0002	s

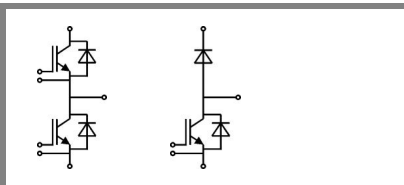

**GB**

**GAL**

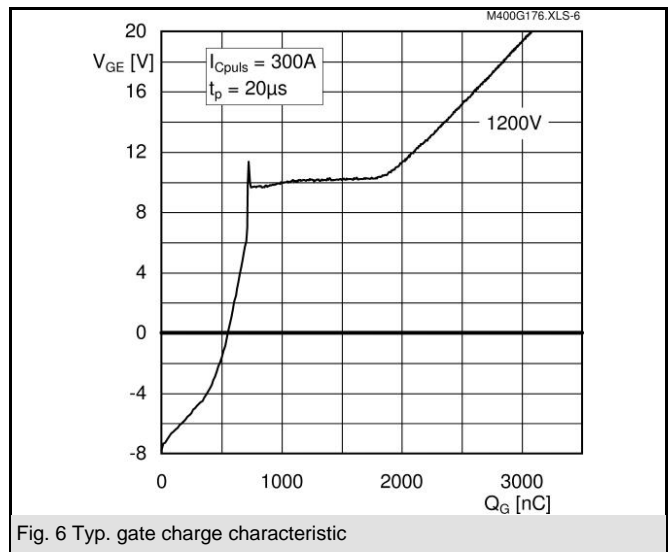
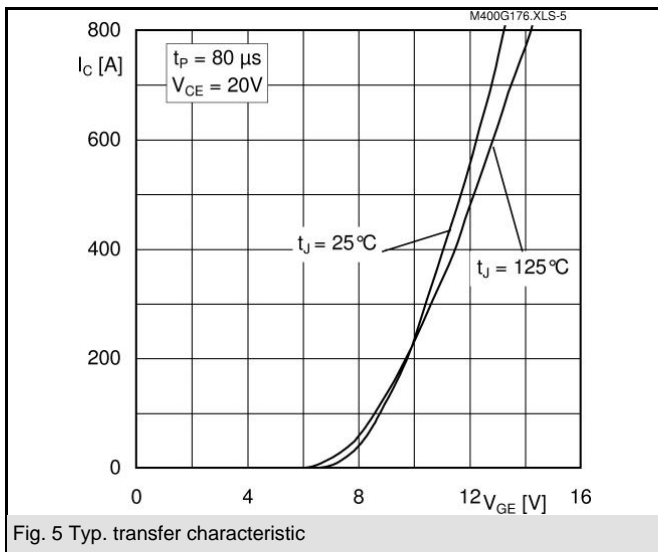
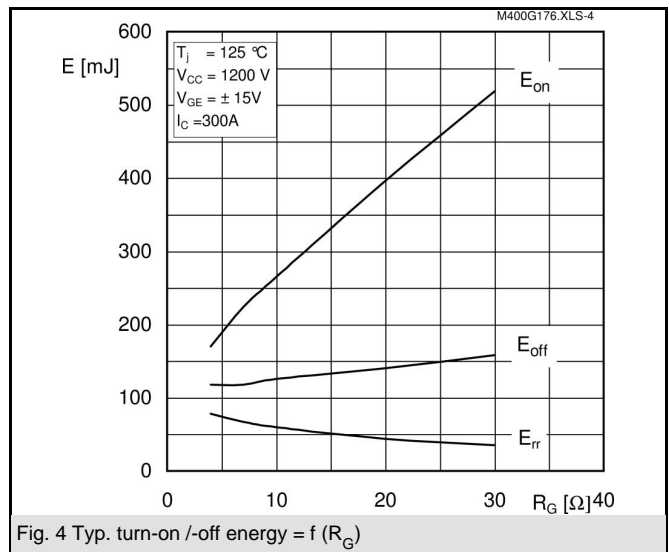
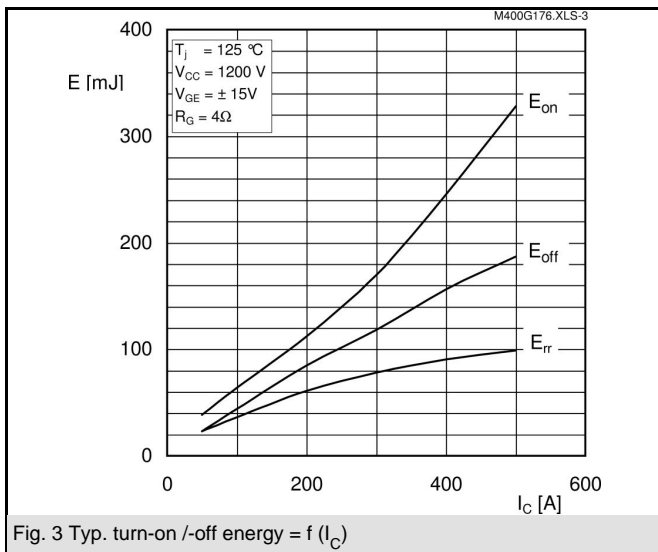
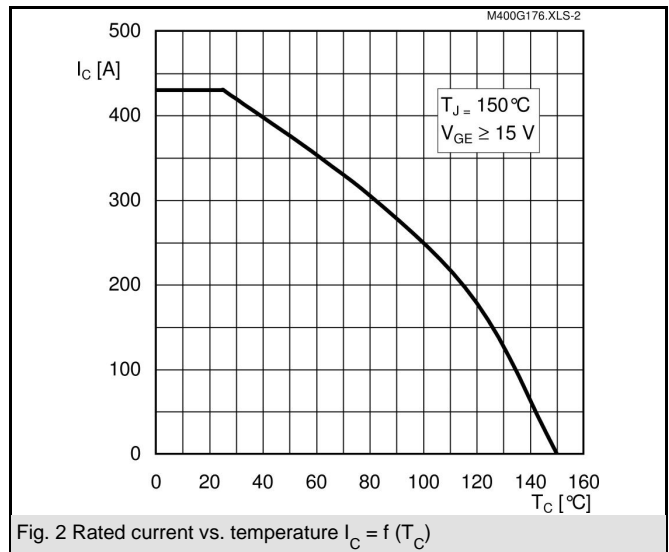
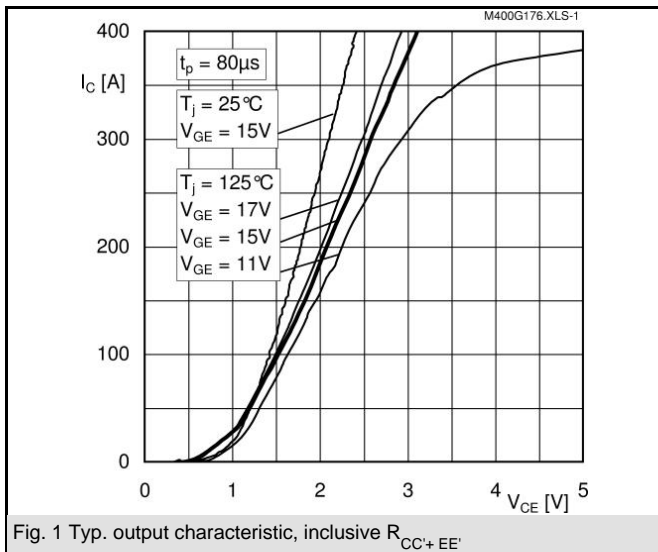

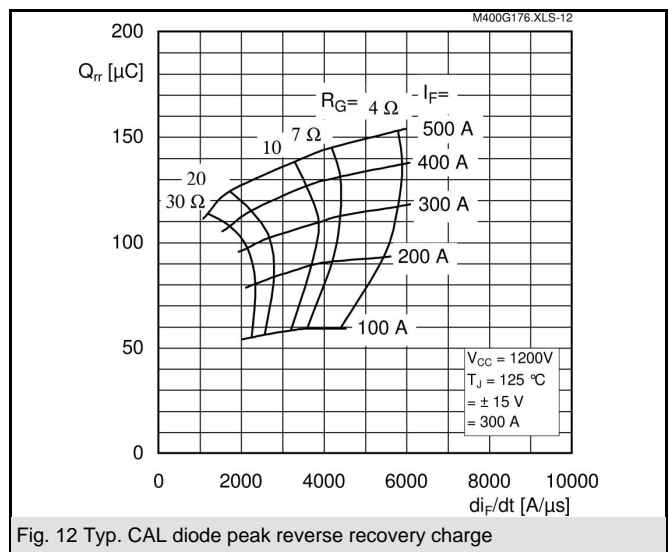
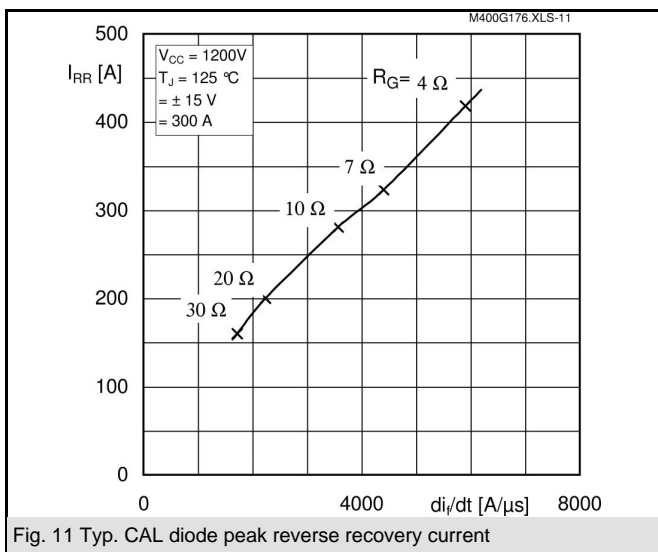
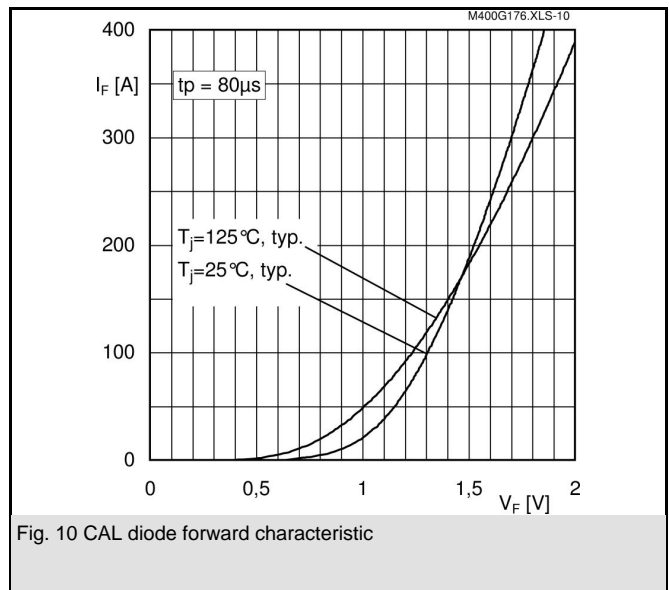
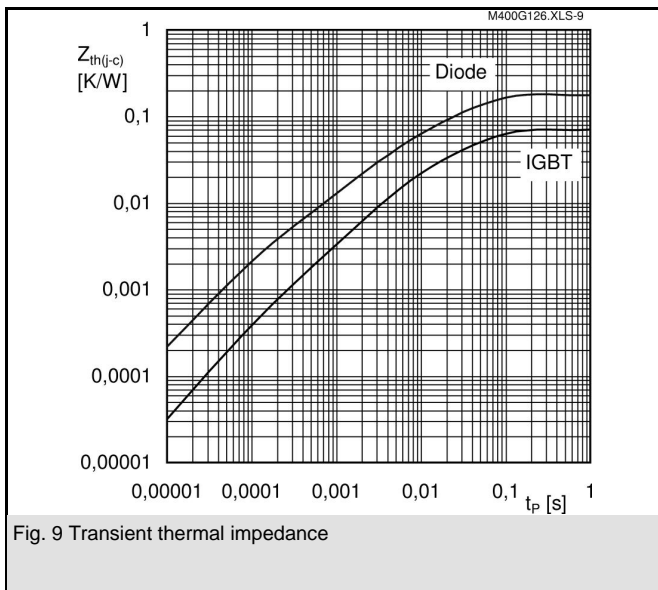
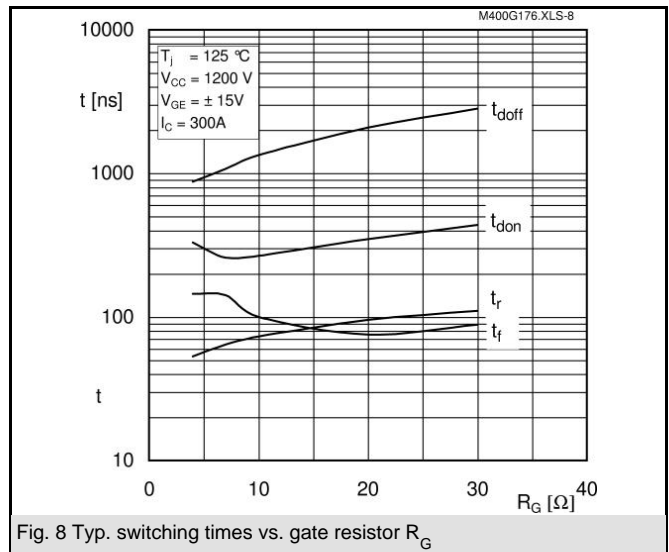
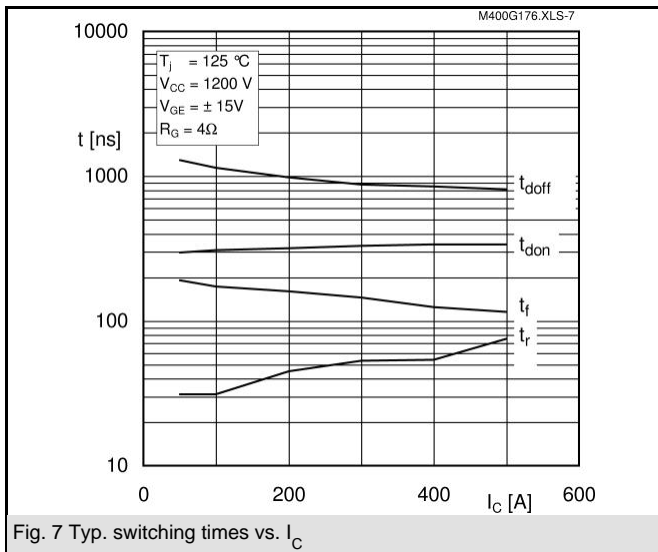

# SKM 400GB176D

UL Recognized

CASED56

File no. 63 532

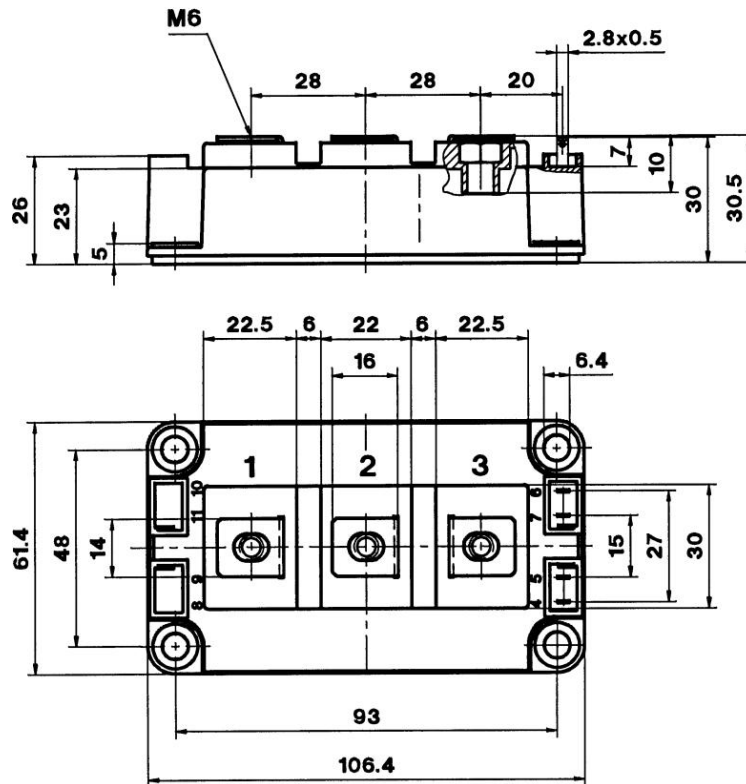

Case D 56

