

# SKM 100GB063D



SEMITRANS® 2

## Superfast NPT-IGBT Module

SKM 100GB063D

### Features

- N channel, homogeneous Silicon structure (NPT- Non punch through IGBT)
- Low tail current with low temperature dependence
- High short circuit capability, self limiting if term. G is clamped to E
- Pos. temp.-coeff. of  $V_{CEsat}$
- Very low  $C_{ies}$ ,  $C_{oes}$ ,  $C_{res}$
- Latch-up free
- Fast & soft inverse CAL diodes
- Isolated copper Bonding Technology without hard mould
- Large clearance (10 mm) and creepage distances (20 mm)

### Typical Applications\*

- Switching (not for linear use)
- Switched mode power supplies
- UPS
- Three phase inverters for servo / AC motor speed control
- Pulse frequencies also above 10 kHz

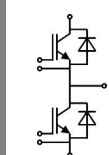

GB

Absolute Maximum Ratings		$T_c = 25^\circ\text{C}$ , unless otherwise specified		
Symbol	Conditions	Values		Units
<b>IGBT</b>				
$V_{CES}$	$T_j = 25^\circ\text{C}$	600		V
$I_C$	$T_j = 150^\circ\text{C}$	$T_{case} = 25^\circ\text{C}$	130	A
		$T_{case} = 70^\circ\text{C}$	100	A
$I_{CRM}$	$I_{CRM} = 2 \times I_{Cnom}$	200		A
$V_{GES}$		$\pm 20$		V
$t_{psc}$	$V_{CC} = 300\text{ V}; V_{GE} \leq 20\text{ V}; T_j = 125^\circ\text{C}$ $V_{CES} < 600\text{ V}$	10		$\mu\text{s}$
<b>Inverse Diode</b>				
$I_F$	$T_j = 150^\circ\text{C}$	$T_{case} = 25^\circ\text{C}$	100	A
		$T_{case} = 80^\circ\text{C}$	75	A
$I_{FRM}$	$I_{FRM} = 2 \times I_{Fnom}$	200		A
$I_{FSM}$	$t_p = 10\text{ ms}; \text{sin.}$	$T_j = 150^\circ\text{C}$	720	A
<b>Module</b>				
$I_{t(RMS)}$		200		A
$T_{vj}$		- 40 ... + 150		$^\circ\text{C}$
$T_{stg}$		- 40 ... + 125		$^\circ\text{C}$
$V_{isol}$	AC, 1 min.	2500		V

Characteristics		$T_c = 25^\circ\text{C}$ , unless otherwise specified			
Symbol	Conditions	min.	typ.	max.	Units
<b>IGBT</b>					
$V_{GE(th)}$	$V_{GE} = V_{CE}, I_C = 2\text{ mA}$	4,5	5,5	6,5	V
$I_{CES}$	$V_{GE} = 0\text{ V}, V_{CE} = V_{CES}$		0,1	0,3	mA
$V_{CE0}$		$T_j = 25^\circ\text{C}$	1,05		V
		$T_j = 125^\circ\text{C}$	1		V
$r_{CE}$	$V_{GE} = 15\text{ V}$	$T_j = 25^\circ\text{C}$	10,5		m $\Omega$
		$T_j = 125^\circ\text{C}$	14		m $\Omega$
$V_{CE(sat)}$	$I_{Cnom} = 100\text{ A}, V_{GE} = 15\text{ V}$	$T_j = 25^\circ\text{C}_{chiplev.}$	2,1	2,5	V
		$T_j = 125^\circ\text{C}_{chiplev.}$	2,4	2,8	V
$C_{ies}$	$V_{CE} = 25, V_{GE} = 0\text{ V}$	$f = 1\text{ MHz}$	5,6		nF
$C_{oes}$			0,6		nF
$C_{res}$			0,4		nF
$Q_G$	$V_{GE} = 0\text{ V} - +15\text{ V}$	240		nC	
$R_{Gint}$	$T_j = ^\circ\text{C}$	0		$\Omega$	
$t_{d(on)}$	$R_{Gon} = 10\ \Omega$	$V_{CC} = 300\text{ V}$ $I_C = 100\text{ A}$	50		ns
$t_r$			40		ns
$E_{on}$			4		mJ
$t_{d(off)}$	$R_{Goff} = 10\ \Omega$	$T_j = 125^\circ\text{C}$ $V_{GE} = \pm 15\text{ V}$	300		ns
$t_f$			35		ns
$E_{off}$			3		mJ
$R_{th(j-c)}$	per IGBT	0,27		K/W	

# SKM 100GB063D



SEMITRANS<sup>®</sup> 2

## Superfast NPT-IGBT Module

SKM 100GB063D

### Features

- N channel, homogeneous Silicon structure (NPT- Non punch through IGBT)
- Low tail current with low temperature dependence
- High short circuit capability, self limiting if term. G is clamped to E
- Pos. temp.-coeff. of  $V_{CEsat}$
- Very low  $C_{ies}$ ,  $C_{oes}$ ,  $C_{res}$
- Latch-up free
- Fast & soft inverse CAL diodes
- Isolated copper Bonding Technology without hard mould
- Large clearance (10 mm) and creepage distances (20 mm)

### Typical Applications\*

- Switching (not for linear use)
- Switched mode power supplies
- UPS
- Three phase inverters for servo / AC motor speed control
- Pulse frequencies also above 10 kHz



GB

Characteristics					
Symbol	Conditions	min.	typ.	max.	Units
<b>Inverse Diode</b>					
$V_F = V_{EC}$	$I_{Fnom} = 100 \text{ A}; V_{GE} = 0 \text{ V}$	$T_j = 25 \text{ }^\circ\text{C}_{chiplev.}$	1,55	1,9	V
		$T_j = 125 \text{ }^\circ\text{C}_{chiplev.}$	1,55		V
$V_{F0}$		$T_j = 125 \text{ }^\circ\text{C}$		0,9	V
$r_F$		$T_j = 125 \text{ }^\circ\text{C}$	8	10	m $\Omega$
$I_{RRM}$	$I_F = 100 \text{ A}$	$T_j = 125 \text{ }^\circ\text{C}$	44		A
$Q_{rr}$			6		$\mu\text{C}$
$E_{rr}$	$V_{GE} = -15 \text{ V}; V_{CC} = 300 \text{ V}$				mJ
$R_{th(j-c)D}$	per diode			0,6	K/W
<b>Module</b>					
$L_{CE}$				30	nH
$R_{CC+EE'}$	res., terminal-chip	$T_{case} = 25 \text{ }^\circ\text{C}$	0,75		m $\Omega$
		$T_{case} = 125 \text{ }^\circ\text{C}$	1		m $\Omega$
$R_{th(c-s)}$	per module			0,05	K/W
$M_s$	to heat sink M6		3	5	Nm
$M_t$	to terminals M5		2,5	5	Nm
w				160	g

This is an electrostatic discharge sensitive device (ESDS), international standard IEC 60747-1, Chapter IX.

\* The specifications of our components may not be considered as an assurance of component characteristics. Components have to be tested for the respective application. Adjustments may be necessary. The use of SEMIKRON products in life support appliances and systems is subject to prior specification and written approval by SEMIKRON. We therefore strongly recommend prior consultation of our personal.

# SKM 100GB063D

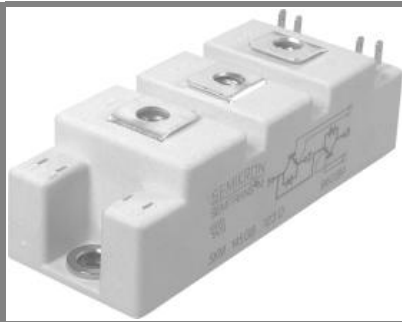

**SEMITRANS<sup>®</sup> 2**

## Superfast NPT-IGBT Module

**SKM 100GB063D**

### Features

- N channel, homogeneous Silicon structure (NPT- Non punch through IGBT)
- Low tail current with low temperature dependence
- High short circuit capability, self limiting if term. G is clamped to E
- Pos. temp.-coeff. of  $V_{CEsat}$
- Very low  $C_{ies}$ ,  $C_{oes}$ ,  $C_{res}$
- Latch-up free
- Fast & soft inverse CAL diodes
- Isolated copper Bonding Technology without hard mould
- Large clearance (10 mm) and creepage distances (20 mm)

### Typical Applications\*

- Switching (not for linear use)
- Switched mode power supplies
- UPS
- Three phase inverters for servo / AC motor speed control
- Pulse frequencies also above 10 kHz

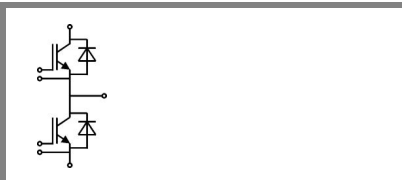

**GB**

$Z_{th}$		Values	Units
Symbol	Conditions		
$Z_{th(j-c)}$			
$R_i$	$i = 1$	160	mk/W
$R_i$	$i = 2$	88	mk/W
$R_i$	$i = 3$	18	mk/W
$R_i$	$i = 4$	4	mk/W
$\tau_{u_i}$	$i = 1$	0,0447	s
$\tau_{u_i}$	$i = 2$	0,0087	s
$\tau_{u_i}$	$i = 3$	0,0015	s
$\tau_{u_i}$	$i = 4$	0,0002	s
$Z_{th(j-c)D}$			
$R_i$	$i = 1$	400	mk/W
$R_i$	$i = 2$	165	mk/W
$R_i$	$i = 3$	30,5	mk/W
$R_i$	$i = 4$	4,5	mk/W
$\tau_{u_i}$	$i = 1$	0,0613	s
$\tau_{u_i}$	$i = 2$	0,0085	s
$\tau_{u_i}$	$i = 3$	0,0045	s
$\tau_{u_i}$	$i = 4$	0,0003	s

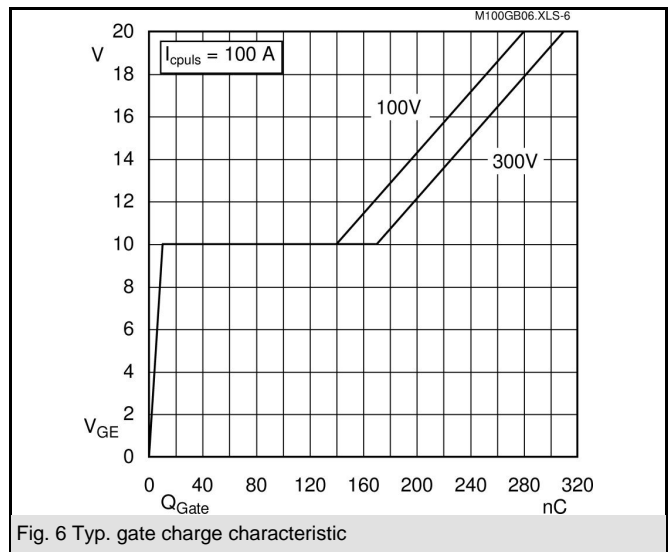
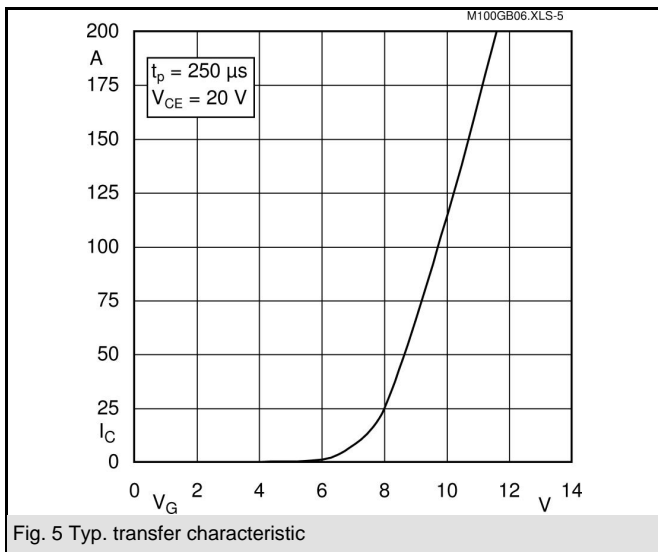
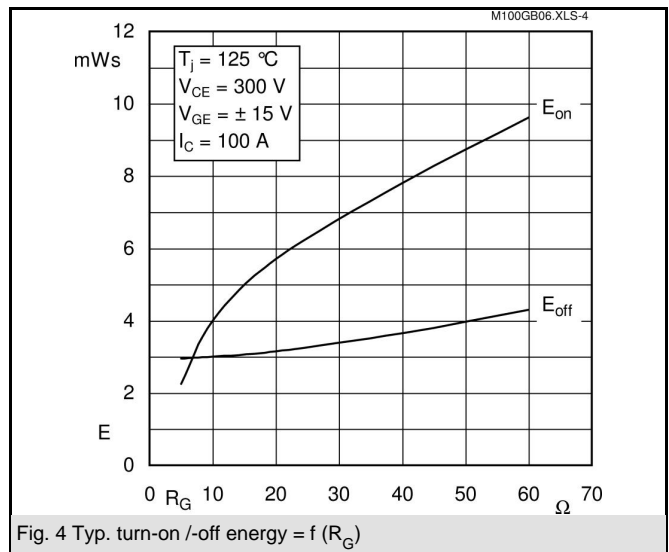
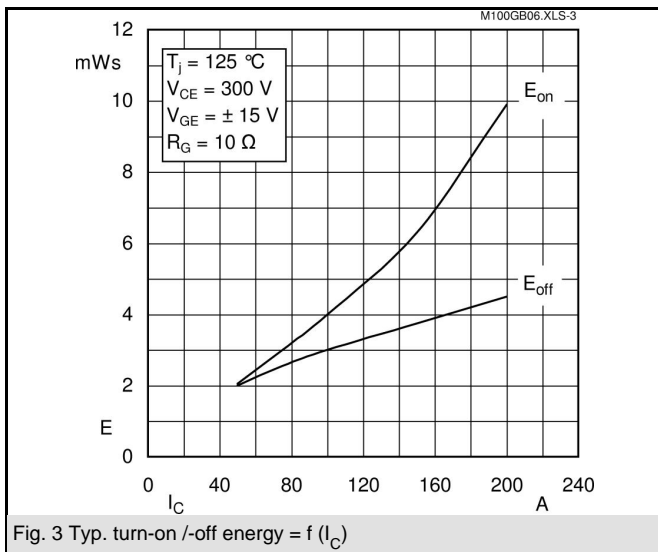
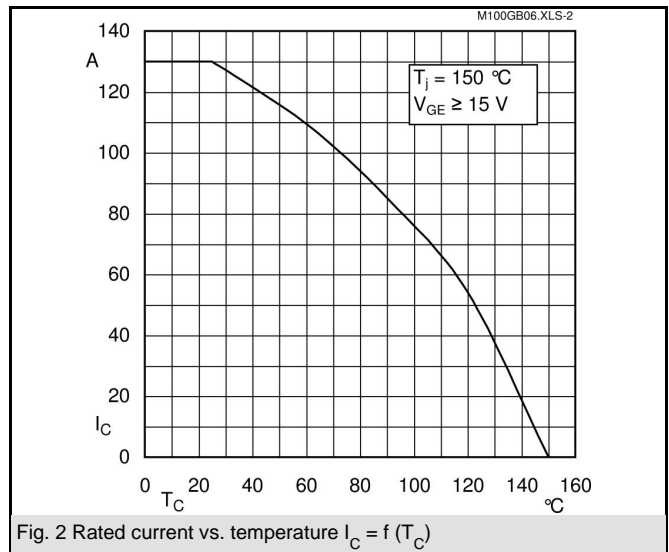
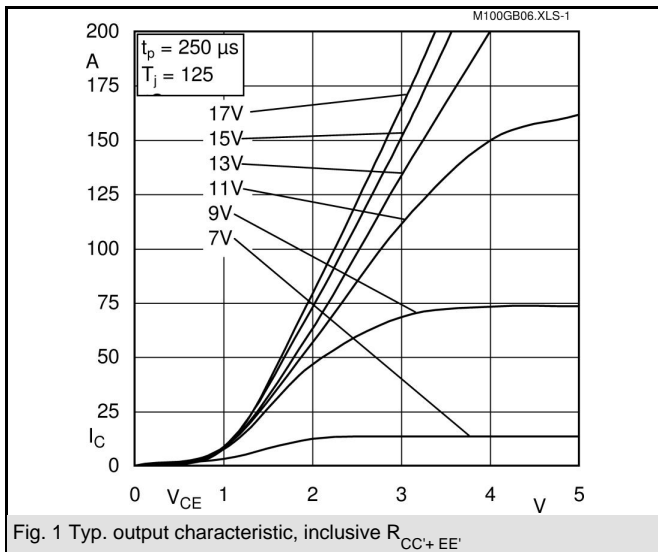

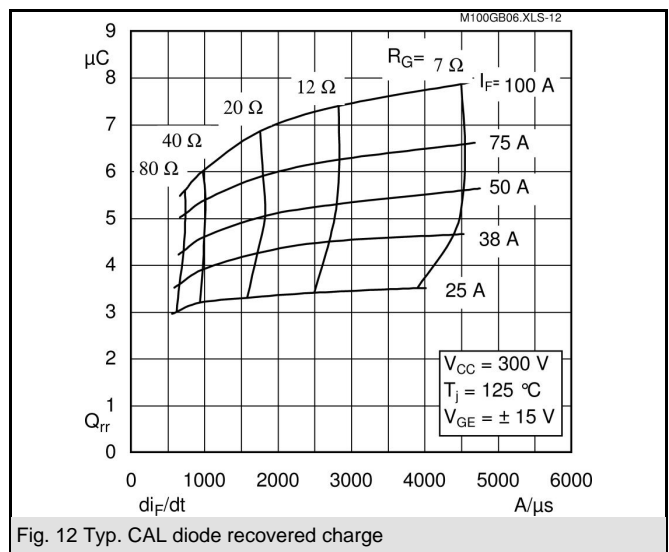
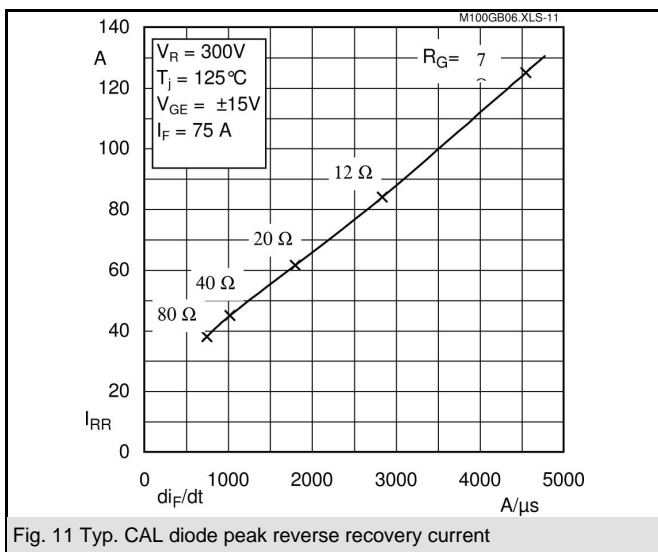
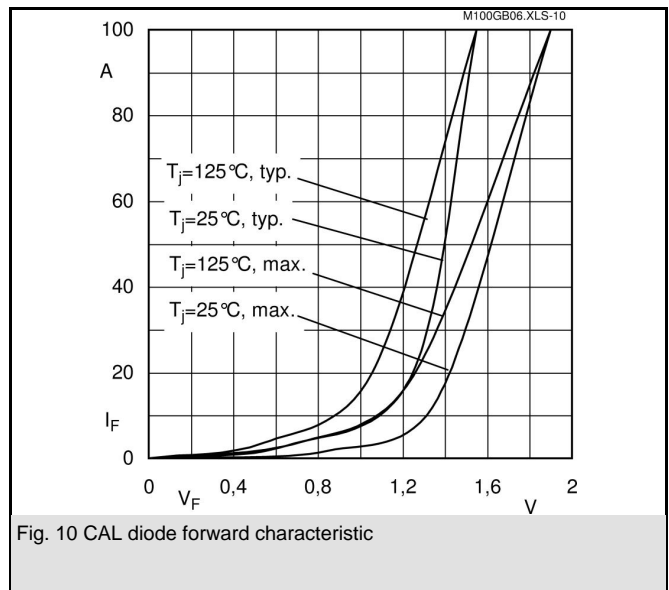
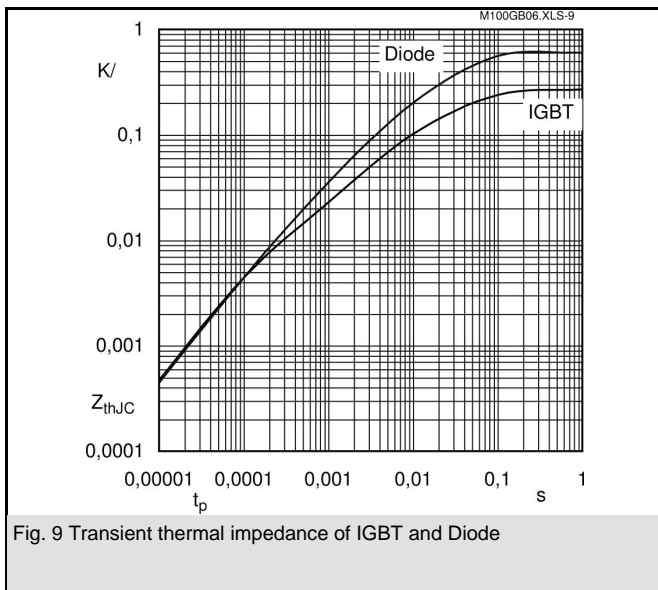
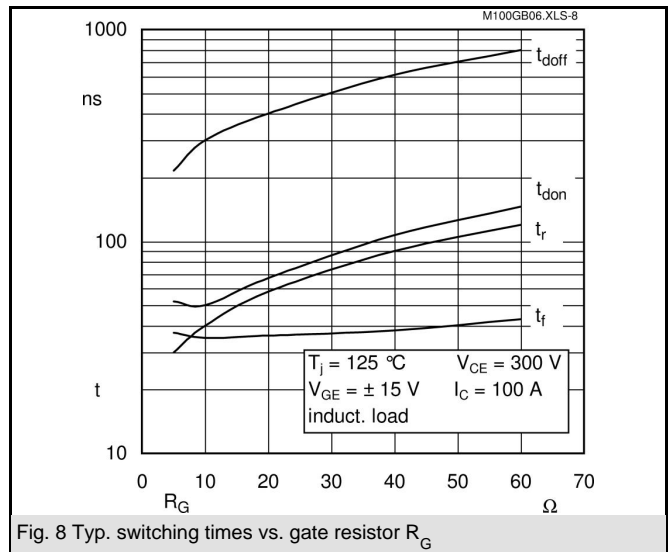
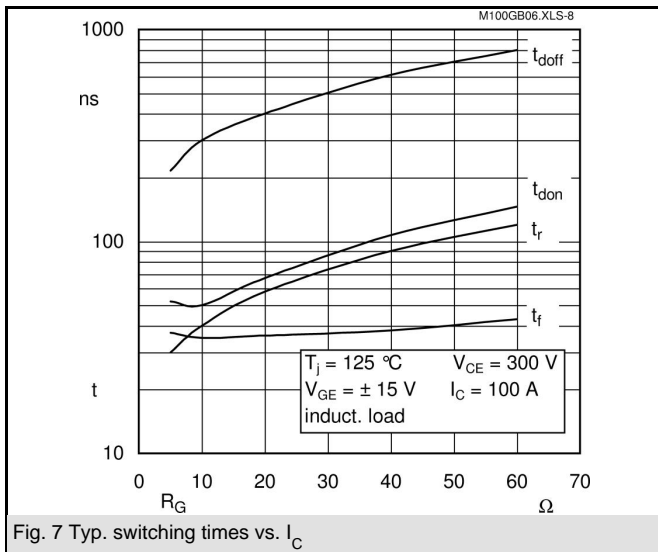

# SKM 100GB063D

UL recognized file

CASED61

no. E 63 532

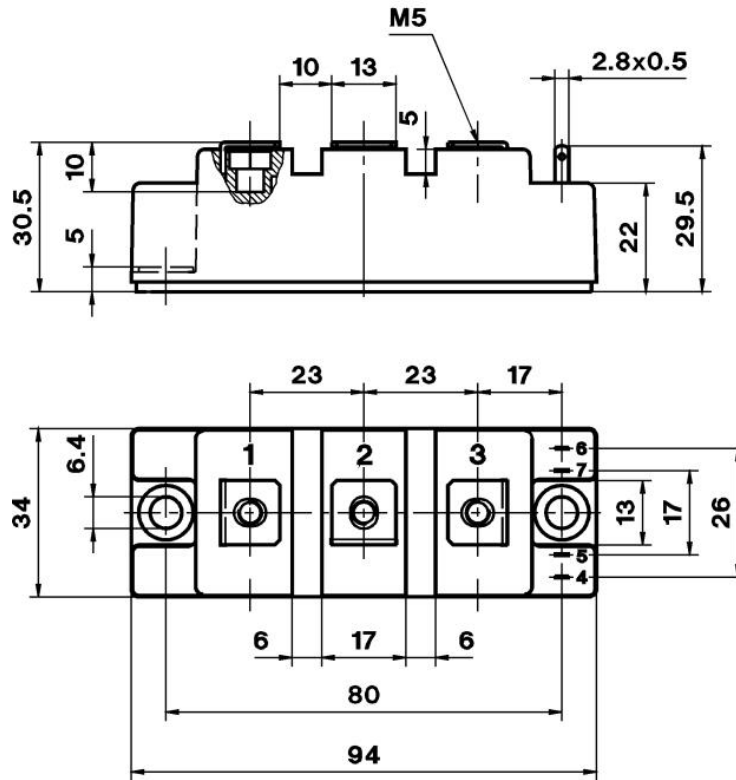

Case D 61

