

# SKM 195GB126D ...



**SEMITRANS® 2**

## Trench IGBT Modules

**SKM 195GB126D**

**SKM 195GAL126D**

### Features

- Trench = Trenchgate technology
- $V_{CE(sat)}$  with positive temperature coefficient
- High short circuit capability, self limiting to  $6 \times I_C$

### Typical Applications\*

- AC inverter drives
- UPS
- Electronic welders

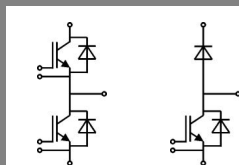

**GB**

**GAL**

Absolute Maximum Ratings		$T_{case} = 25^\circ\text{C}$ , unless otherwise specified		
Symbol	Conditions	Values		Units
<b>IGBT</b>				
$V_{CES}$	$T_j = 25^\circ\text{C}$	1200		V
$I_C$	$T_j = 150^\circ\text{C}$	$T_c = 25^\circ\text{C}$	220	A
		$T_c = 80^\circ\text{C}$	160	A
$I_{CRM}$	$I_{CRM} = 2 \times I_{Cnom}$	300		A
$V_{GES}$		$\pm 20$		V
$t_{psc}$	$V_{CC} = 600\text{ V}; V_{GE} \leq 20\text{ V}; T_j = 125^\circ\text{C}$ $V_{CES} < 1200\text{ V}$	10		$\mu\text{s}$
<b>Inverse Diode</b>				
$I_F$	$T_j = 150^\circ\text{C}$	$T_c = 25^\circ\text{C}$	170	A
		$T_c = 80^\circ\text{C}$	115	A
$I_{FRM}$	$I_{FRM} = 2 \times I_{Fnom}$	200		A
$I_{FSM}$	$t_p = 10\text{ ms}; \text{sin.}$	$T_j = 150^\circ\text{C}$	900	A
<b>Freewheeling Diode</b>				
$I_F$	$T_j = 150^\circ\text{C}$	$T_c = 25^\circ\text{C}$	170	A
		$T_c = 80^\circ\text{C}$	115	A
$I_{FRM}$	$I_{FRM} = 2 \times I_{Fnom}$	200		A
$I_{FSM}$	$t_p = 10\text{ ms}; \text{sin.}$	$T_j = 150^\circ\text{C}$	900	A
<b>Module</b>				
$I_{l(RMS)}$		200		A
$T_{vj}$		-40 ... +150		$^\circ\text{C}$
$T_{stg}$		-40 ... +125		$^\circ\text{C}$
$V_{isol}$	AC, 1 min.	4000		V

Characteristics		$T_{case} = 25^\circ\text{C}$ , unless otherwise specified			
Symbol	Conditions	min.	typ.	max.	Units
<b>IGBT</b>					
$V_{GE(th)}$	$V_{GE} = V_{CE}, I_C = 6\text{ mA}$	5	5,8	6,5	V
$I_{CES}$	$V_{GE} = 0\text{ V}, V_{CE} = V_{CES}$		0,1	0,3	mA
$V_{CE0}$		$T_j = 25^\circ\text{C}$	1	1,2	V
		$T_j = 125^\circ\text{C}$	0,9	1,1	V
$r_{CE}$	$V_{GE} = 0\text{ V}$	$T_j = 25^\circ\text{C}$	4,7	6,3	m $\Omega$
		$T_j = 125^\circ\text{C}$	7,3	9	m $\Omega$
$V_{CE(sat)}$	$I_{Cnom} = 150\text{ A}, V_{GE} = 15\text{ V}$	$T_j = 25^\circ\text{C}_{chiplev.}$	1,7	2,15	V
		$T_j = 125^\circ\text{C}_{chiplev.}$	2	2,45	V
$C_{res}$	$V_{CE} = 25\text{ V}, V_{GE} = 0\text{ V}$	$f = 1\text{ MHz}$	10,5		nF
$C_{oes}$			0,9		nF
$C_{res}$			0,8		nF
$Q_G$	$V_{GE} = -8\text{ V} \dots +20\text{ V}$	1380		nC	
$R_{Gint}$	$T_j = ^\circ\text{C}$	5		$\Omega$	
$t_{d(on)}$	$R_{Gon} = 2\ \Omega$	$V_{CC} = 600\text{ V}$ $I_C = 150\text{ A}$	280		ns
$t_r$			50		ns
$E_{on}$	$R_{Goff} = 2\ \Omega$	$T_j = 125^\circ\text{C}$ $V_{GE} = \pm 15\text{ V}$	16		mJ
$t_{d(off)}$			560		ns
$t_f$			70		ns
$E_{off}$			24,5		mJ
$R_{th(j-c)}$	per IGBT	0,16		K/W	



**SEMITRANS® 2**

## Trench IGBT Modules

**SKM 195GB126D**

**SKM 195GAL126D**

### Features

- Trench = Trenchgate technology
- $V_{CE(sat)}$  with positive temperature coefficient
- High short circuit capability, self limiting to  $6 \times I_C$

### Typical Applications\*

- AC inverter drives
- UPS
- Electronic welders

Characteristics					
Symbol	Conditions	min.	typ.	max.	Units
<b>Inverse Diode</b>					
$V_F = V_{EC}$	$I_{Fnom} = 100 \text{ A}; V_{GE} = 0 \text{ V}$	$T_j = 25 \text{ }^\circ\text{C}_{chiplev.}$	2	2,5	V
		$T_j = 125 \text{ }^\circ\text{C}_{chiplev.}$	1,8		V
$V_{F0}$		$T_j = 25 \text{ }^\circ\text{C}$	1,1	1,2	V
		$T_j = 125 \text{ }^\circ\text{C}$			V
$r_F$		$T_j = 25 \text{ }^\circ\text{C}$	9	13	mΩ
		$T_j = 125 \text{ }^\circ\text{C}$			mΩ
$I_{RRM}$	$I_F = 150 \text{ A}$	$T_j = 125 \text{ }^\circ\text{C}$	86		A
$Q_{rr}$	$di/dt = 2200 \text{ A}/\mu\text{s}$		17		μC
$E_{tr}$	$V_{GE} = -15 \text{ V}; V_{CC} = 600 \text{ V}$		5,8		mJ
$R_{th(j-c)D}$	per diode			0,32	K/W
<b>Freewheeling diode</b>					
$V_F = V_{EC}$	$I_{Fnom} = 100 \text{ A}; V_{GE} = 0 \text{ V}$	$T_j = 25 \text{ }^\circ\text{C}_{chiplev.}$	2	2,5	V
		$T_j = 125 \text{ }^\circ\text{C}_{chiplev.}$	1,8		V
$V_{F0}$		$T_j = 25 \text{ }^\circ\text{C}$	1,1	1,2	V
		$T_j = 125 \text{ }^\circ\text{C}$			V
$r_F$		$T_j = 25 \text{ }^\circ\text{C}$	9	13	V
		$T_j = 125 \text{ }^\circ\text{C}$			V
$I_{RRM}$	$I_F = 150 \text{ A}$	$T_j = 125 \text{ }^\circ\text{C}$	86		A
$Q_{rr}$	$di/dt = 2200 \text{ A}/\mu\text{s}$		17		μC
$E_{tr}$	$V_{GE} = -15 \text{ V}; V_{CC} = 600 \text{ V}$		5,8		mJ
$R_{th(j-c)FD}$	per diode			0,32	K/W
<b>Module</b>					
$L_{CE}$				30	nH
$R_{CC'+EE'}$	res., terminal-chip	$T_{case} = 25 \text{ }^\circ\text{C}$	0,75		mΩ
		$T_{case} = 125 \text{ }^\circ\text{C}$	1		mΩ
$R_{th(c-s)}$	per module			0,05	K/W
$M_s$	to heat sink M6		3	5	Nm
$M_t$	to terminals M5		2,5	5	Nm
w				160	g

This is an electrostatic discharge sensitive device (ESDS), international standard IEC 60747-1, Chapter IX.

\* The specifications of our components may not be considered as an assurance of component characteristics. Components have to be tested for the respective application. Adjustments may be necessary. The use of SEMIKRON products in life support appliances and systems is subject to prior specification and written approval by SEMIKRON. We therefore strongly recommend prior consultation of our personal.

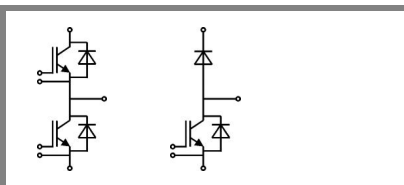

GB

GAL



**SEMITRANS<sup>®</sup> 2**

## Trench IGBT Modules

**SKM 195GB126D**

**SKM 195GAL126D**

### Features

- Trench = Trenchgate technology
- $V_{CE(sat)}$  with positive temperature coefficient
- High short circuit capability, self limiting to  $6 \times I_C$

### Typical Applications\*

- AC inverter drives
- UPS
- Electronic welders

$Z_{th}$		Values	Units
Symbol	Conditions		
$Z_{th(j-c)I}$			
$R_{\theta j-c}$	$i = 1$	115	mk/W
$R_{\theta j-c}$	$i = 2$	34	mk/W
$R_{\theta j-c}$	$i = 3$	9	mk/W
$R_{\theta j-c}$	$i = 4$	2	mk/W
$\tau_{\theta j-c}$	$i = 1$	0,0493	s
$\tau_{\theta j-c}$	$i = 2$	0,0174	s
$\tau_{\theta j-c}$	$i = 3$	0,0012	s
$\tau_{\theta j-c}$	$i = 4$	0,0002	s
$Z_{th(j-c)D}$			
$R_{\theta j-c}$	$i = 1$	200	mk/W
$R_{\theta j-c}$	$i = 2$	90	mk/W
$R_{\theta j-c}$	$i = 3$	26	mk/W
$R_{\theta j-c}$	$i = 4$	4	mk/W
$\tau_{\theta j-c}$	$i = 1$	0,054	s
$\tau_{\theta j-c}$	$i = 2$	0,0089	s
$\tau_{\theta j-c}$	$i = 3$	0,001	s
$\tau_{\theta j-c}$	$i = 4$	0,08	s

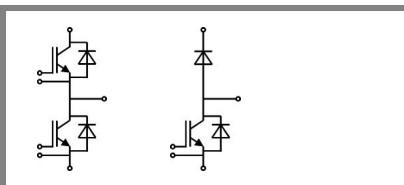

GB

GAL

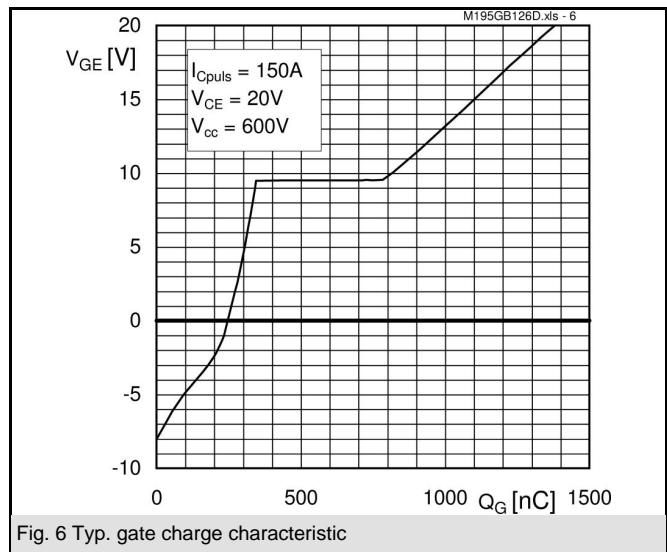
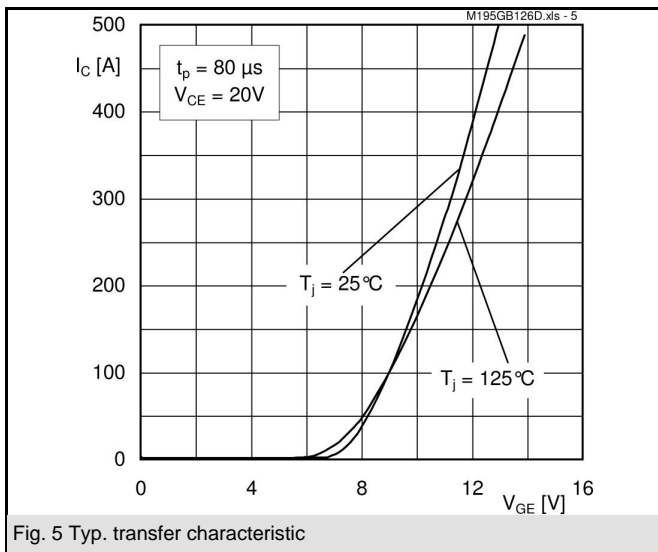
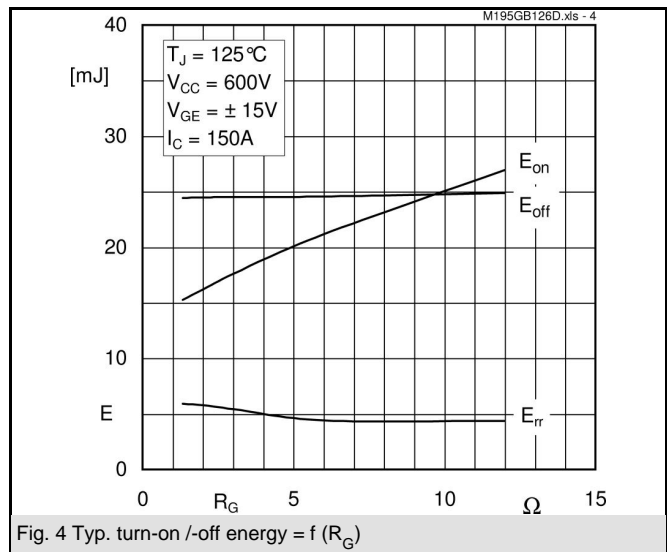
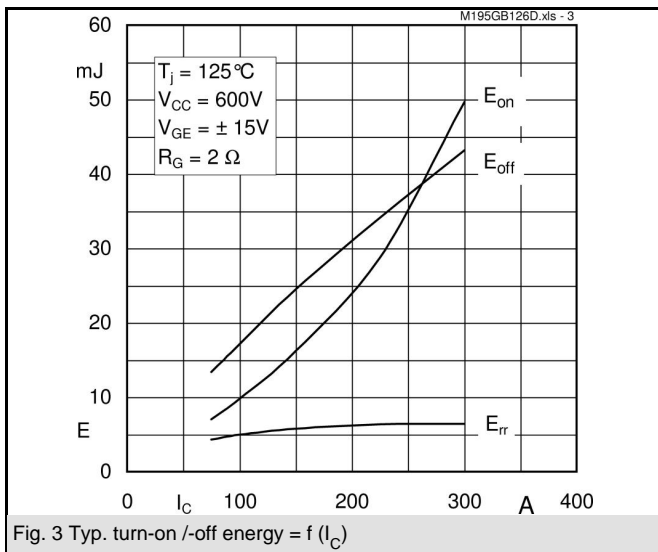
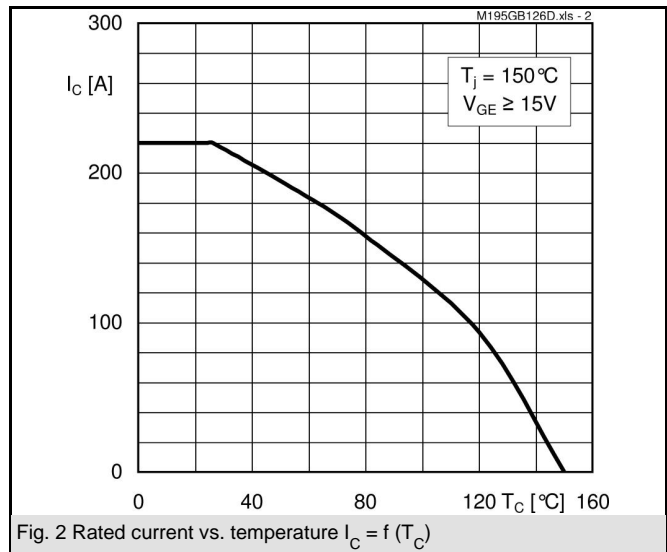
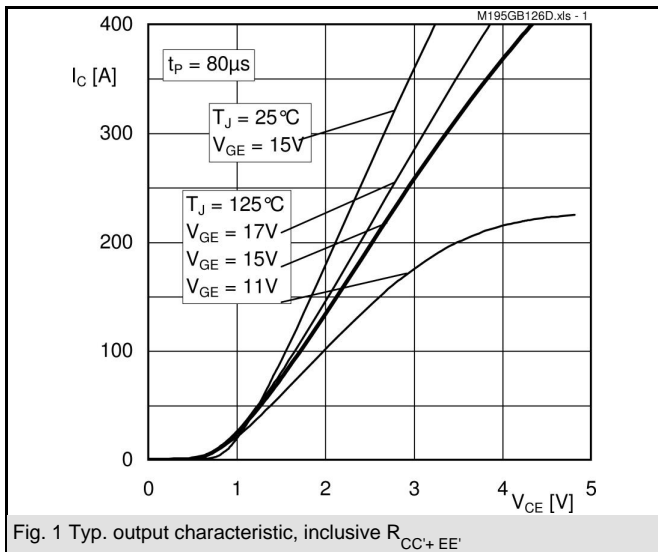

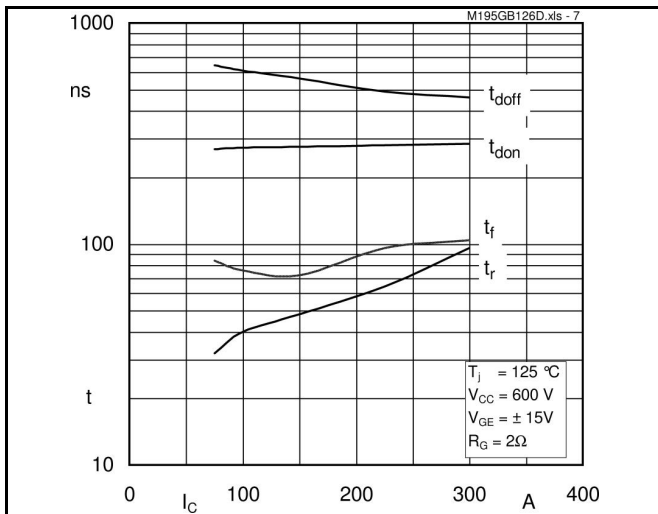

Fig. 7 Typ. switching times vs.  $I_C$

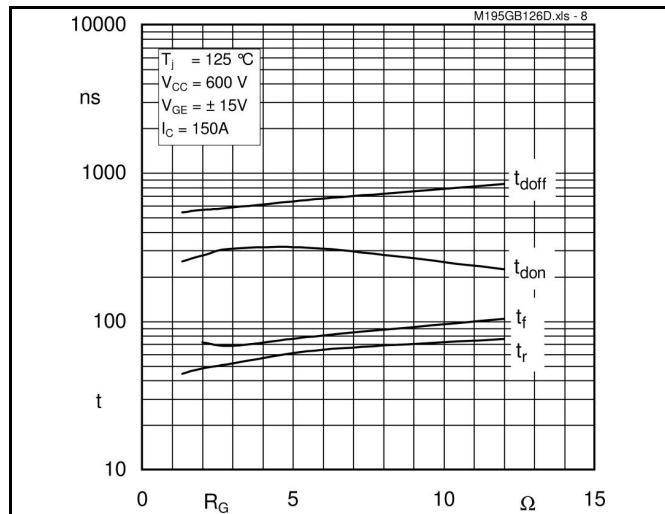

Fig. 8 Typ. switching times vs. gate resistor  $R_G$

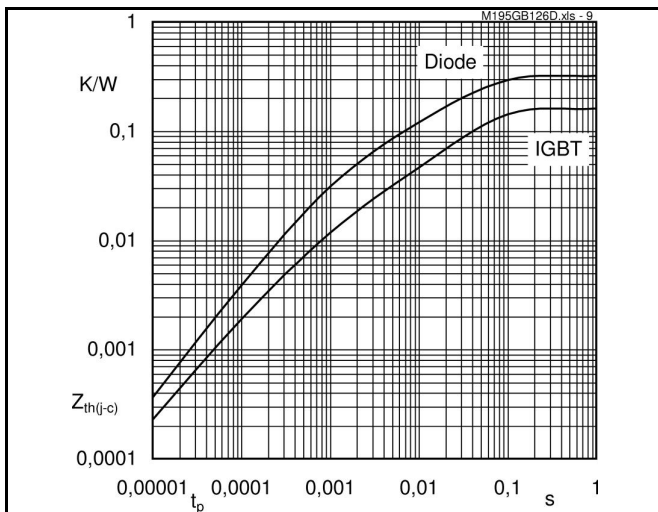

Fig. 9 Transient thermal impedance of IGBT

$$Z_{th(j-c)} = f(t_p); D = t/t_c = t * f$$

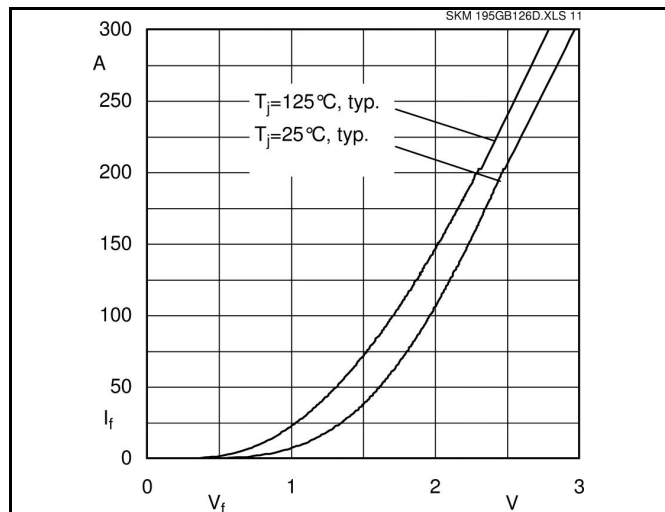

Fig. 10 Transient thermal impedance of FWD

$$Z_{th(j-c)} = f(t_p); D = t/t_c = t * f$$

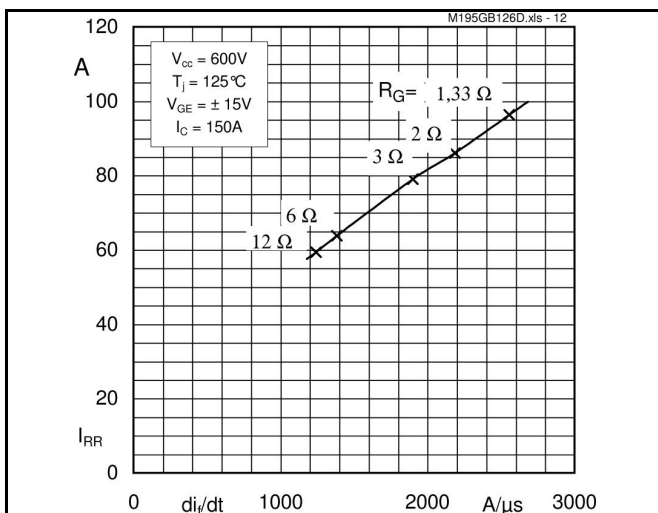

Fig. 11 CAL diode forward characteristic

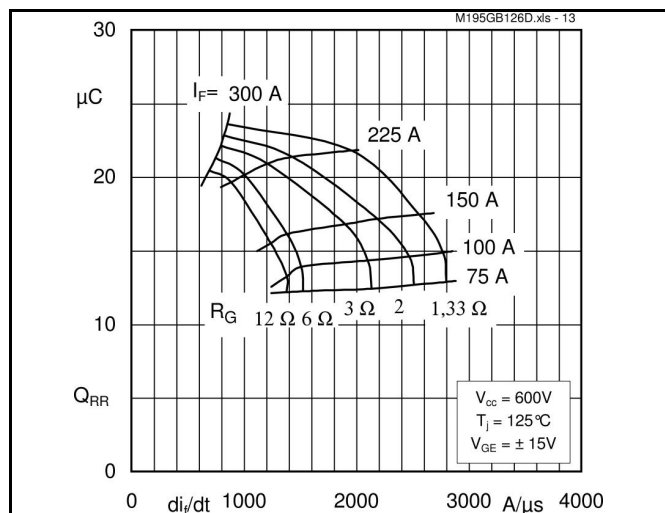

Fig. 12 Typ. CAL diode peak reverse recovery current

# SKM 195GB126D ...

UL Regognized

CASED61

File no. E 63 532

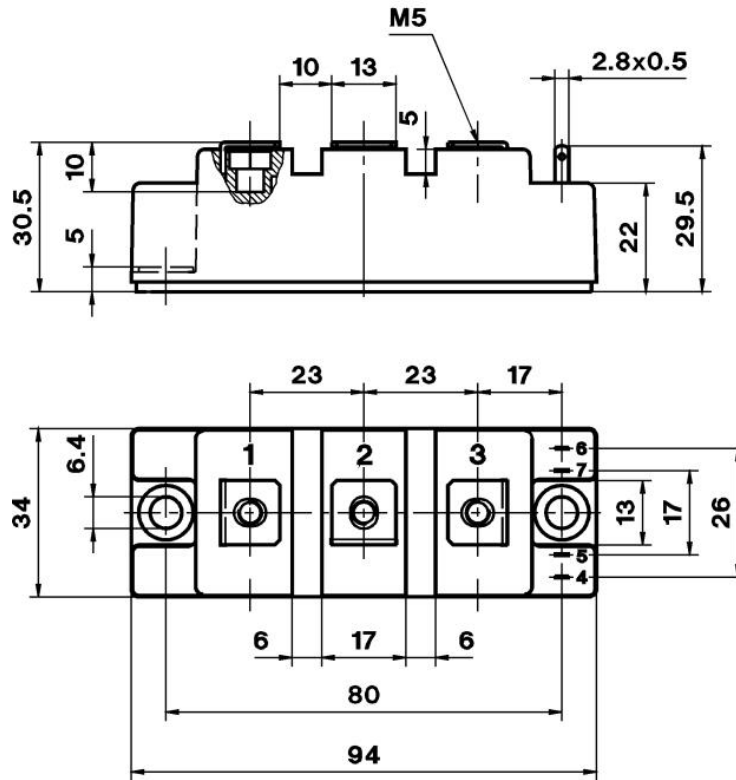

Case D 61

