

SKM 145GB176D



SEMITRANS[®] 2

Trench IGBT Modules

SKM 145GB176D

SKM 145GAL176D

Features

- Homogeneous Si
- Trench = Trenchgate technology
- $V_{CE(sat)}$ with positive temperature coefficient
- High short circuit capability, self limiting to $6 \times I_C$

Typical Applications*

- AC inverter drives mains 575 - 750 V AC
- Public transport (auxiliary systems)

Remarks

- Take care of over-voltage caused by stray inductances.
- Short circuit: Soft R_G necessary!

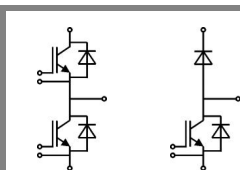

GB

GAL

Absolute Maximum Ratings		$T_{case} = 25^\circ\text{C}$, unless otherwise specified		
Symbol	Conditions	Values	Units	
IGBT				
V_{CES}	$T_j = 25^\circ\text{C}$	1700	V	
I_C	$T_j = 150^\circ\text{C}$	$T_{case} = 25^\circ\text{C}$	160	A
		$T_{case} = 80^\circ\text{C}$	120	A
I_{CRM}	$I_{CRM} = 2 \times I_{Cnom}$	200	A	
V_{GES}		± 20	V	
t_{psc}	$V_{CC} = 1200\text{ V}; V_{GE} \leq 20\text{ V}; T_j = 125^\circ\text{C}$ $V_{CES} < 1700\text{ V}$	10	μs	

Inverse Diode				
I_F	$T_j = 150^\circ\text{C}$	$T_{case} = 25^\circ\text{C}$	140	A
		$T_{case} = 80^\circ\text{C}$	100	A
I_{FRM}	$I_{FRM} = 2 \times I_{Fnom}$	200	A	
I_{FSM}	$t_p = 10\text{ ms}; \text{sin.}$	$T_j = 150^\circ\text{C}$	1400	A

Freewheeling Diode				
I_F	$T_j = 150^\circ\text{C}$	$T_{case} = 25^\circ\text{C}$	140	A
		$T_{case} = 80^\circ\text{C}$	100	A
I_{FRM}	$I_{FRM} = 2 \times I_{Fnom}$	200	A	
I_{FSM}	$t_p = 10\text{ ms}; \text{sin.}$	$T_j = 150^\circ\text{C}$	1400	A

Module			
$I_{l(RMS)}$		200	A
T_{vj}		- 40 ... +150	$^\circ\text{C}$
T_{stg}		- 40 ... +125	$^\circ\text{C}$
V_{isol}	AC, 1 min.	4000	V

Characteristics		$T_{case} = 25^\circ\text{C}$, unless otherwise specified			
Symbol	Conditions	min.	typ.	max.	Units
IGBT					
$V_{GE(th)}$	$V_{GE} = V_{CE}, I_C = 3,5\text{ mA}$	5,2	5,8	6,4	V
I_{CES}	$V_{GE} = 0\text{ V}, V_{CE} = V_{CES}$			3	mA
V_{CE0}		$T_j = 25^\circ\text{C}$	1	1,2	V
		$T_j = 125^\circ\text{C}$	0,9	1,1	V
r_{CE}	$V_{GE} = 15\text{ V}$	$T_j = 25^\circ\text{C}$	10	12,5	$\text{m}\Omega$
		$T_j = 125^\circ\text{C}$	15		$\text{m}\Omega$
$V_{CE(sat)}$	$I_{Cnom} = 100\text{ A}, V_{GE} = 15\text{ V}$	$T_j = 25^\circ\text{C}_{chiplev.}$	2	2,45	V
		$T_j = 125^\circ\text{C}_{chiplev.}$	2,4		V
C_{res}	$V_{CE} = 25, V_{GE} = 0\text{ V}$	$f = 1\text{ MHz}$	7,1		nF
C_{oes}			0,37		nF
C_{res}			0,29		nF
Q_G	$V_{GE} = -8\text{V} \dots +15\text{V}$		800		nC
$t_{d(on)}$	$R_{Gon} = 1\ \Omega$	$V_{CC} = 1200\text{V}$ $I_C = 100\text{A}$	250		ns
t_r			32		ns
E_{on}	$R_{Goff} = 1\ \Omega$	$T_j = 125^\circ\text{C}$ $V_{GE} = \pm 15\text{ V}$	60		mJ
$t_{d(off)}$			630		ns
t_f			145		ns
E_{off}			38		mJ
$R_{th(j-c)}$	per IGBT			0,19	K/W

SKM 145GB176D

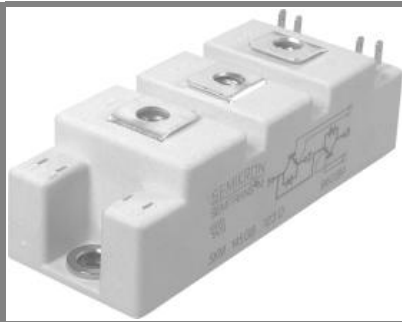

SEMITRANS® 2

Trench IGBT Modules

SKM 145GB176D

SKM 145GAL176D

Features

- Homogeneous Si
- Trench = Trenchgate technology
- $V_{CE(sat)}$ with positive temperature coefficient
- High short circuit capability, self limiting to $6 \times I_C$

Typical Applications*

- AC inverter drives mains 575 - 750 V AC
- Public transport (auxiliary systems)

Remarks

- Take care of over-voltage caused by stray inductances.
- Short circuit: Soft R_G necessary!

Characteristics					
Symbol	Conditions	min.	typ.	max.	Units
Inverse Diode					
$V_F = V_{EC}$	$I_{Fnom} = 100 \text{ A}; V_{GE} = 0 \text{ V}$	$T_j = 25 \text{ }^\circ\text{C}_{chiplev.}$	1,6	1,9	V
		$T_j = 125 \text{ }^\circ\text{C}_{chiplev.}$	1,6	1,9	V
V_{F0}		$T_j = 25 \text{ }^\circ\text{C}$	1,1	1,3	V
		$T_j = 125 \text{ }^\circ\text{C}$	0,9	1,1	V
r_F		$T_j = 25 \text{ }^\circ\text{C}$	5	6	m Ω
		$T_j = 125 \text{ }^\circ\text{C}$	7	8	m Ω
I_{RRM}	$I_F = 100 \text{ A}$	$T_j = 125 \text{ }^\circ\text{C}$	77		A
Q_{rr}	$di/dt = 2450 \text{ A}/\mu\text{s}$		39,5		μC
E_{tr}	$V_{GE} = -15 \text{ V}; V_{CC} = 1200 \text{ V}$		27,5		mJ
$R_{th(j-c)D}$	per diode			0,36	K/W
Freewheeling Diode					
$V_F = V_{EC}$	$I_{Fnom} = 100 \text{ A}; V_{GE} = 0 \text{ V}$	$T_j = 25 \text{ }^\circ\text{C}_{chiplev.}$	1,6	1,9	V
		$T_j = 125 \text{ }^\circ\text{C}_{chiplev.}$	1,6	1,9	V
V_{F0}		$T_j = 25 \text{ }^\circ\text{C}$	1,1	1,3	V
		$T_j = 125 \text{ }^\circ\text{C}$	0,9	1,1	V
r_F		$T_j = 25 \text{ }^\circ\text{C}$	5	6	V
		$T_j = 125 \text{ }^\circ\text{C}$	7	8	V
I_{RRM}	$I_F = 100 \text{ A}$	$T_j = 125 \text{ }^\circ\text{C}$	77		A
Q_{rr}	$di/dt = 2450 \text{ A}/\mu\text{s}$		39,5		μC
E_{tr}	$V_{GE} = -15 \text{ V}; V_{CC} = 1200 \text{ V}$		27,5		mJ
$R_{th(j-c)FD}$	per diode			0,36	K/W
Module					
L_{CE}				30	nH
$R_{CC'+EE'}$	res., terminal-chip	$T_{case} = 25 \text{ }^\circ\text{C}$	0,75		m Ω
		$T_{case} = 125 \text{ }^\circ\text{C}$	1		m Ω
$R_{th(c-s)}$	per module			0,05	K/W
M_s	to heat sink M6		3	5	Nm
M_t	to terminals M5		2,5	5	Nm
w				160	g

This is an electrostatic discharge sensitive device (ESDS), international standard IEC 60747-1, Chapter IX.

* The specifications of our components may not be considered as an assurance of component characteristics. Components have to be tested for the respective application. Adjustments may be necessary. The use of SEMIKRON products in life support appliances and systems is subject to prior specification and written approval by SEMIKRON. We therefore strongly recommend prior consultation of our personal.

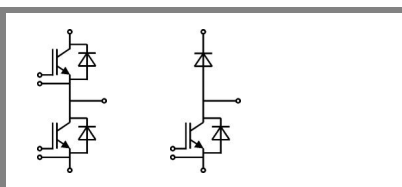

GB

GAL

SKM 145GB176D

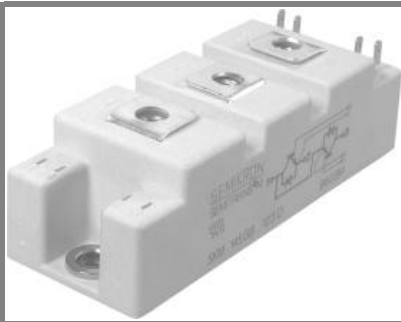

SEMITRANS[®] 2

Trench IGBT Modules

SKM 145GB176D

SKM 145GAL176D

Features

- Homogeneous Si
- Trench = Trenchgate technology
- $V_{CE(sat)}$ with positive temperature coefficient
- High short circuit capability, self limiting to $6 \times I_C$

Typical Applications*

- AC inverter drives mains 575 - 750 V AC
- Public transport (auxiliary systems)

Remarks

- Take care of over-voltage caused by stray inductances.
- Short circuit: Soft R_G necessary!

Z_{th}		Values	Units
Symbol	Conditions		
$Z_{th(j-c)}$			
$R_{\theta j-c}$	$i = 1$	115	mk/W
$R_{\theta j-c}$	$i = 2$	38,5	mk/W
$R_{\theta j-c}$	$i = 3$	5,7	mk/W
$R_{\theta j-c}$	$i = 4$	0,8	mk/W
$\tau_{\theta j-c}$	$i = 1$	0,0306	s
$\tau_{\theta j-c}$	$i = 2$	0,0852	s
$\tau_{\theta j-c}$	$i = 3$	0,004	s
$\tau_{\theta j-c}$	$i = 4$	0,0003	s
$Z_{th(j-c)D}$			
$R_{\theta j-cD}$	$i = 1$	190	mk/W
$R_{\theta j-cD}$	$i = 2$	80	mk/W
$R_{\theta j-cD}$	$i = 3$	25	mk/W
$R_{\theta j-cD}$	$i = 4$	5	mk/W
$\tau_{\theta j-cD}$	$i = 1$	0,0475	s
$\tau_{\theta j-cD}$	$i = 2$	0,0163	s
$\tau_{\theta j-cD}$	$i = 3$	0,0011	s
$\tau_{\theta j-cD}$	$i = 4$	0,0002	s

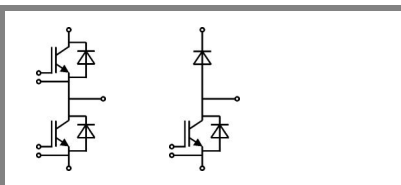

GB

GAL

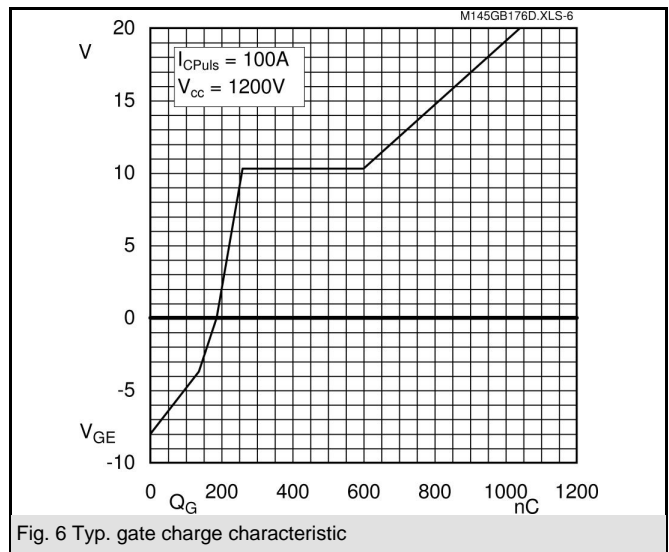
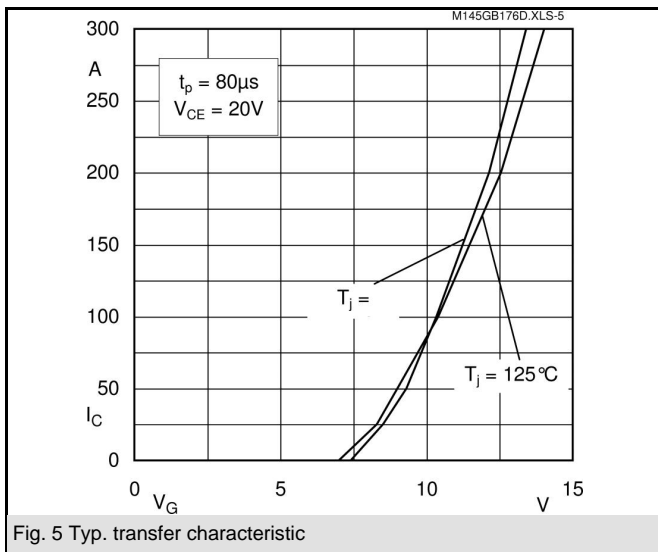
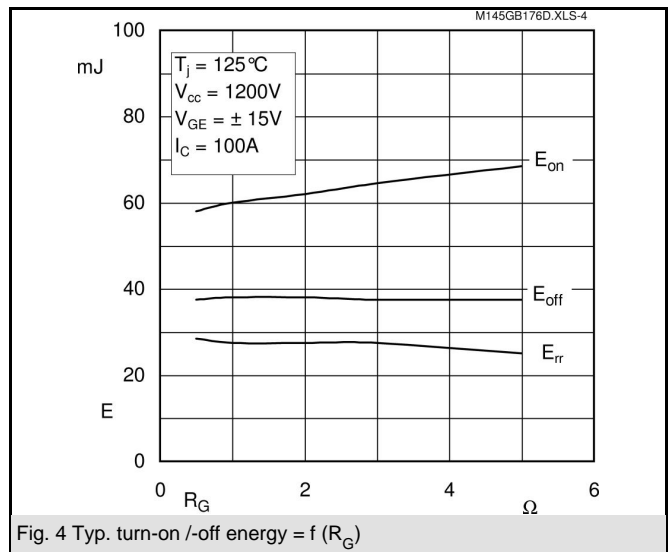
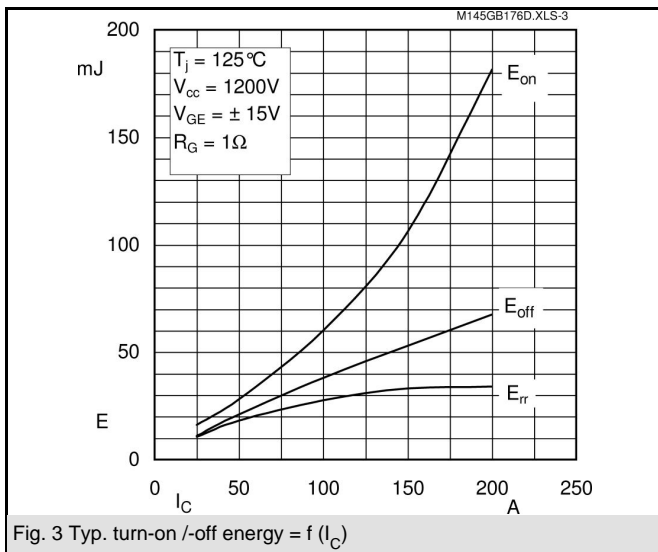
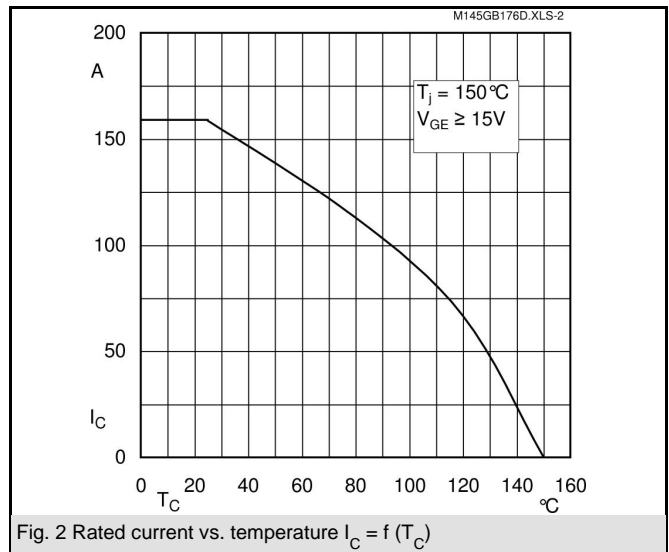
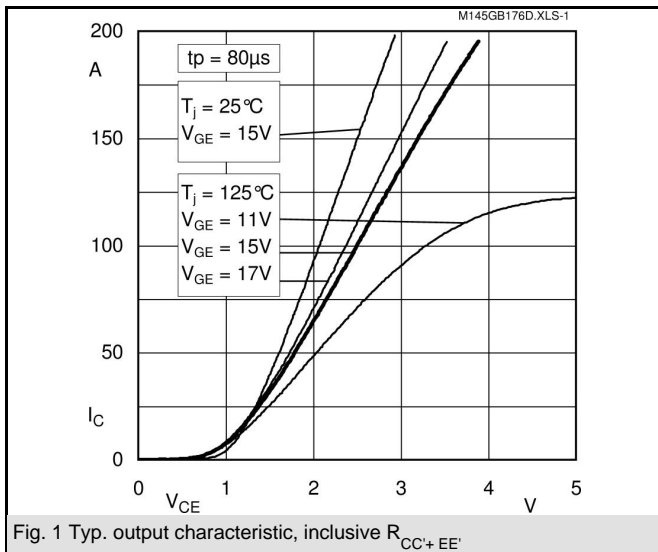

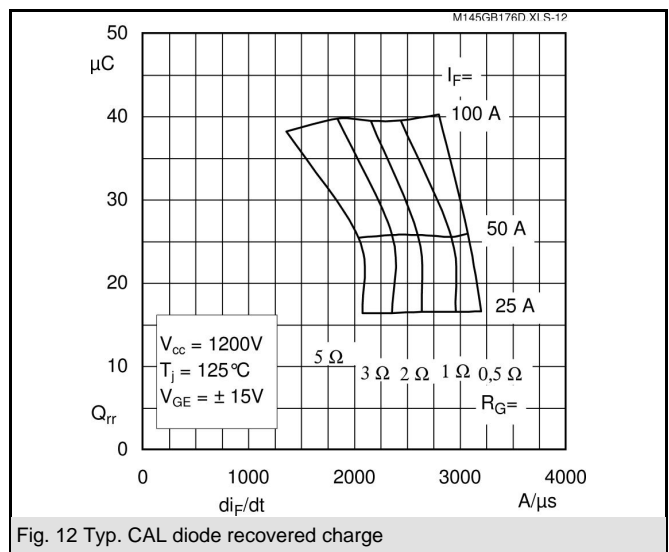
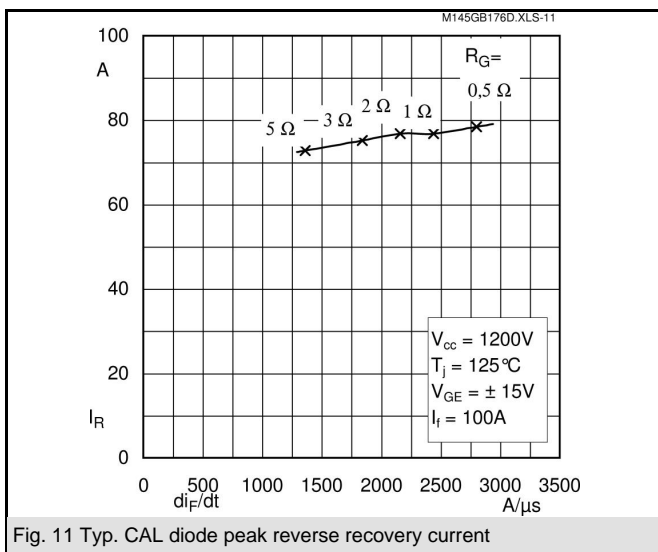
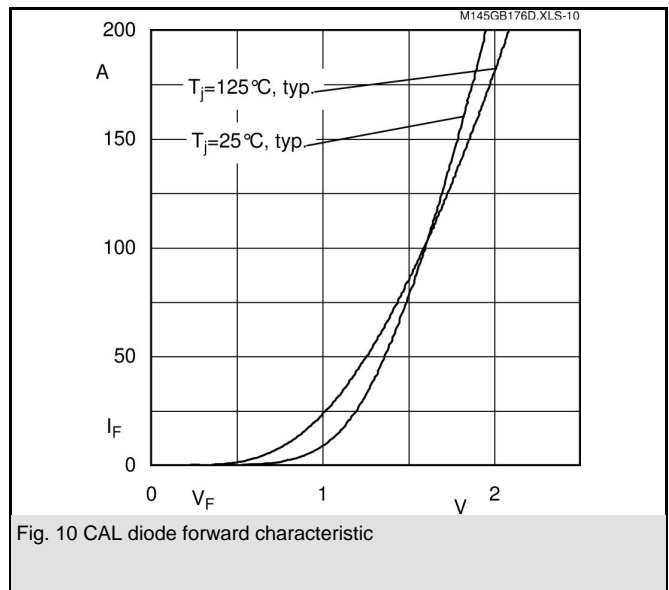
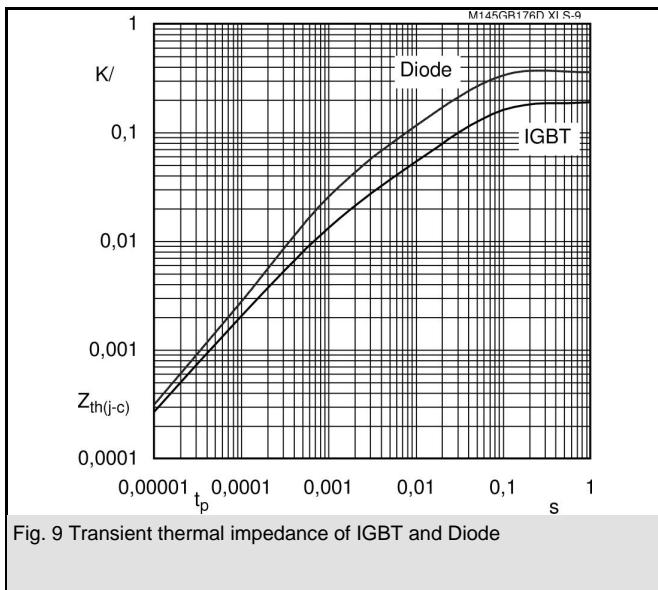
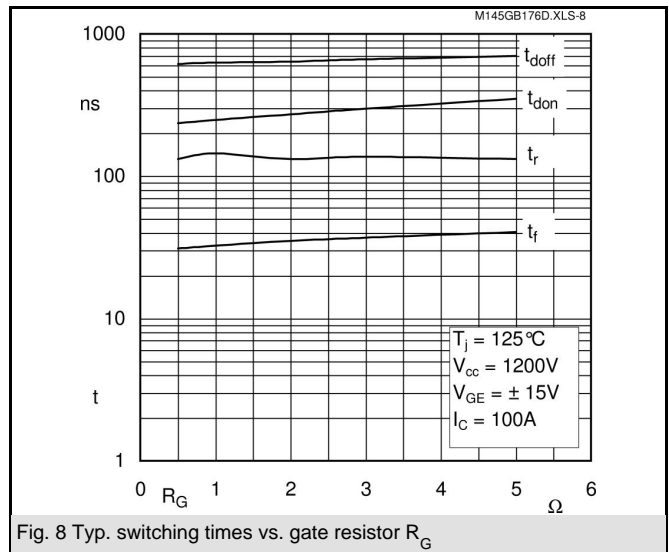
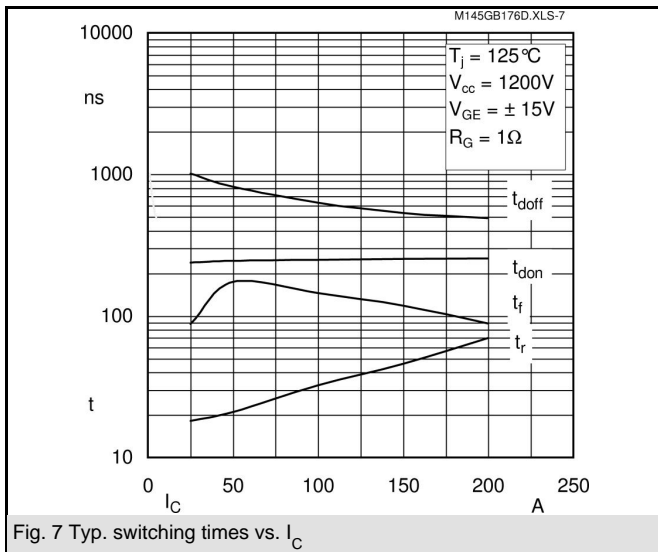

SKM 145GB176D

UL Recognized

CASED61

File no. E 63 532

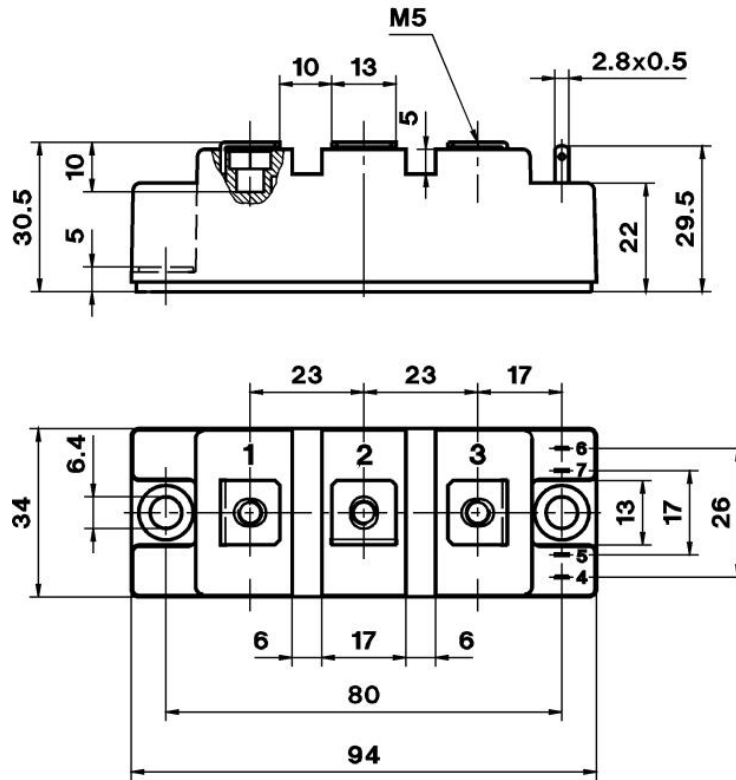

Case D 61

