

# SK50GH065F

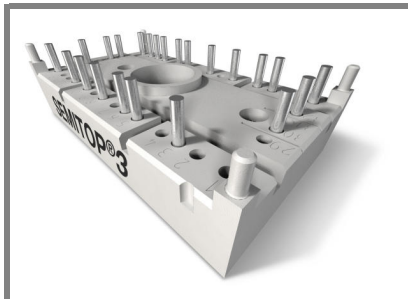

SEMITOP® 3

## IGBT Module

SK50GH065F

### Target Data

### Features

- Compact design
- One screw mounting
- Heat transfer and isolation through direct copper bonding aluminium oxide ceramic (DBC)
- Ultrafast NPT IGBT
- Turbo FWDiodes
- Low threshold voltage
- Low tail current with low temperature dependence

### Typical Applications\*

- Switching (not for linear use)
- Inverter
- Switched mode power supplies
- UPS

### Remarks

- $V_F$  = chip level value

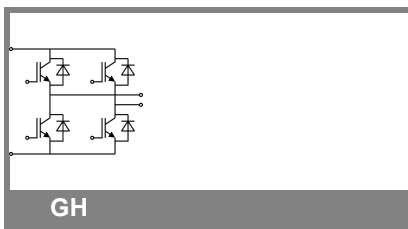

Absolute Maximum Ratings		$T_s = 25^\circ\text{C}$ , unless otherwise specified		
Symbol	Conditions	Values		Units
<b>IGBT</b>				
$V_{CES}$	$T_j = 25^\circ\text{C}$	600		V
$I_C$	$T_j = 125^\circ\text{C}$	$T_s = 25^\circ\text{C}$	54	A
		$T_s = 80^\circ\text{C}$	40	A
$I_{CRM}$	$I_{CRM} = 2 \times I_{Cnom}$	100		A
$V_{GES}$		$\pm 20$		V
$t_{psc}$	$V_{CC} = 300\text{ V}; V_{GE} \leq 20\text{ V}; T_j = 125^\circ\text{C}$ $V_{CES} < 600\text{ V}$	10		$\mu\text{s}$
<b>Inverse Diode</b>				
$I_F$	$T_j = 150^\circ\text{C}$	$T_s = 25^\circ\text{C}$	82	A
		$T_s = 80^\circ\text{C}$	50	A
$I_{FRM}$	$I_{FRM} = 2 \times I_{Fnom}$	120		A
<b>Module</b>				
$I_{t(RMS)}$				A
$T_{vj}$		-40 ... +150		$^\circ\text{C}$
$T_{stg}$		-40 ... +125		$^\circ\text{C}$
$V_{isol}$	AC, 1 min.	2500		V

Characteristics		$T_s = 25^\circ\text{C}$ , unless otherwise specified				
Symbol	Conditions	min.	typ.	max.	Units	
<b>IGBT</b>						
$V_{GE(th)}$	$V_{GE} = V_{CE}, I_C = 0,7\text{ mA}$	3	4	5	V	
$I_{CES}$	$V_{GE} = 600\text{ V}, V_{CE} = V_{CES}, T_j = 25^\circ\text{C}$			0,0022	mA	
$I_{GES}$	$V_{CE} = 0\text{ V}, V_{GE} = 20\text{ V}, T_j = 25^\circ\text{C}$			120	nA	
$V_{CE0}$		$T_j = 25^\circ\text{C}$	1,2	1,3	V	
		$T_j = 125^\circ\text{C}$	1,1	0,9	V	
$r_{CE}$	$V_{GE} = 15\text{ V}$	$T_j = 25^\circ\text{C}$			12	$\text{m}\Omega$
		$T_j = 125^\circ\text{C}$			22	$\text{m}\Omega$
$V_{CE(sat)}$	$I_{Cnom} = 60\text{ A}, V_{GE} = 15\text{ V}$	$T_j = 25^\circ\text{C}_{chiplev.}$	2	2,5	V	
		$T_j = 125^\circ\text{C}_{chiplev.}$	2,2	2,7	V	
$C_{res}$	$V_{CE} = 25, V_{GE} = 0\text{ V}, f = 1\text{ MHz}$			3,2	nF	
$C_{oes}$				0,3	nF	
$C_{res}$				0,18	nF	
$t_{d(on)}$	$R_{Gon} = 15\ \Omega$ $di/dt = 1200\text{ A}/\mu\text{s}$	$V_{CC} = 300\text{ V}$ $I_C = 60\text{ A}$			ns	
$t_r$					ns	
$E_{on}$			1,07		mJ	
$t_{d(off)}$	$R_{Goff} = 15\ \Omega$ $di/dt = 1200\text{ A}/\mu\text{s}$	$T_j = 125^\circ\text{C}$ $V_{GE} = \pm 15\text{ V}$			ns	
$t_f$					ns	
$E_{off}$			1,76		mJ	
$R_{th(j-s)}$	per IGBT			0,85	K/W	

# SK50GH065F

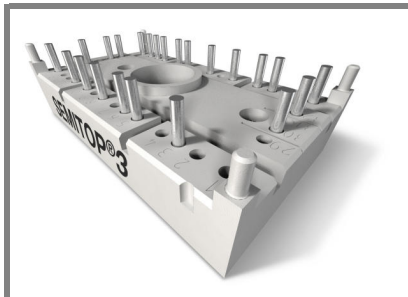

SEMITOP® 3

## IGBT Module

### SK50GH065F

#### Target Data

#### Features

- Compact design
- One screw mounting
- Heat transfer and isolation through direct copper bonding aluminium oxide ceramic (DBC)
- Ultrafast NPT IGBT
- Turbo FWDiodes
- Low threshold voltage
- Low tail current with low temperature dependence

#### Typical Applications\*

- Switching (not for linear use)
- Inverter
- Switched mode power supplies
- UPS

#### Remarks

- $V_F$  = chip level value

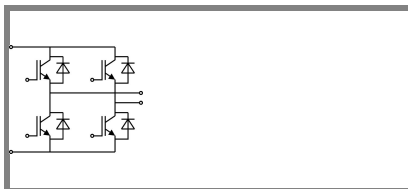

GH

#### Characteristics

Symbol	Conditions	min.	typ.	max.	Units	
<b>Inverse Diode</b>						
$V_F = V_{EC}$	$I_{Fnom} = 60 \text{ A}; V_{GE} = 0 \text{ V}$		$T_j = 25 \text{ }^\circ\text{C}_{\text{chiplev.}}$	1,1	1,6	V
			$T_j = 125 \text{ }^\circ\text{C}_{\text{chiplev.}}$		1,2	V
$V_{F0}$			$T_j = 150 \text{ }^\circ\text{C}$	0,85	V	
$r_F$			$T_j = 150 \text{ }^\circ\text{C}$	12	mΩ	
$I_{RRM}$	$I_F = 40 \text{ A}$		$T_j = 125 \text{ }^\circ\text{C}$	40	A	
$Q_{rr}$	$di/dt = 1200 \text{ A}/\mu\text{s}$			3	μC	
$E_{rr}$	$V_{CC} = 300 \text{ V}$			0,42	mJ	
$R_{th(j-s)D}$	per diode			1,1	K/W	
$M_s$	to heat sink	2,25		2,5	Nm	
w			30		g	

This is an electrostatic discharge sensitive device (ESDS), international standard IEC 60747-1, Chapter IX.

\* The specifications of our components may not be considered as an assurance of component characteristics. Components have to be tested for the respective application. Adjustments may be necessary. The use of SEMIKRON products in life support appliances and systems is subject to prior specification and written approval by SEMIKRON. We therefore strongly recommend prior consultation of our personal.

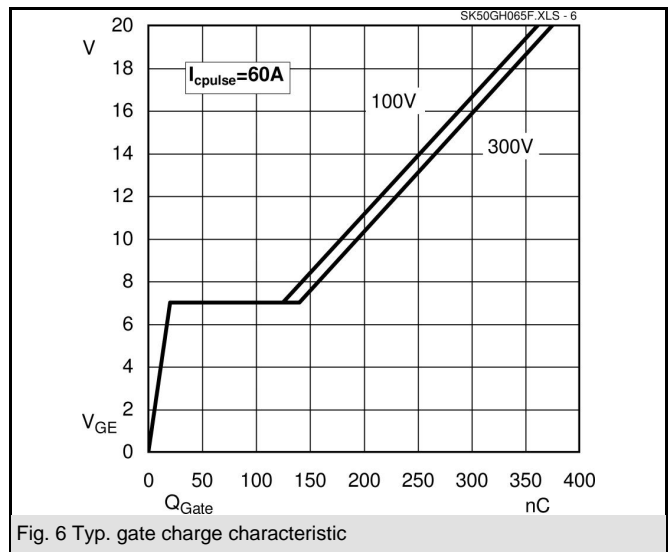
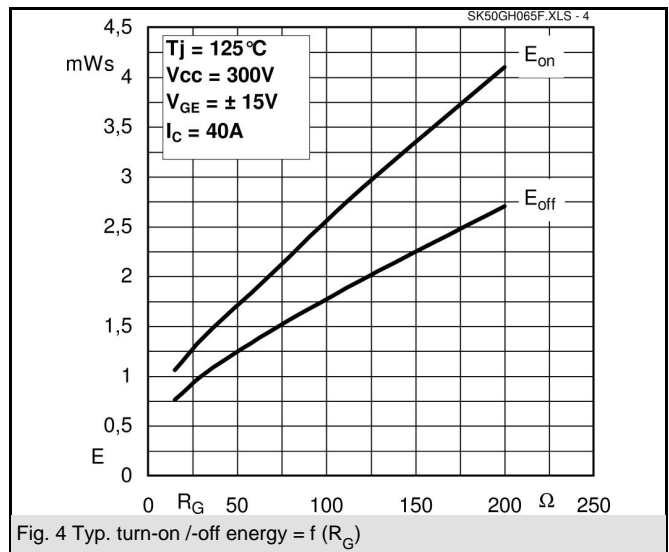
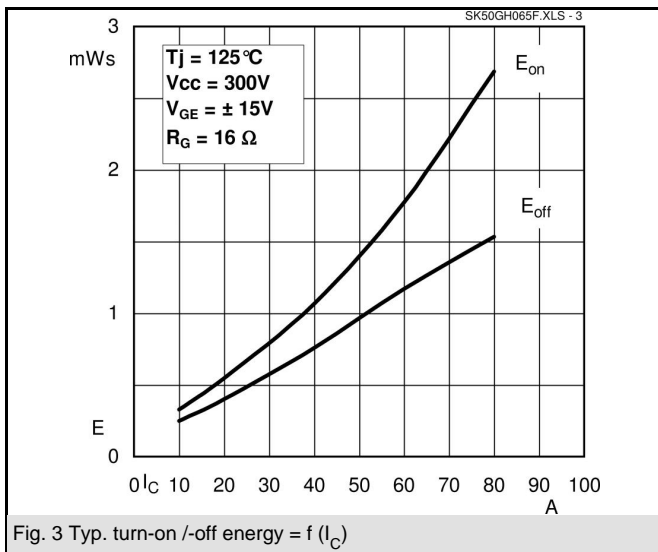
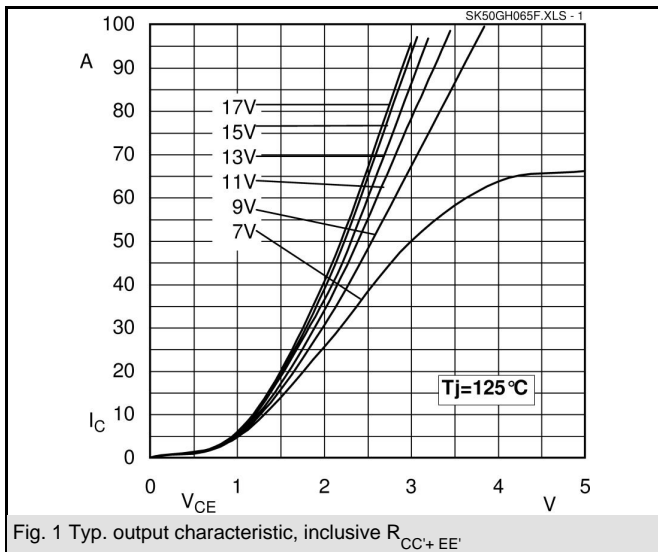

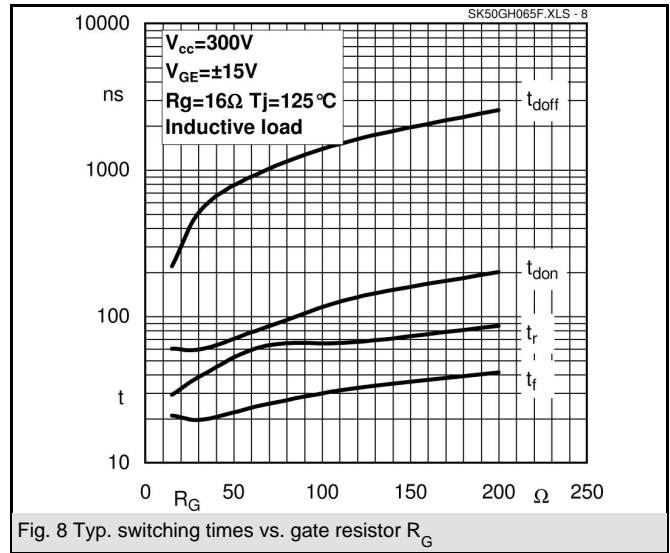
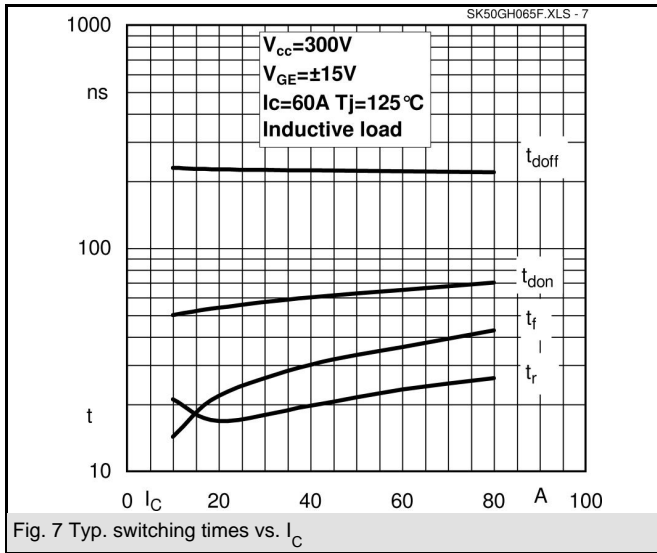

# SK50GH065F

UL recognized file

no. E 63 532

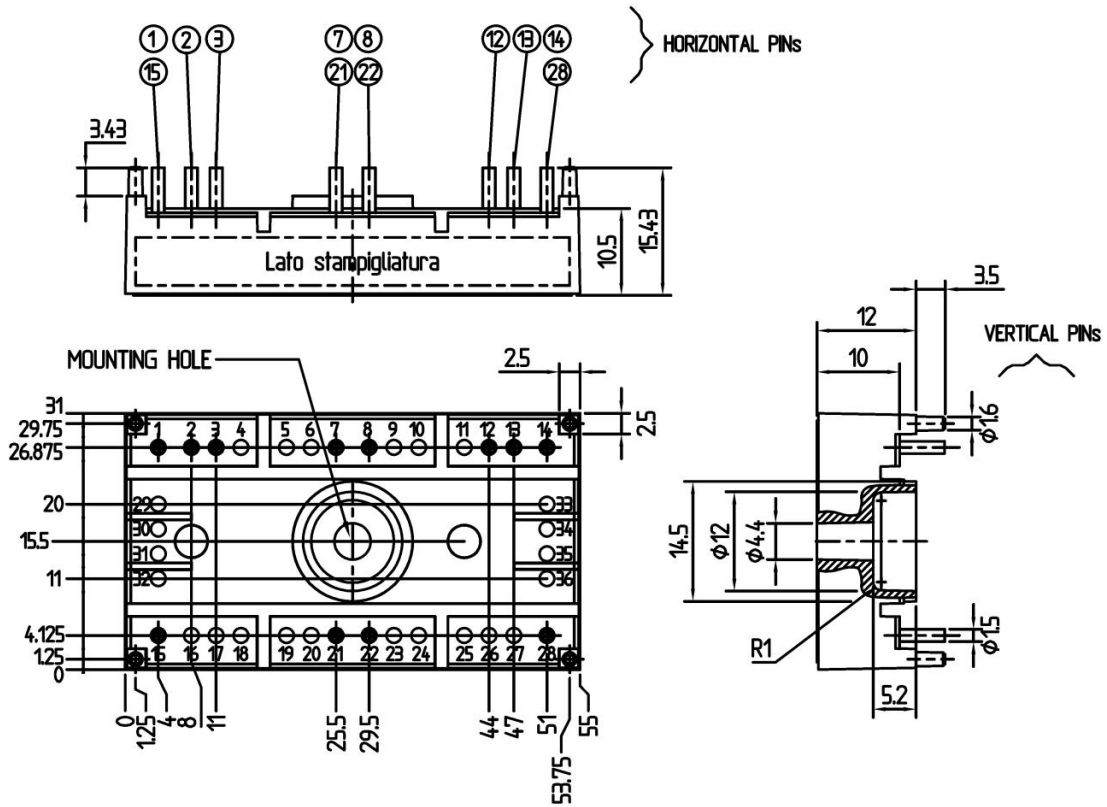

Case T19 (Suggested hole diameter, in the PCB, for solder pins and plastic mounting pins: 2mm)

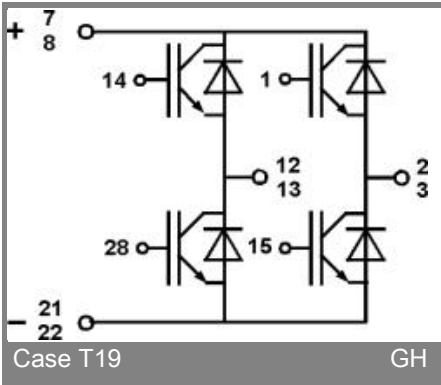

Case T19

GH