

SK35GD065ET

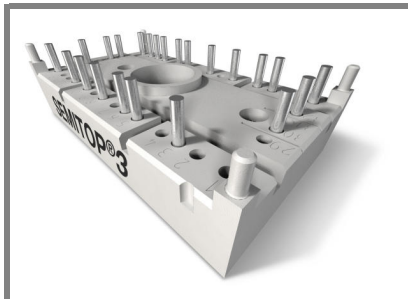

SEMITOP® 3

IGBT Module

SK35GD065ET

Preliminary Data

Features

- Compact design
- One screw mounting
- Heat transfer and isolation through direct copper bonded aluminium oxide ceramic (DCB)
- Ultrafast NPT technology IGBT
- CAL technology FWD
- Integrated NTC temperature sensor

Typical Applications*

- Inverter

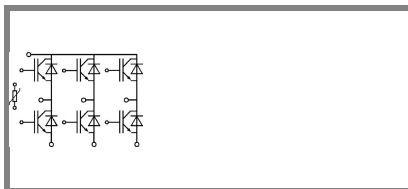

GD-ET

Absolute Maximum Ratings		$T_s = 25^\circ\text{C}$, unless otherwise specified			
Symbol	Conditions	Values			Units
IGBT					
V_{CES}	$T_j = 25^\circ\text{C}$	600			V
I_C	$T_j = 125^\circ\text{C}$	$T_s = 25^\circ\text{C}$	45		A
		$T_s = 80^\circ\text{C}$	33		A
I_{CRM}	$I_{CRM} = 2 \times I_{Cnom}$	100			A
V_{GES}		± 20			V
t_{psc}	$V_{CC} = 300\text{ V}; V_{GE} \leq 20\text{ V}; T_j = 125^\circ\text{C}$ $V_{CES} < 600\text{ V}$	10			μs
Inverse Diode					
I_F	$T_j = 150^\circ\text{C}$	$T_s = 25^\circ\text{C}$	36		A
		$T_s = 80^\circ\text{C}$	24		A
I_{FRM}	$I_{FRM} = 2 \times I_{Fnom}$	70			A
Module					
$I_{t(RMS)}$					A
T_{vj}		-40 ... +150			$^\circ\text{C}$
T_{stg}		-40 ... +125			$^\circ\text{C}$
V_{isol}	AC, 1 min.	2500			V

Characteristics		$T_s = 25^\circ\text{C}$, unless otherwise specified			
Symbol	Conditions	min.	typ.	max.	Units
IGBT					
$V_{GE(th)}$	$V_{GE} = V_{CE}; I_C = 1\text{ mA}$	3	4	5	V
I_{CES}	$V_{GE} = 0\text{ V}, V_{CE} = V_{CES}$	$T_j = 25^\circ\text{C}$			mA
		$T_j = 125^\circ\text{C}$			mA
I_{GES}	$V_{CE} = 0\text{ V}, V_{GE} = 20\text{ V}$	$T_j = 25^\circ\text{C}$			nA
		$T_j = 125^\circ\text{C}$			nA
V_{CE0}		$T_j = 25^\circ\text{C}$	1,2	1,3	V
		$T_j = 125^\circ\text{C}$	1,1	1,2	V
r_{CE}	$V_{GE} = 15\text{ V}$	$T_j = 25^\circ\text{C}$	16	24	m Ω
		$T_j = 125^\circ\text{C}$	22	30	m Ω
$V_{CE(sat)}$	$I_{Cnom} = 50\text{ A}, V_{GE} = 15\text{ V}$	$T_j = 25^\circ\text{C}_{chiplev.}$	2	2,5	V
		$T_j = 125^\circ\text{C}_{chiplev.}$	2,2		V
C_{ies}	$V_{CE} = 25\text{ V}, V_{GE} = 0\text{ V}$	$f = 1\text{ MHz}$	2,7		nF
C_{oes}			0,25		nF
C_{res}			0,153		nF
$t_{d(on)}$	$R_{Gon} = 15\ \Omega$	$V_{CC} = 300\text{ V}$ $I_C = 50\text{ A}$	35		ns
t_r			35		ns
E_{on}	$R_{Goff} = 15\ \Omega$	$T_j = 125^\circ\text{C}$ $V_{GE} = \pm 15\text{ V}$	1,3		mJ
$t_{d(off)}$			240		ns
t_f			25		ns
E_{off}			0,6		mJ
$R_{th(j-s)}$	per IGBT	1			K/W

SK35GD065ET

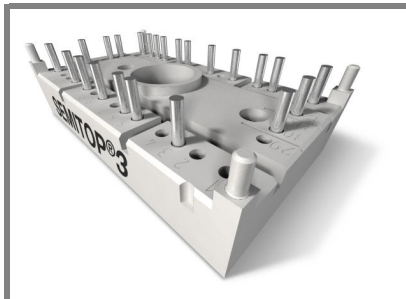

SEMITOP® 3

IGBT Module

SK35GD065ET

Preliminary Data

Features

- Compact design
- One screw mounting
- Heat transfer and isolation through direct copper bonded aluminium oxide ceramic (DCB)
- Ultrafast NPT technology IGBT
- CAL technology FWD
- Integrated NTC temperature sensor

Typical Applications*

- Inverter

Characteristics					
Symbol	Conditions	min.	typ.	max.	Units
Inverse Diode					
$V_F = V_{EC}$	$I_{Fnom} = 50 \text{ A}; V_{GE} = 0 \text{ V}$	$T_j = 25 \text{ }^\circ\text{C}_{chiplev.}$	1,9	2,3	V
		$T_j = 125 \text{ }^\circ\text{C}_{chiplev.}$	1,9	2,4	V
V_{F0}		$T_j = 25 \text{ }^\circ\text{C}$	1	1,1	V
		$T_j = 125 \text{ }^\circ\text{C}$	0,9		V
r_F		$T_j = 25 \text{ }^\circ\text{C}$	18	24	mΩ
		$T_j = 125 \text{ }^\circ\text{C}$	20	28	mΩ
I_{RRM}	$I_F = 50 \text{ A}$	$T_j = 125 \text{ }^\circ\text{C}$	57		A
Q_{rr}	$di/dt = -2400 \text{ A}/\mu\text{s}$		4,6		μC
E_{rr}	$V_{CC} = 300\text{V}$		0,9		mJ
$R_{th(j-s)D}$	per diode			1,7	K/W
M_s	to heat sink	2,25		2,5	Nm
w			30		g
Temperature sensor					
R_{100}	$T_s = 100^\circ\text{C} (R_{25} = 5\text{k}\Omega)$		493±5%		Ω

This is an electrostatic discharge sensitive device (ESDS), international standard IEC 60747-1, Chapter IX.

* The specifications of our components may not be considered as an assurance of component characteristics. Components have to be tested for the respective application. Adjustments may be necessary. The use of SEMIKRON products in life support appliances and systems is subject to prior specification and written approval by SEMIKRON. We therefore strongly recommend prior consultation of our staff.

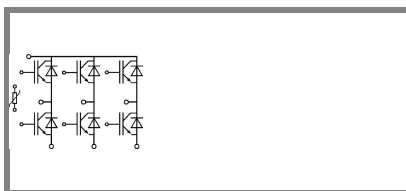

GD-ET

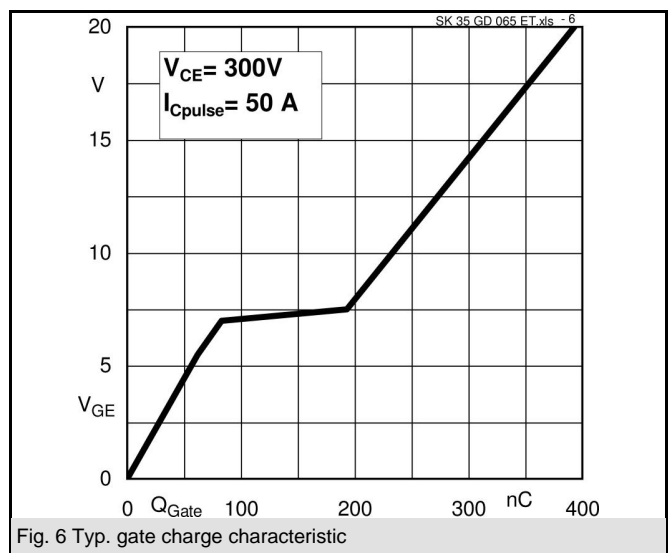
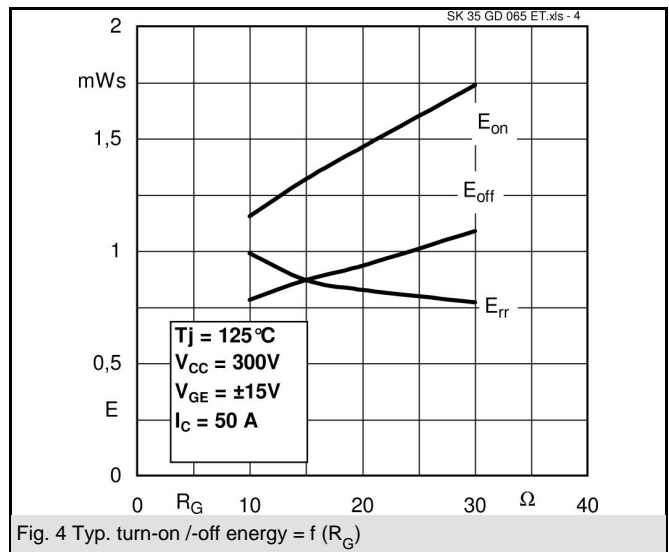
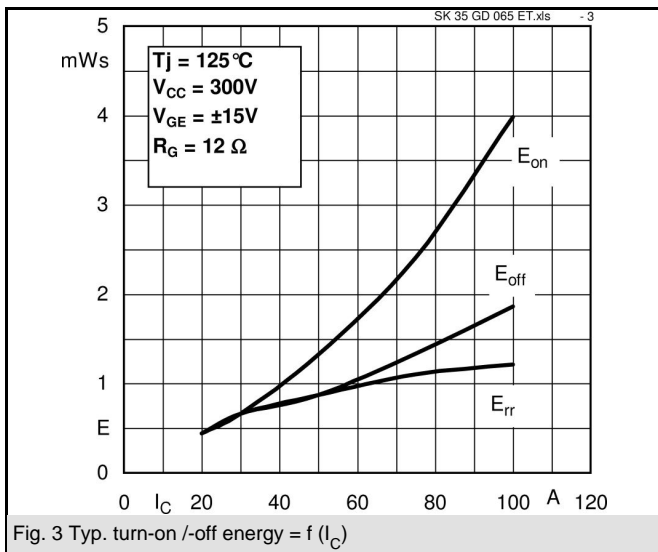
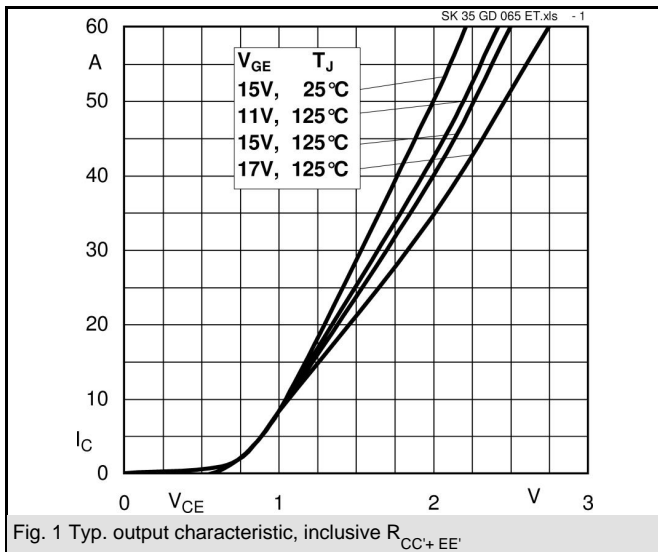

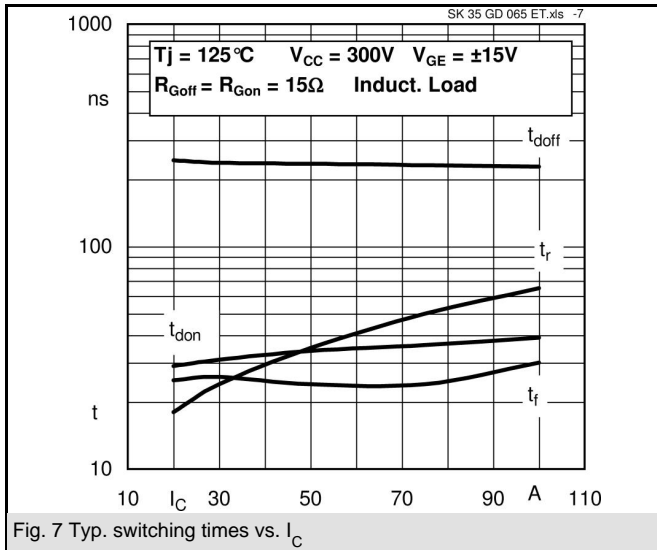

Fig. 7 Typ. switching times vs. I_C

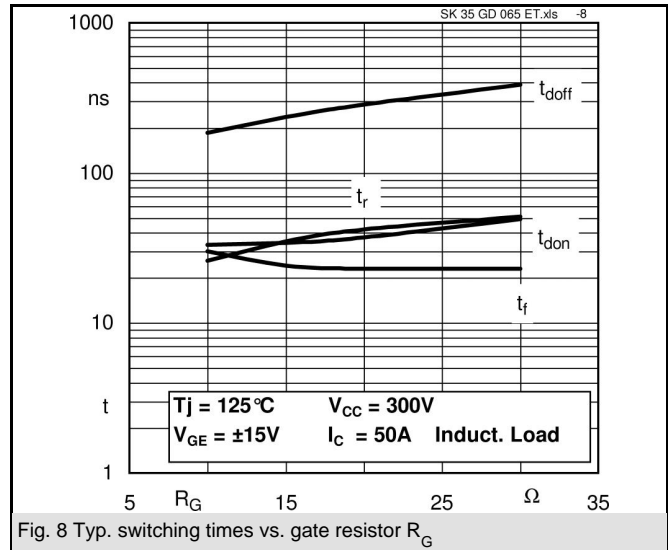

Fig. 8 Typ. switching times vs. gate resistor R_G

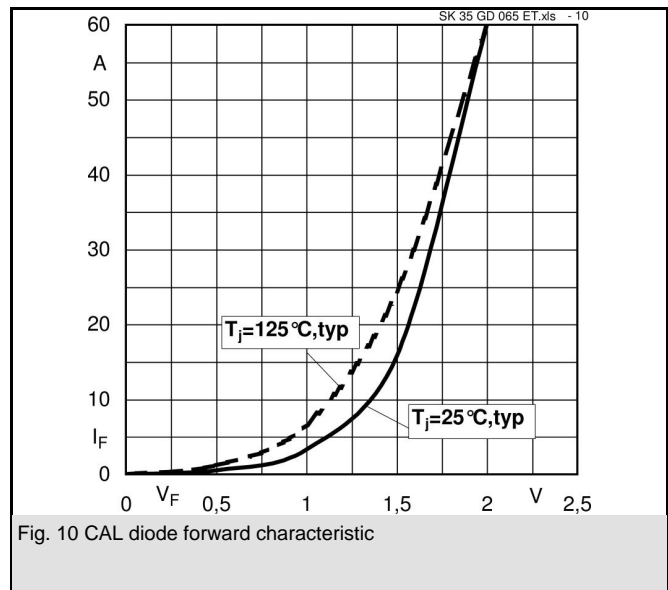
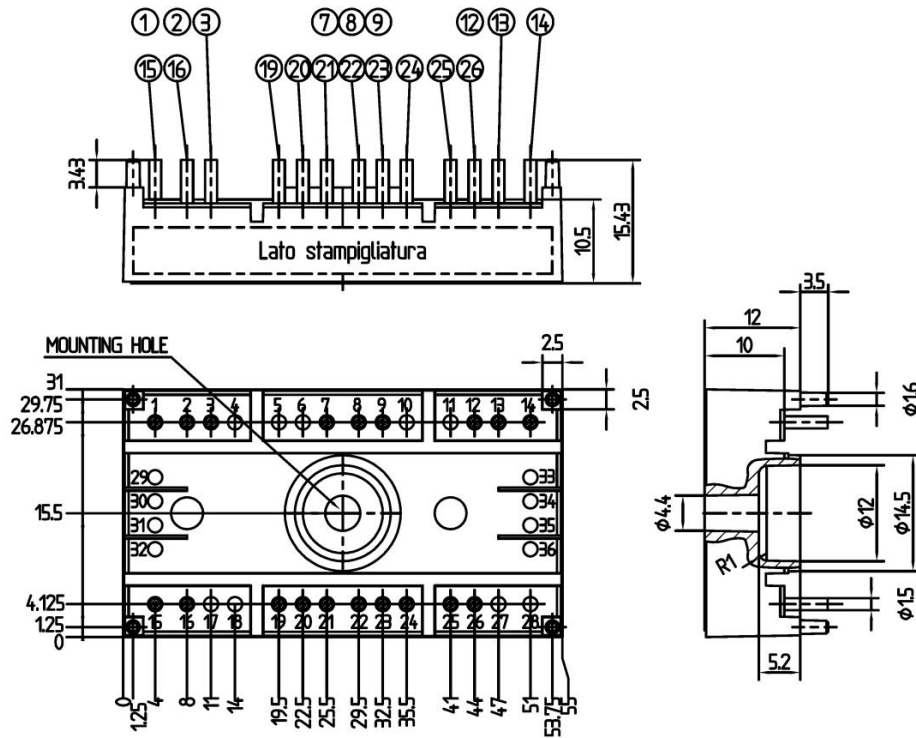

Fig. 10 CAL diode forward characteristic

SK35GD065ET

UL recognized file

no. E 63 532



Case T52 (Suggested hole diameter, in the PCB, for solder pins and plastic mounting pins: 2mm)

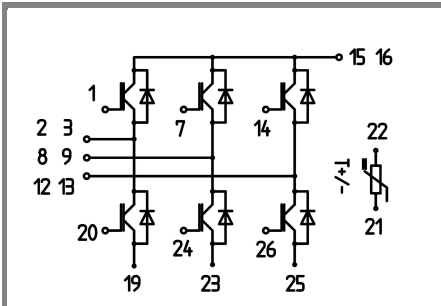

Case T 52

GD-ET