

# SKiIP 25NAB065V1

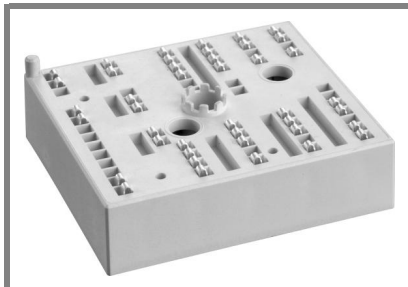

MiniSKiIP<sup>®</sup> 2

3-phase bridge rectifier +  
brake chopper + 3-phase  
bridge inverter  
SKiIP 25NAB065V1

## Features

- Ultrafast NPT IGBTs
- Robust and soft freewheeling diodes in CAL technology
- Highly reliable spring contacts for electrical connections
- UL recognised file no. E63532

## Typical Applications\*

- Inverter up to 10 kVA
- Typical motor power 4,0 kW

## Remarks

- $V_{CEsat}$ ,  $V_F$  = chip level value

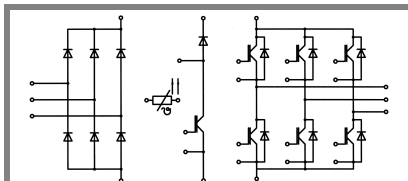

NAB

Absolute Maximum Ratings		$T_s = 25^\circ\text{C}$ , unless otherwise specified		
Symbol	Conditions	Values	Units	
<b>IGBT - Inverter, Chopper</b>				
$V_{CES}$	$T_s = 25 (70)^\circ\text{C}$	600	V	
$I_C$		38 (28)	A	
$I_{CRM}$		60	A	
$V_{GES}$		$\pm 20$	V	
$T_j$		- 40 ... + 150	$^\circ\text{C}$	
<b>Diode - Inverter, Chopper</b>				
$I_F$	$T_s = 25 (70)^\circ\text{C}$	40 (30)	A	
$I_{FRM}$		60	A	
$T_j$		- 40 ... + 150	$^\circ\text{C}$	
<b>Diode - Rectifier</b>				
$V_{RRM}$	$T_s = 70^\circ\text{C}$	800	V	
$I_F$		46	A	
$I_{FSM}$		$t_p = 10 \text{ ms, sin } 180^\circ, T_j = 25^\circ\text{C}$	370	A
$i^2t$		$t_p = 10 \text{ ms, sin } 180^\circ, T_j = 25^\circ\text{C}$	680	$\text{A}^2\text{s}$
$T_j$		- 40 ... + 150	$^\circ\text{C}$	
<b>Module</b>				
$I_{RMS}$	per power terminal (20 A / spring)	60	A	
$T_{stg}$		- 40 ... + 125	$^\circ\text{C}$	
$V_{isol}$	AC, 1 min.	2500	V	

Characteristics		$T_s = 25^\circ\text{C}$ , unless otherwise specified			
Symbol	Conditions	min.	typ.	max.	Units
<b>IGBT - Inverter, Chopper</b>					
$V_{CEsat}$	$I_{Cnom} = 30 \text{ A}, T_j = 25 (125)^\circ\text{C}$		2 (2,2)	2,5 (2,7)	V
$V_{GE(th)}$	$V_{GE} = V_{CE}, I_C = 0,5 \text{ mA}$	3	4	5	V
$V_{CE(TO)}$	$T_j = 25 (125)^\circ\text{C}$		1,2 (1,1)	1,3 (1,2)	V
$r_T$	$T_j = 25 (125)^\circ\text{C}$		27 (37)	40 (50)	$\text{m}\Omega$
$C_{ies}$	$V_{CE} = 25 \text{ V}, V_{GE} = 0 \text{ V}, f = 1 \text{ MHz}$		1,5		nF
$C_{oes}$	$V_{CE} = 25 \text{ V}, V_{GE} = 0 \text{ V}, f = 1 \text{ MHz}$		0,45		nF
$C_{res}$	$V_{CE} = 25 \text{ V}, V_{GE} = 0 \text{ V}, f = 1 \text{ MHz}$		0,35		nF
$R_{th(j-s)}$	per IGBT		1,05		K/W
$t_{d(on)}$	under following conditions		20		ns
$t_r$	$V_{CC} = 300 \text{ V}, V_{GE} = \pm 15 \text{ V}$		20		ns
$t_{d(off)}$	$I_{Cnom} = 30 \text{ A}, T_j = 125^\circ\text{C}$		185		ns
$t_f$	$R_{Gon} = R_{Goff} = 20 \Omega$		15		ns
$E_{on}$	inductive load		1		mJ
$E_{off}$			0,6		mJ
<b>Diode - Inverter, Chopper</b>					
$V_F = V_{EC}$	$I_{Fnom} = 30 \text{ A}, T_j = 25 (125)^\circ\text{C}$		1,5 (1,5)	1,8 (1,8)	V
$V_{(TO)}$	$T_j = 25 (125)^\circ\text{C}$		1 (0,9)	1,1 (1)	V
$r_T$	$T_j = 25 (125)^\circ\text{C}$		18 (20)	23 (27)	$\text{m}\Omega$
$R_{th(j-s)}$	per diode		1,5		K/W
$I_{RRM}$	under following conditions		45		A
$Q_{rr}$	$I_{Fnom} = 30 \text{ A}, V_R = 300 \text{ V}$		3,1		$\mu\text{C}$
$E_{rr}$	$V_{GE} = 0 \text{ V}, T_j = 125^\circ\text{C}$		0,8		mJ
	$di_F/dt = 2040 \text{ A}/\mu\text{s}$				
<b>Diode - Rectifier</b>					
$V_F$	$I_{Fnom} = 25 \text{ A}, T_j = 25^\circ\text{C}$		1,1		V
$V_{(TO)}$	$T_j = 150^\circ\text{C}$		0,8		V
$r_T$	$T_j = 150^\circ\text{C}$		13		$\text{m}\Omega$
$R_{th(j-s)}$	per diode		1,25		K/W
<b>Temperature Sensor</b>					
$R_{ts}$	3 %, $T_r = 25 (100)^\circ\text{C}$		1000(1670)		$\Omega$
<b>Mechanical Data</b>					
w			65		g
$M_s$	Mounting torque	2		2,5	Nm

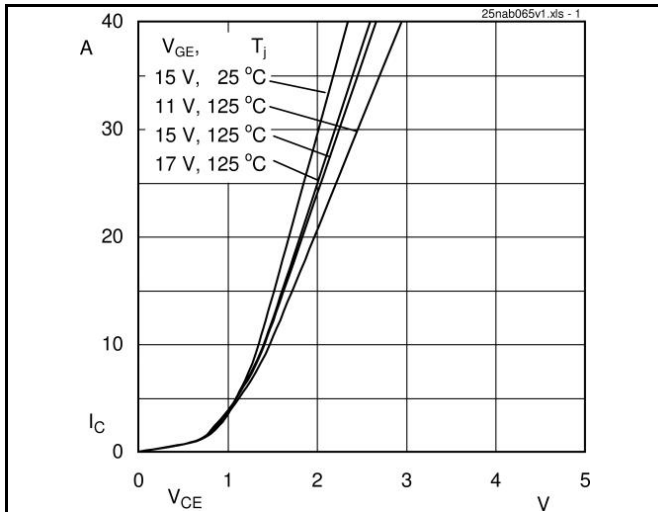

Fig. 1 Typ. output characteristic

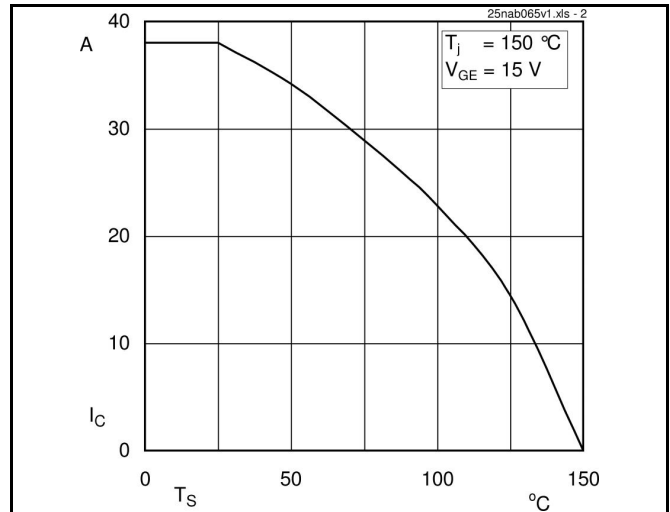

Fig. 2 Typ. rated current vs. temperature

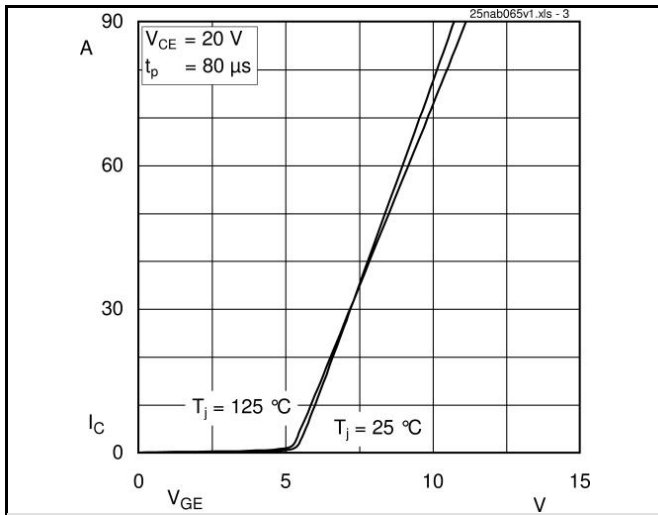

Fig. 3 Typ. transfer characteristic

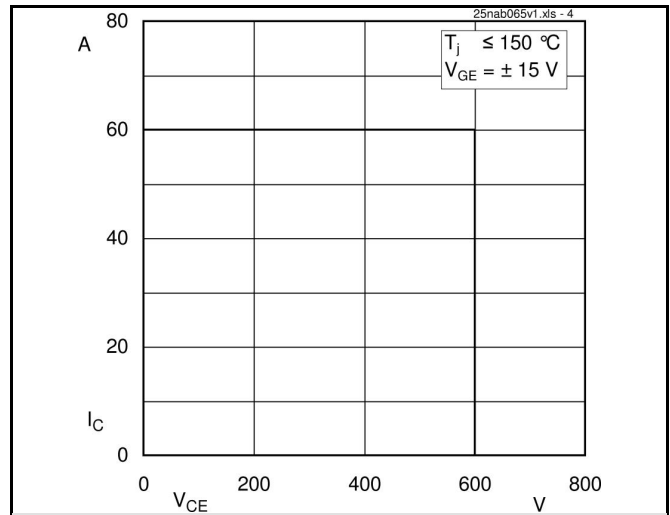

Fig. 4 Reverse bias safe operating area

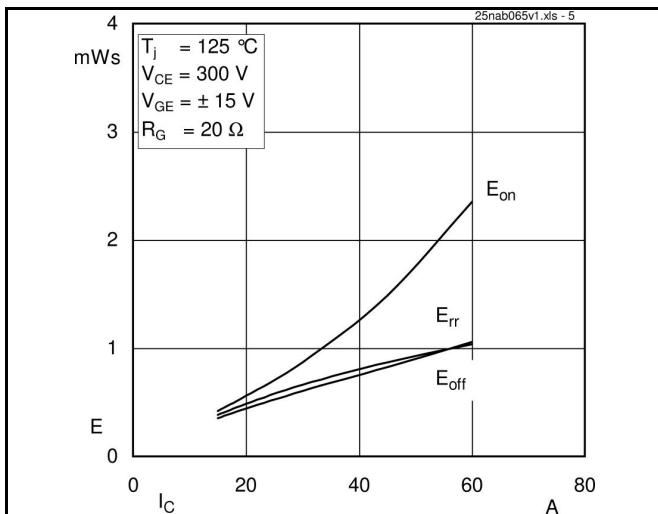

Fig. 5 Typ. Turn-on /-off energy =  $f(I_C)$

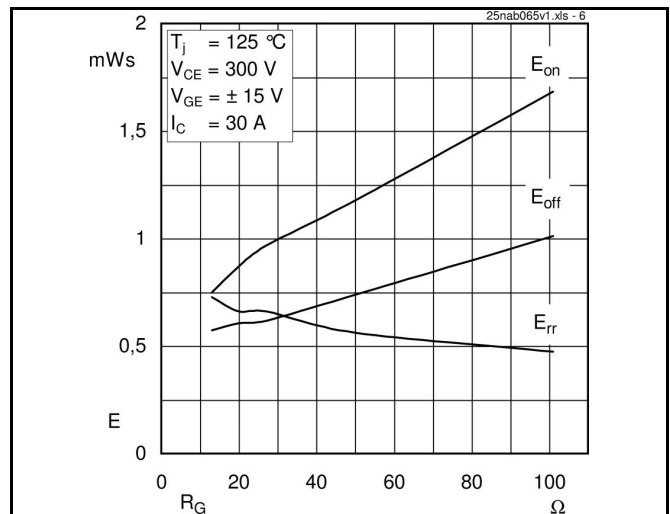

Fig. 6 Typ. Turn-on /-off energy =  $f(R_G)$

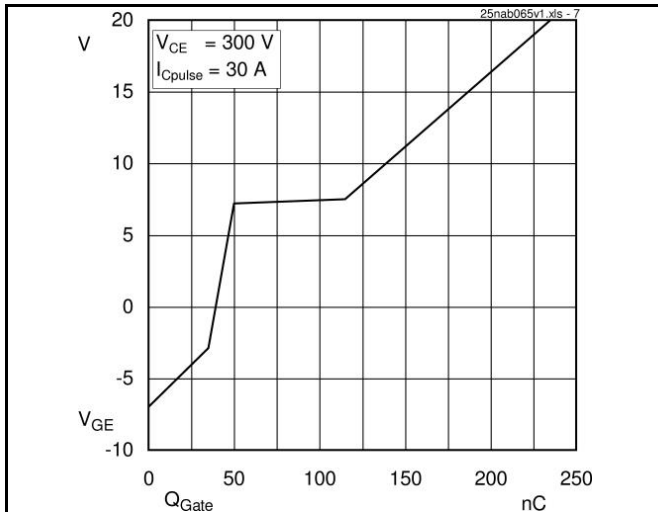

Fig. 7 Typ. gate charge characteristic

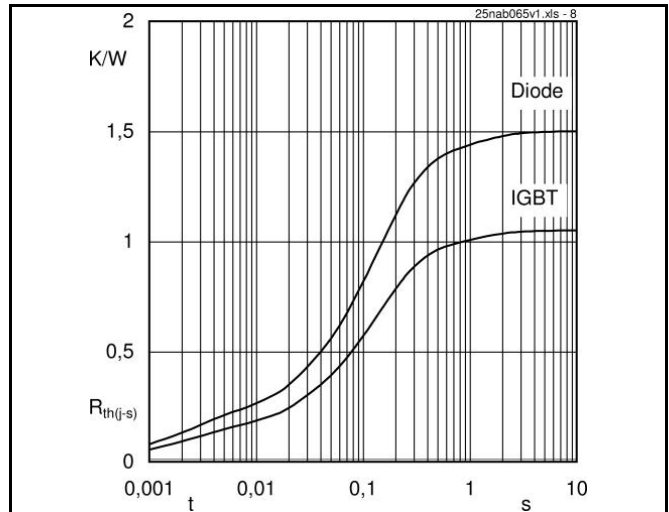

Fig. 8 Typ. thermal impedance

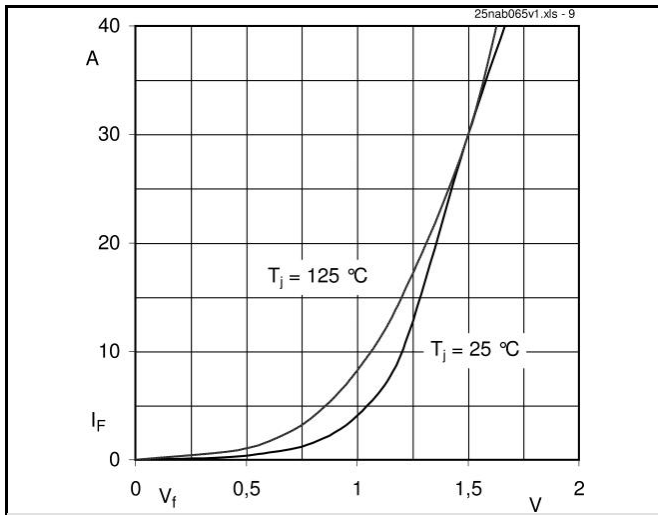

Fig. 9 Typ. freewheeling diode forward characteristic

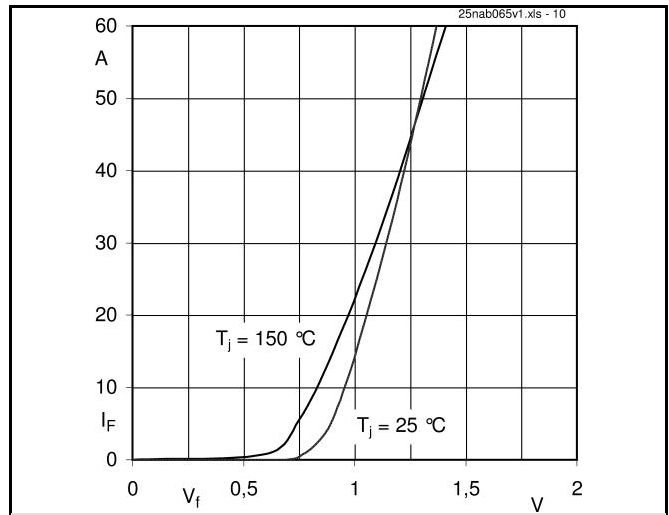
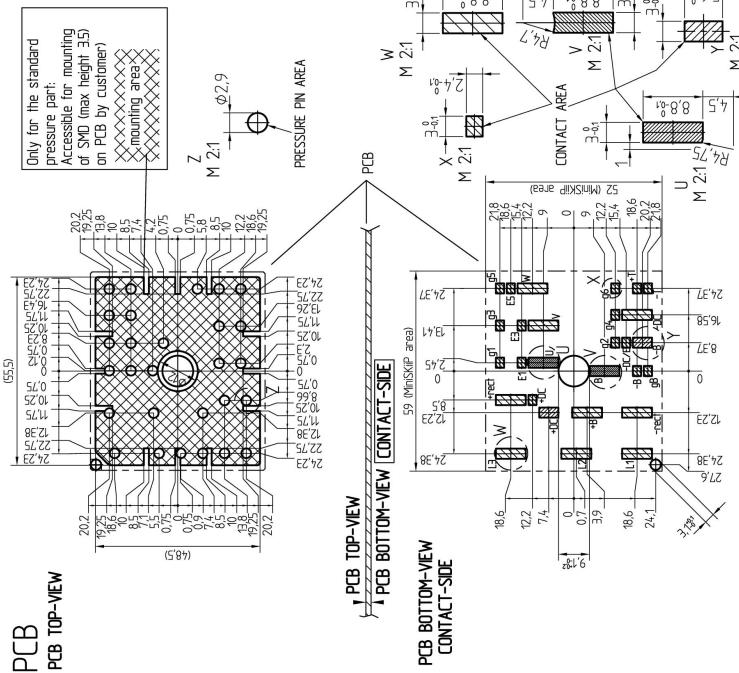
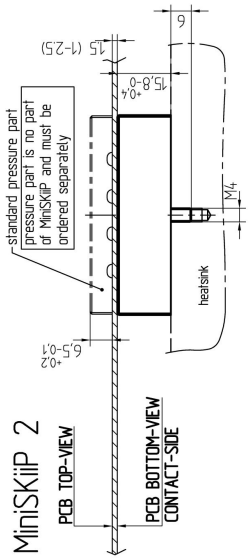
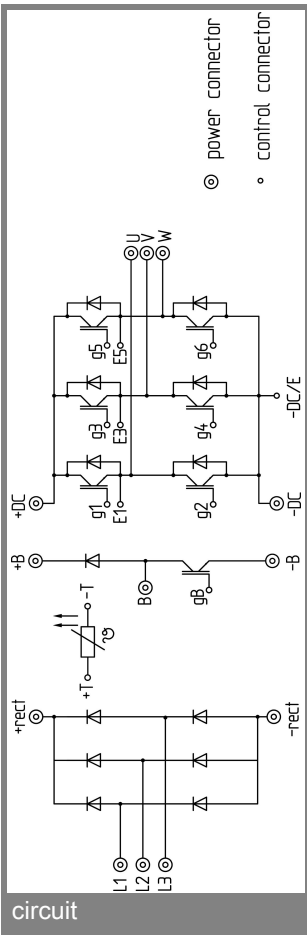

Fig. 10 Typ. input bridge forward characteristic

# SKiIP 25NAB065V1



pinout, dimensions

These documents are Semikron property. Semikron reserves all copyrights. All copying and transmitting of this information requires written permission from the case of industrial property rights. Semikron reserves all rights.

This is an electrostatic discharge sensitive device (ESDS), international standard IEC 60747-1, Chapter IX.

\* The specifications of our components may not be considered as an assurance of component characteristics. Components have to be tested for the respective application. Adjustments may be necessary. The use of SEMIKRON products in life support appliances and systems is subject to prior specification and written approval by SEMIKRON. We therefore strongly recommend prior consultation of our personal.