

LOC	DIST	REVISIONS					
E	B	P	LTR	DESCRIPTION	DATE	DWN	APVD
			BA	NEW RELEASE	20-Sep-08	SM	St.P

FOR FURTHER INFORMATION SEE DATA SHEET FOR
CFR SERIES-CARBON FILM FIXED RESISTORS

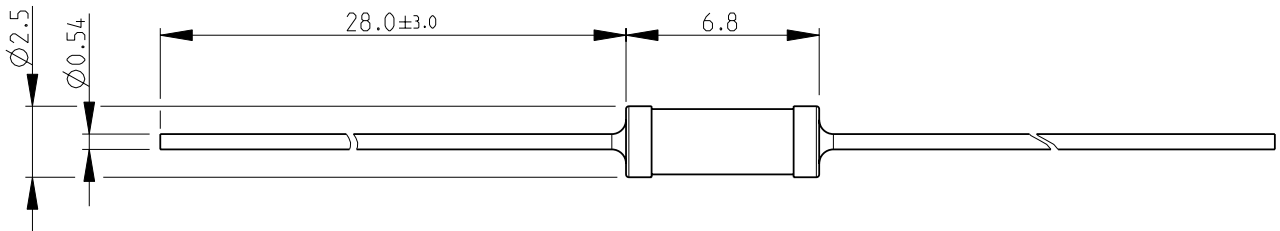

RoHS Compliant

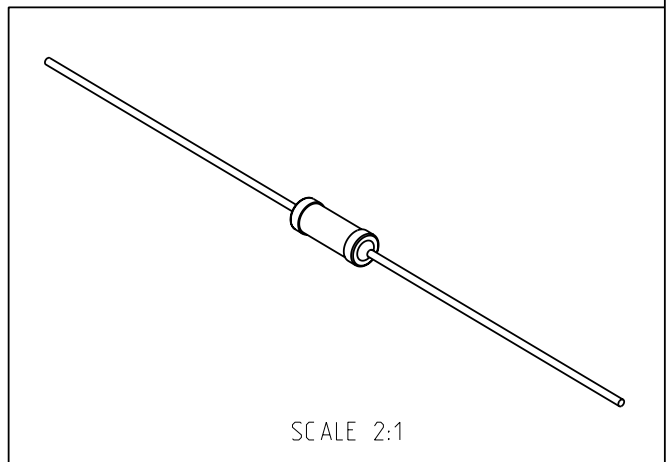

2008
 RELEASED FOR PUBLICATION
 THIS DRAWING IS UNPUBLISHED.
 © COPYRIGHT 2008 BY TYCO ELECTRONICS CORPORATION. ALL RIGHTS RESERVED.

DIMENSIONS: mm TOLERANCES UNLESS OTHERWISE SPECIFIED: 0 PLC ± 0.2 1 PLC ± 0.1 2 PLC $\pm -$ 3 PLC $\pm -$ 4 PLC $\pm -$ ANGLES $\pm 5^\circ$	DWN SUBHASH.M	20-Sep-08	MATERIAL	-	FINISH	-
	CHK PRAKASH.S	20-Sep-08	Tyco Electronics Corporation Dorcan, Swindon, SN3 5HH			
	APVD STEPHEN.P	20-Sep-08	NAME	CARBON FILM FIXED RESISTORS SERIES CFR25		
	PRODUCT SPEC	-	SIZE	CAGE CODE	DRAWING NO	RESTRICTED TO
	APPLICATION SPEC	-	A 4	00779	©= 1623931	-
	WEIGHT	-	CUSTOMER DRAWING		SCALE	4:1
					SHEET	1 OF 1
					REV	BA