



FEATURES

- Ultra Low Dropout - 0.2V(typical) at 1A Output Current
- Low ESR Output Capacitor (Multi-layer Chip Capacitors (MLCC)) Applicable
- 0.8V Reference Voltage
- Fast Transient Response
- Adjustable Output Voltage by External Resistors
- Power-On-Reset Monitoring on Both VCNTL and VIN Pins
- Internal Soft-Start
- Under-Voltage Protection
- Current-Limit and Thermal Shutdown Protection
- Power-OK Output with a Delay Time
- ESOP-8, SOT-26 and DFN 2x2 Pb-Free Packages.

DESCRIPTION

The APE8901 is a 1A ultra low dropout linear regulator. This product is specifically designed to provide well supply voltage for front-side-bus termination on motherboards and NB applications. The IC needs two supply voltages, a control voltage for the circuitry and a main supply voltage for power conversion, to reduce power dissipation and provide extremely low dropout. The APE8901 integrates many functions. A Power-On-Reset (POR) circuit monitors both supply voltages to prevent wrong operations. A thermal shutdown and current limit functions protect the device against thermal and current over-loads. A POK indicates the output status with time delay which is set internally. It can control other converter for power sequence. The APE8901 can be enabled by other power system. Pulling and holding the EN pin below 0.3V shuts off the output.

The APE8901 is available in ESOP-8, SOT-26 and DFN 2x2 packages. That features small size as SOP-8 with an Exposed Pad to reduce the junction-to-case resistance, being applicable in 2~3W applications.

TYPICAL APPLICATION CIRCUIT

1. Using an Output Capacitor with ESR $\geq 20m\Omega$

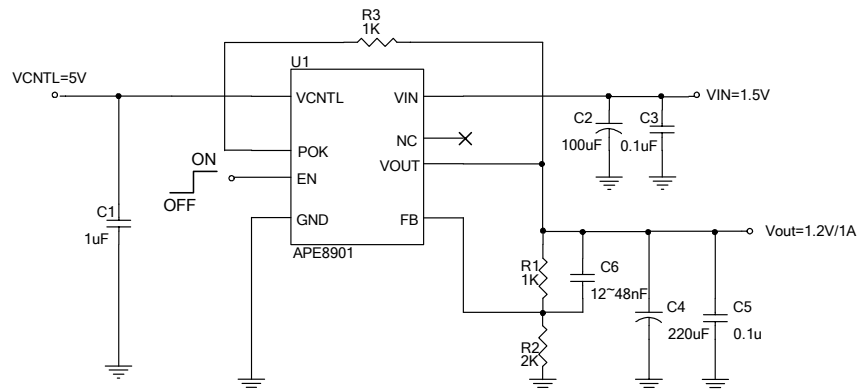

2. Using an MLCC as the Output Capacitor

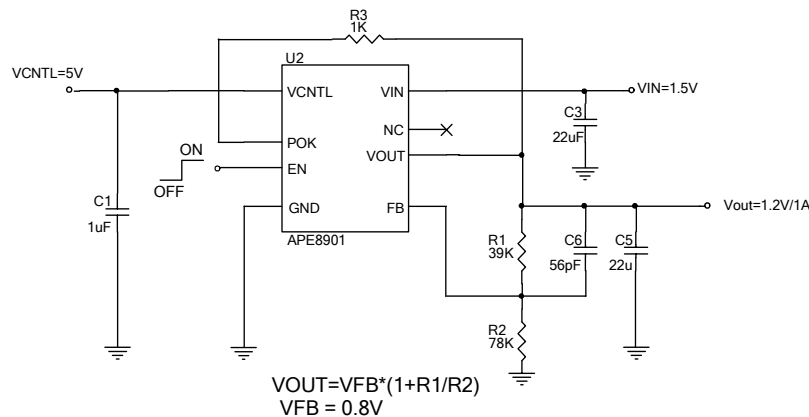



ABSOLUTE MAXIMUM RATINGS (at $T_A=25^{\circ}\text{C}$)

VCNTL Supply Voltage (V_{CNTL})	-----	-0.3V to 7V
VIN Supply Voltage (V_{IN})	-----	-0.3V to 6V
EN & FB Pin Voltage ($V_{\text{I/O}}$)	-----	-0.3V to $V_{\text{CNTL}}+0.3\text{V}$
Power Voltage (V_{POK})	-----	-0.3V to 7V
Power Dissipation (P_{D})		
	ESOP-8 -----	3W
	SOT-26 -----	0.4W
	DFN 2x2 -----	0.8W
Storage Temperature Range (T_{ST})	-----	-65°C To 150°C
Junction Temperature Range (T_{J})	-----	-40°C To 125°C
Operating Temperature Range (T_{OP})	-----	-40°C To 85°C
Thermal Resistance Junction to Ambient (R_{thja})		
	ESOP-8 -----	40°C/W
	SOT-26 -----	250°C/W
	DFN 2x2 -----	125°C/W
Thermal Resistance Junction to Case (R_{thjc})		
	ESOP-8 -----	15°C/W
	SOT-26 -----	180°C/W
	DFN 2x2 -----	20°C/W

Note. R_{thja} is measured with the PCB copper area (need connect to Expose-Pad) of approximately 1.5 in2 (Multi-layer) by ESOP-8 and DFN-8L packages.

RECOMMENDED OPERATING CONDITIONS

V_{CNTL} Supply Voltage (V_{CNTL})	-----	3V to 6V
VIN Supply Voltage (V_{IN})	-----	1V to 5.5V
Output Voltage (V_{OUT})	-----($V_{\text{CNTL}}-V_{\text{OUT}} > 1.9\text{V}$)----	0.8V to 2.8V
Output Current (I_{OUT})	-----	0 to 1A

ORDERING INFORMATION

APE8901X

Package Type
MP : ESOP-8
Y : SOT-26
GN2 : DFN 2x2

PACKAGE INFORMATION

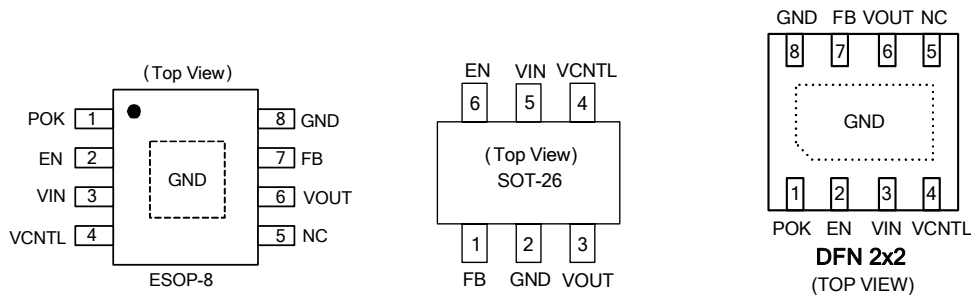



ELECTRICAL SPECIFICATIONS

($V_{CNTL} = 5V$, $V_{IN} = 1.5V$, $V_{OUT} = 1.2V$, $T_A = 25^\circ C$ unless otherwise specified)

Parameter	SYM	TEST CONDITION	MIN	TYP	MAX	UNITS	
VCNTL POR Threshold	V_{CNTL}		2.5	2.7	2.9	V	
VCNTL POR Hysteresis	$V_{CNTL(hys)}$		-	0.4	-	V	
VIN POR Threshold	V_{IN}		0.8	0.9	1	V	
VIN POR Hysteresis	$V_{IN(hys)}$		-	0.5	-	V	
VCNTL Nominal Supply Current	I_{CNTL}	EN= V_{CNTL}	0.4	1	2	mA	
VCNTL Shutdown Current	I_{SD}	EN= 0V	-	10	30	uA	
Feedback Voltage	V_{FB}	$V_{CNTL} = 3 \sim 6.0V$	0.784	0.8	0.816	V	
Load Regulation		$I_{OUT} = 0A \sim 1A$	-	0.06	0.25	%	
Dropout Voltage	V_{DROP}	$V_{OUT} < 2.0V, I_{OUT} = 1A$	-	200	250	mV	
		$2.0V < V_{OUT} < 2.8V, I_{OUT} = 1A$	-	250	300		
VOUT Pull Low Resistance		EN=0V	-	90	120	Ω	
Soft Start Time	T_{SS}		-	2	-	mS	
EN Pin Logic High Threshold Voltage	V_{ENH}	Enable	1.2	-	-	V	
	V_{ENL}	Disable	-	-	0.4		
EN Hysteresis			-	50	-	mV	
EN Pin Pull-Up Current	I_{EN}	EN=GND	-	10	-	uA	
Current Limit	I_{LIM}	125°C	1.2	-	-	A	
Ripple Rejection	V_{IN}	PSRR	F=120Hz, $I_{OUT} = 100mA$	-	70	-	dB
	V_{CNTL}			-	65	-	
Under-Voltage Threshold		VFB Falling	-	0.4	-	V	
POK Threshold Voltage for Power OK	V_{POK}	VFB Rising	89%	92%	95%	VFB	
POK Threshold Voltage for Power Not OK	V_{PNOK}	VFB Falling	78%	81%	84%	VFB	
POK Low Voltage		POK sinks 5mA	-	0.25	0.4	V	
POK Delay Time	T_{DELAY}		0.8	2	10	mS	
Thermal Shutdown Temp	TSD		-	150	-	°C	
Thermal Shutdown Hysteresis			-	40	-	°C	

PIN DESCRIPTIONS

PIN SYMBOL	PIN DESCRIPTION
FB	Feedback Pin
EN	Internal Pull High. EN=High or Floating → Enable EN=Low → Shutdown Mode
VIN	Input voltage.
POK	Power OK Output Pin
VCNTL	CNTL Pin Input Voltage
NC	No connect
VOUT	Output Voltage
GND	GND Pin.



BLOCK DIAGRAM

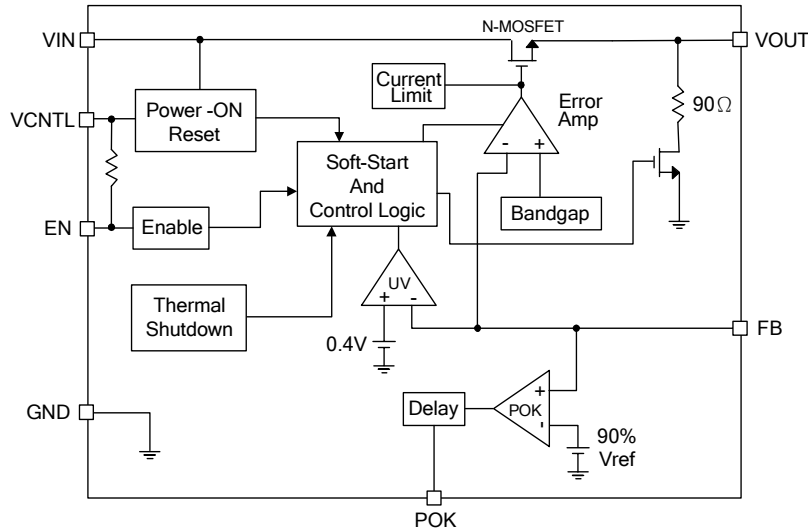

PIN DESCRIPTION

FB

Connecting this pin to an external resistor divider receives the feedback voltage of the regulator. The output voltage set by the resistor divider is determined by:

$$V_{OUT} = 0.8 \cdot \left(1 + \frac{R1}{R2} \right) \quad (V)$$

Where R1 is connected from VOUT to FB with Kelvin sensing and R2 is connected from FB to GND. A bypass capacitor may be connected with R1 in parallel to improve load transient response. The recommended R2 and R1 are in the range of 1K~100kΩ.

VIN

Main supply input pins for power conversions. The voltage at this pin is monitored for Power-On Reset purpose.

VCNTL

Power input pin of the control circuitry. Connecting this pin to a +5V (recommended) supply voltage provides the bias for the control circuitry. The voltage at this pin is monitored for Power-On Reset purpose.

POK

Power-OK signal output pin. This pin is an open-drain output used to indicate status of output voltage by sensing FB voltage. This pin is pulled low when the rising FB voltage is not above the VPOK threshold or the falling FB voltage is below the VPOK threshold, indicating the output is not OK.

EN

Enable control pin. Pulling and holding this pin below 0.4V shuts down the output. When re-enabled, the IC undergoes a new soft-start cycle. Left this pin open, this pin is internal pulled up to VCNTL voltage, enabling the regulator.



PIN DESCRIPTION

VOUT

Output of the regulator. Please connect Pin 6 using wide tracks. It is necessary to connect an output capacitor with this pin for closed-loop compensation and improving transient responses.

FUNCTION DESCRIPTION

Power-On-Reset

A Power-On-Reset (POR) circuit monitors both input voltages at VCNTL and VIN pins to prevent wrong logic controls. The POR function initiates a soft-start process after the two supply voltages exceed their rising POR threshold voltages during powering on. The POR function also pulls low the POK pin regardless the output voltage when the VCNTL voltage falls below its falling POR threshold.

Internal Soft-Start

An internal soft-start function controls rise rate of the output voltage to limit the current surge at start-up. The typical soft-start interval is about 2mS.

Output Voltage Regulation

An error amplifier working with a temperature compensated 0.8V reference and an output NMOS regulates output to the preset voltage. The error amplifier designed with high bandwidth and DC gain provides very fast transient response and less load regulation. It compares the reference with the feedback voltage and amplifies the difference to drive the output NMOS which provides load current from VIN to VOUT.

Current-Limit

The APE8901 monitors the current via the output NMOS and limits the maximum current to prevent load and APE8901 from damages during overload or short circuit conditions.

Under-Voltage Protection (UVP)

The APE8901 monitors the voltage on FB pin after soft-start process is finished. Therefore the UVP is disabling during soft-start. When the voltage on FB pin falls below the under-voltage threshold, the UVP circuit shuts off the output immediately. After a while, the APE8901 starts a new soft-start to regulate output.

Thermal Shutdown

A thermal shutdown circuit limits the junction temperature of APE8901. When the junction temperature exceeds +150°C, a thermal sensor turns off the output NMOS, allowing the device to cool down. The regulator regulates the output again through initiation of a new soft-start cycle after the junction temperature cools by 40°C, resulting in a pulsed output during continuous thermal overload conditions. The thermal shutdown designed



TYPICAL PERFORMANCE CHARACTERISTICS

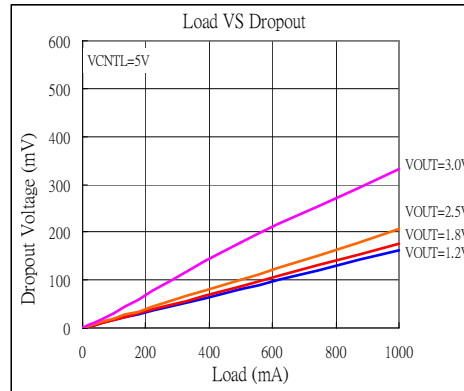
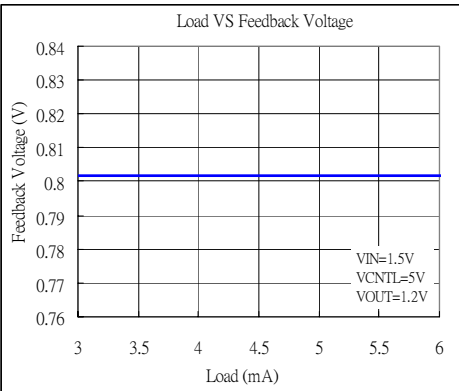
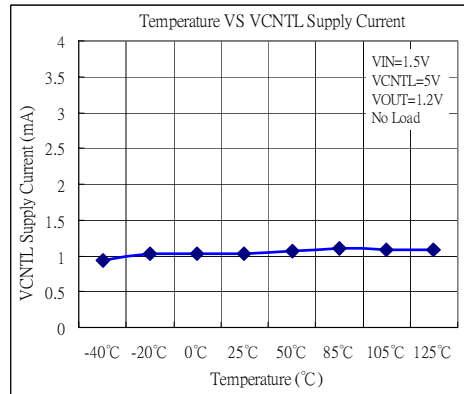
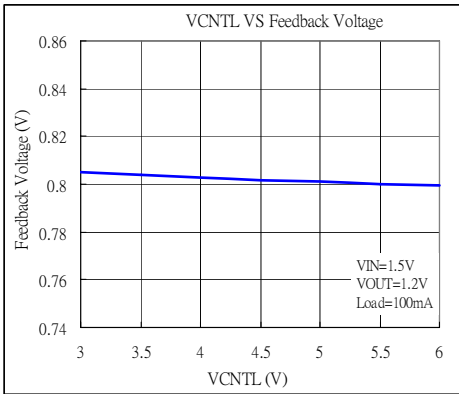
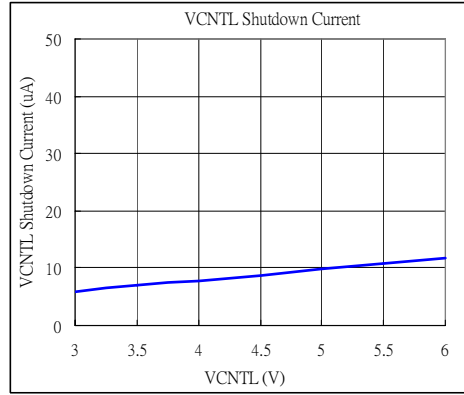
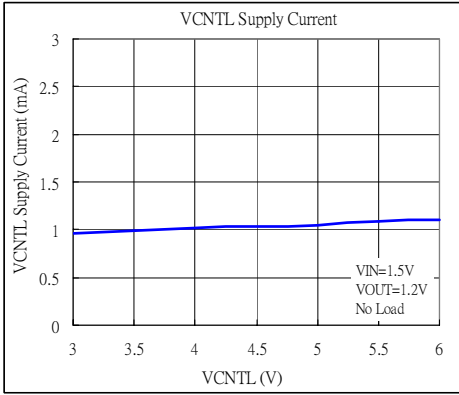



TYPICAL PERFORMANCE CHARACTERISTICS

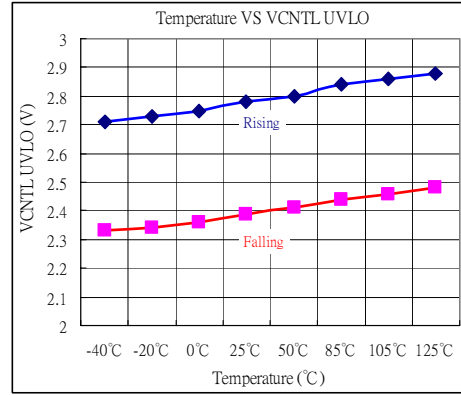
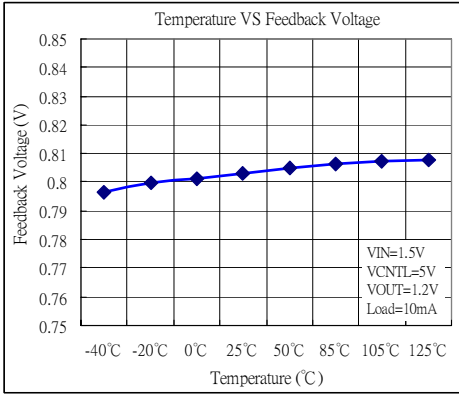

Power -ON (VIN=1.5V, VCNTL=5V, VOUT=1.2V, Laod=1A)

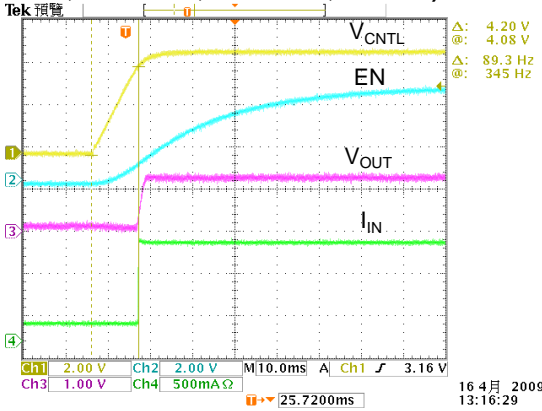

Load Transient (VIN=1.5V, VCNTL=5V, VOUT=1.2V, Laod=10m~1A)

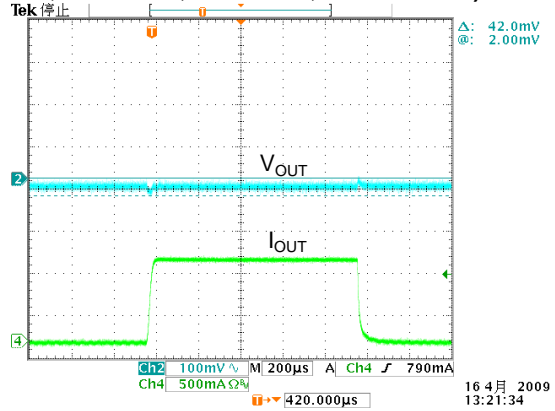

Enable -ON (VIN=1.5V, VCNTL=5V, VOUT=1.2V, Laod=1A)

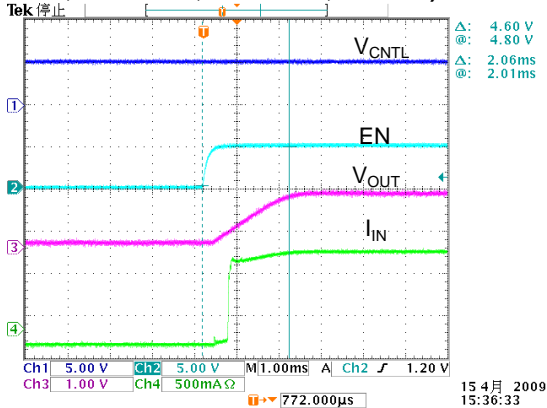

Enable -OFF (VIN=1.5V, VCNTL=5V, VOUT=1.2V, No Laod)

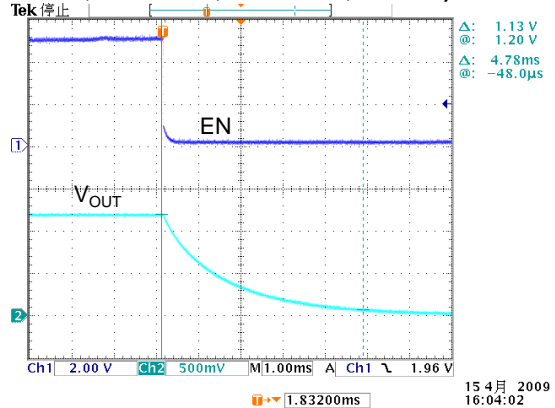



Package Outline : SOT-26

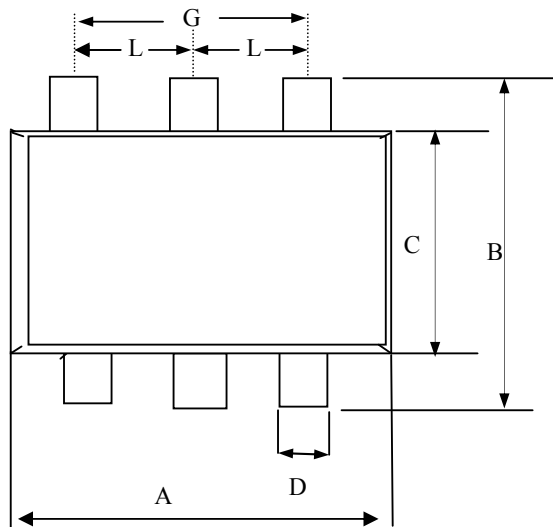

SYMBOLS	Millimeters		
	MIN	NOM	MAX
A	2.70	2.90	3.10
B	2.60	2.80	3.00
C	1.40	1.60	1.80
D	0.30	0.43	0.55
E	0.00	0.05	0.10
H	1.20REF		
G	1.90REF		
I	0.12REF		
J	0.37REF		
L	0.95REF		

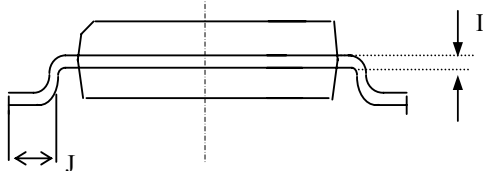
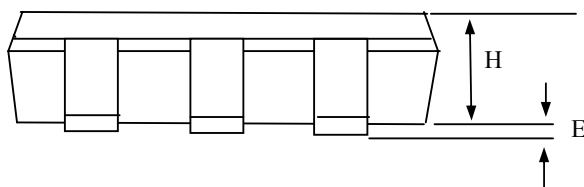

- 1.All Dimension Are In Millimeters.
- 2.Dimension Does Not Include Mold Protrusions.

Part Marking Information & Packing : SOT-26

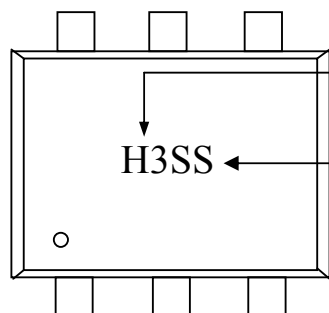

Part Number : H3

Date Code

SS:2004,2008,2012...

SS:2003,2007,2011...

SS:2002,2006,2010...

SS:2001,2005,2009...

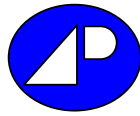

Package Outline : DFN 2x2

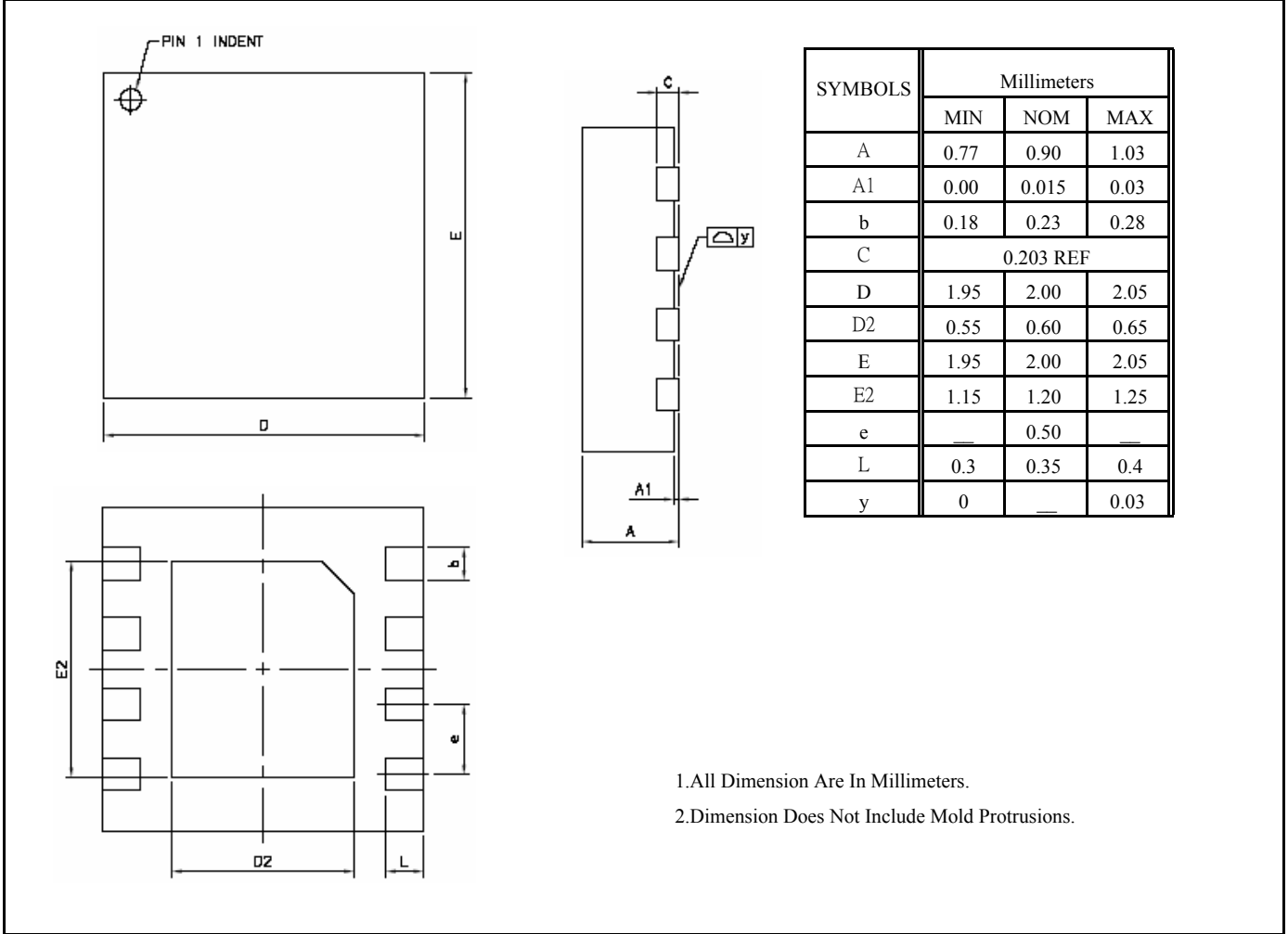

Part Marking Information & Packing : DFN 2x2

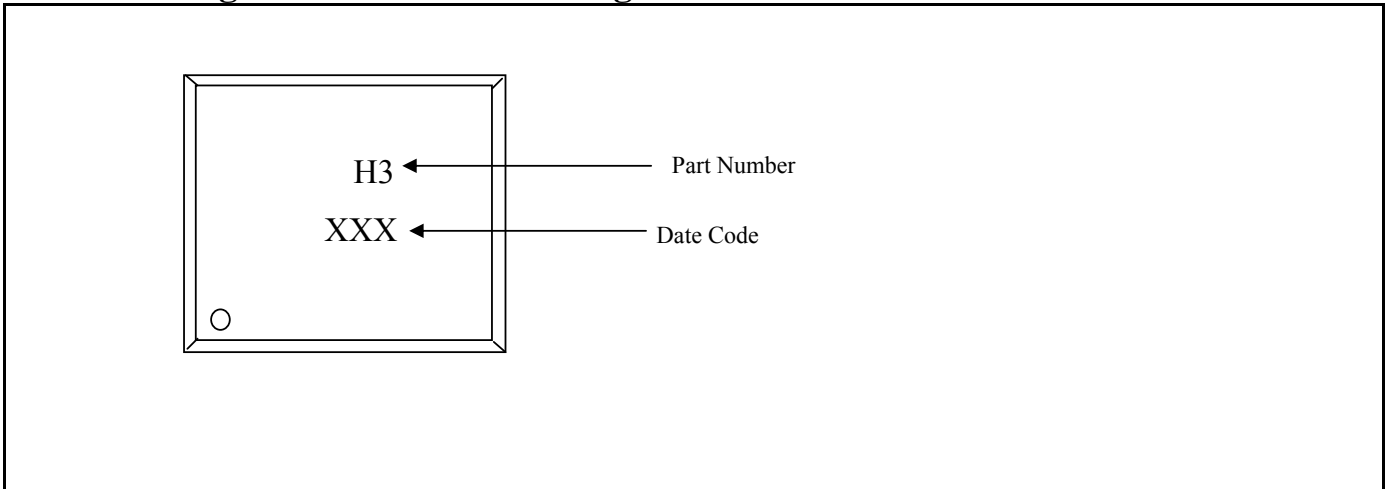



ADVANCED POWER ELECTRONICS CORP.

Package Outline : ESOP-8

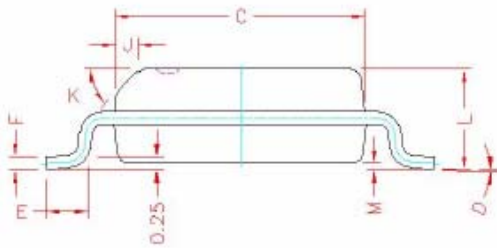
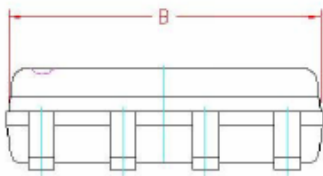
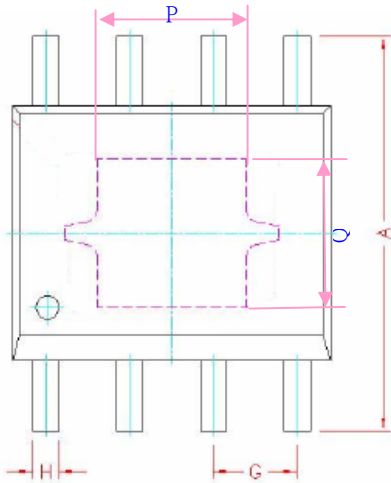

SYMBOLS	Millimeters		
	MIN	NOM	MAX
A	5.80	6.00	6.20
B	4.80	4.90	5.00
C	3.80	3.90	4.00
D	0°	4°	8°
E	0.40	0.65	0.90
F	0.19	0.22	0.25
M	0.00	0.08	0.15
H	0.35	0.42	0.49
L	1.35	1.55	1.75
J	0.375 REF.		
K	45°		
G	1.27 TYP.		
P	2.15	2.25	2.35
Q	2.15	2.25	2.35

1.All Dimension Are In Millimeters.

2.Dimension Does Not Include Mold Protrusions.

Part Marking Information & Packing : ESOP-8

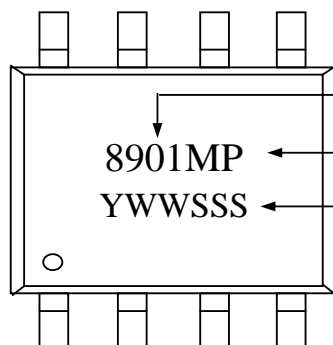

Part Number

8901MP

Package Code

YWWSSS

Date Code (YWWSSS)

Y : Last Digit Of The Year

WW : Week

SSS : Sequence

Draw No. M1-MP-8-G-v01