

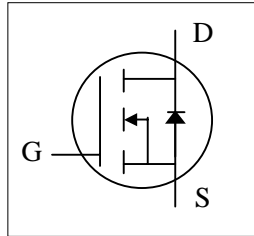

- ▼ 100% Avalanche Test
- ▼ Fast Switching Characteristic
- ▼ Simple Drive Requirement
- ▼ RoHS Compliant



BV_{DSS}	600V
$R_{DS(ON)}$	1.1 Ω
I_D	9A

Description

AP2764A series are specially designed as main switching devices for universal 90~265VAC off-line AC/DC converter applications.

TO-220CFM type provide high blocking voltage to overcome voltage surge and sag in the toughest power system with the best combination of fast switching, ruggedized design and cost-effectiveness.

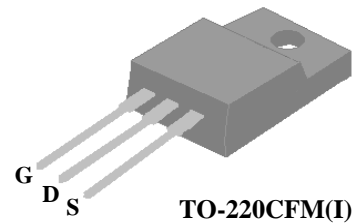

Absolute Maximum Ratings

Symbol	Parameter	Rating	Units
V_{DS}	Drain-Source Voltage	600	V
V_{GS}	Gate-Source Voltage	± 30	V
$I_D @ T_C = 25^\circ C$	Continuous Drain Current, $V_{GS} @ 10V$	9	A
$I_D @ T_C = 100^\circ C$	Continuous Drain Current, $V_{GS} @ 10V$	6	A
I_{DM}	Pulsed Drain Current ¹	36	A
$P_D @ T_C = 25^\circ C$	Total Power Dissipation	37	W
E_{AS}	Single Pulse Avalanche Energy ²	32	mJ
I_{AR}	Avalanche Current	8	A
T_{STG}	Storage Temperature Range	-55 to 150	$^\circ C$
T_J	Operating Junction Temperature Range	-55 to 150	$^\circ C$

Thermal Data

Symbol	Parameter	Value	Units
Rthj-c	Maximum Thermal Resistance, Junction-case	3.4	$^\circ C/W$
Rthj-a	Maximum Thermal Resistance, Junction-ambient	65	$^\circ C/W$



Electrical Characteristics @T_j=25°C(unless otherwise specified)

Symbol	Parameter	Test Conditions	Min.	Typ.	Max.	Units
BV _{DSS}	Drain-Source Breakdown Voltage	V _{GS} =0V, I _D =1mA	600	-	-	V
R _{DS(ON)}	Static Drain-Source On-Resistance ³	V _{GS} =10V, I _D =4A	-	-	1.1	Ω
V _{GS(th)}	Gate Threshold Voltage	V _{DS} =V _{GS} , I _D =250uA	2	-	4	V
g _{fs}	Forward Transconductance	V _{DS} =10V, I _D =4A	-	8	-	S
I _{DSS}	Drain-Source Leakage Current	V _{DS} =480V, V _{GS} =0V	-	-	25	uA
	Drain-Source Leakage Current (T _j =125°C)	V _{DS} =480V, V _{GS} =0V	-	-	500	uA
I _{GSS}	Gate-Source Leakage	V _{GS} =±30V, V _{DS} =0V	-	-	±100	nA
Q _g	Total Gate Charge ³	I _D =7A	-	66	105	nC
Q _{gs}	Gate-Source Charge	V _{DS} =480V	-	10	-	nC
Q _{gd}	Gate-Drain ("Miller") Charge	V _{GS} =10V	-	24	-	nC
t _{d(on)}	Turn-on Delay Time ³	V _{DD} =300V	-	36	-	ns
t _r	Rise Time	I _D =7A	-	46	-	ns
t _{d(off)}	Turn-off Delay Time	R _G =50Ω, V _{GS} =10V	-	465	-	ns
t _f	Fall Time	R _D =42.8Ω	-	87	-	ns
C _{iss}	Input Capacitance	V _{GS} =0V	-	2730	4400	pF
C _{oss}	Output Capacitance	V _{DS} =15V	-	470	-	pF
C _{riss}	Reverse Transfer Capacitance	f=1.0MHz	-	60	-	pF

Source-Drain Diode

Symbol	Parameter	Test Conditions	Min.	Typ.	Max.	Units
V _{SD}	Forward On Voltage ³	I _S =7A, V _{GS} =0V	-	-	1.5	V
t _{rr}	Reverse Recovery Time ³	I _S =7A, V _{GS} =0V,	-	480	-	ns
Q _{rr}	Reverse Recovery Charge	dI/dt=100A/μs	-	7	-	μC

Notes:

- 1.Pulse width limited by max. junction temperature.
- 2.Starting T_j=25°C , V_{DD}=50V , L=1mH , R_G=25Ω
- 3.Pulse test

THIS PRODUCT IS SENSITIVE TO ELECTROSTATIC DISCHARGE, PLEASE HANDLE WITH CAUTION.

USE OF THIS PRODUCT AS A CRITICAL COMPONENT IN LIFE SUPPORT OR OTHER SIMILAR SYSTEMS IS NOT AUTHORIZED.

APEC DOES NOT ASSUME ANY LIABILITY ARISING OUT OF THE APPLICATION OR USE OF ANY PRODUCT OR CIRCUIT DESCRIBED HEREIN; NEITHER DOES IT CONVEY ANY LICENSE UNDER ITS PATENT RIGHTS, NOR THE RIGHTS OF OTHERS.

APEC RESERVES THE RIGHT TO MAKE CHANGES WITHOUT FURTHER NOTICE TO ANY PRODUCTS HEREIN TO IMPROVE RELIABILITY, FUNCTION OR DESIGN.

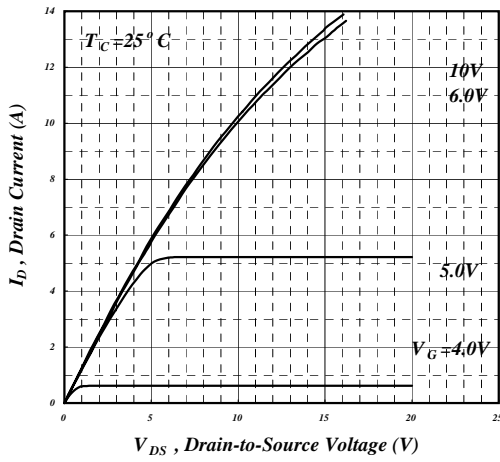

Fig 1. Typical Output Characteristics

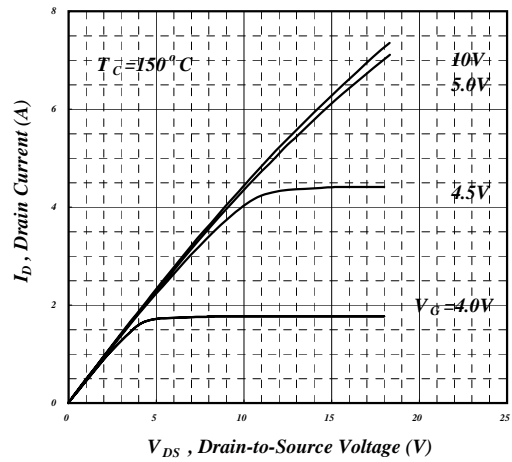

Fig 2. Typical Output Characteristics

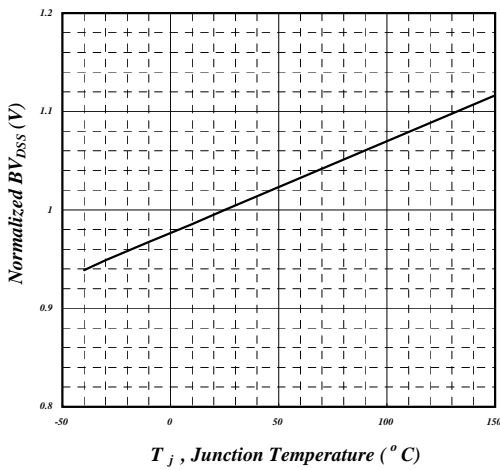

Fig 3. Normalized BV_{DSS} v.s. Junction Temperature

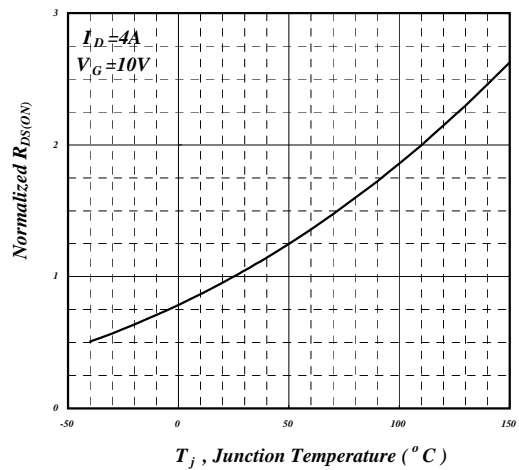

Fig 4. Normalized On-Resistance v.s. Junction Temperature

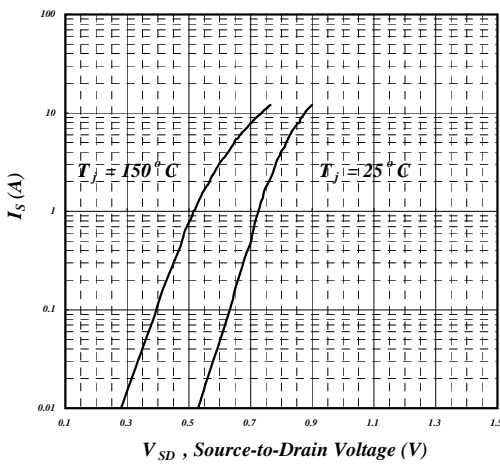

Fig 5. Forward Characteristic of Reverse Diode

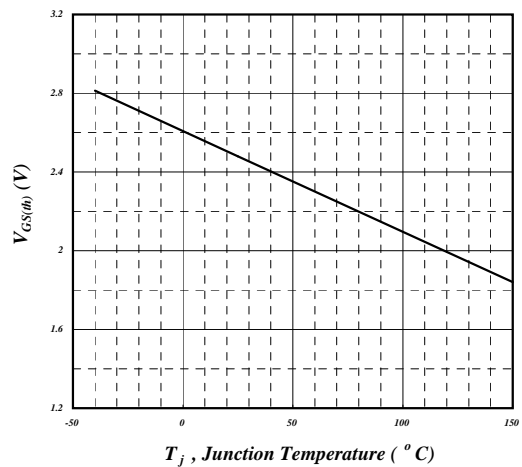

Fig 6. Gate Threshold Voltage v.s. Junction Temperature

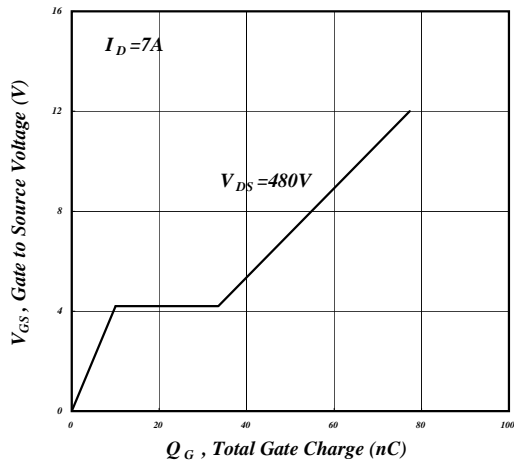

Fig 7. Gate Charge Characteristics

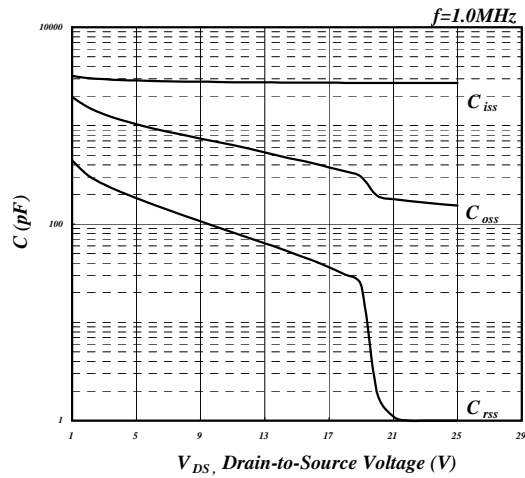

Fig 8. Typical Capacitance Characteristics

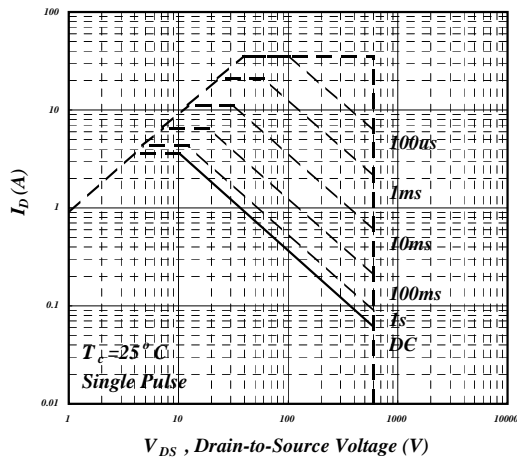

Fig 9. Maximum Safe Operating Area

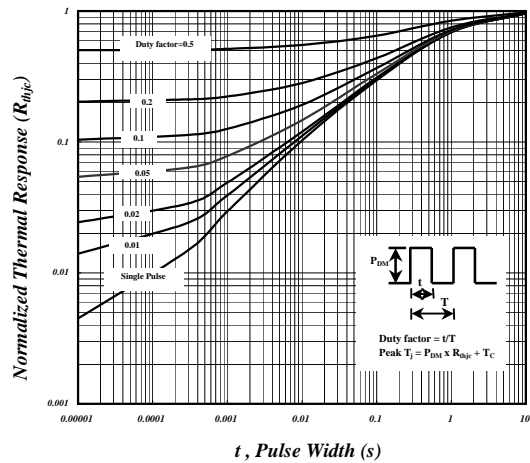

Fig 10. Effective Transient Thermal Impedance

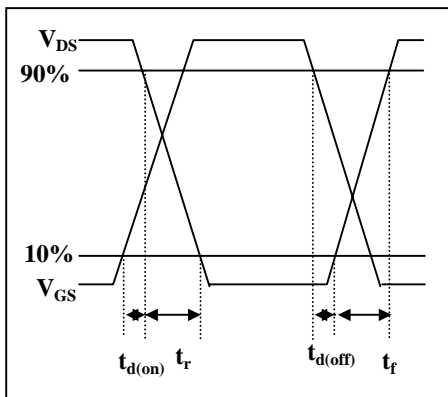

Fig 11. Switching Time Waveform

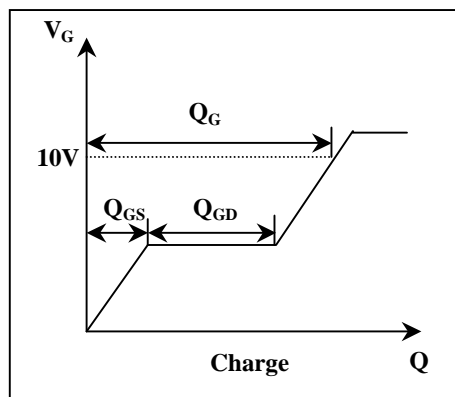
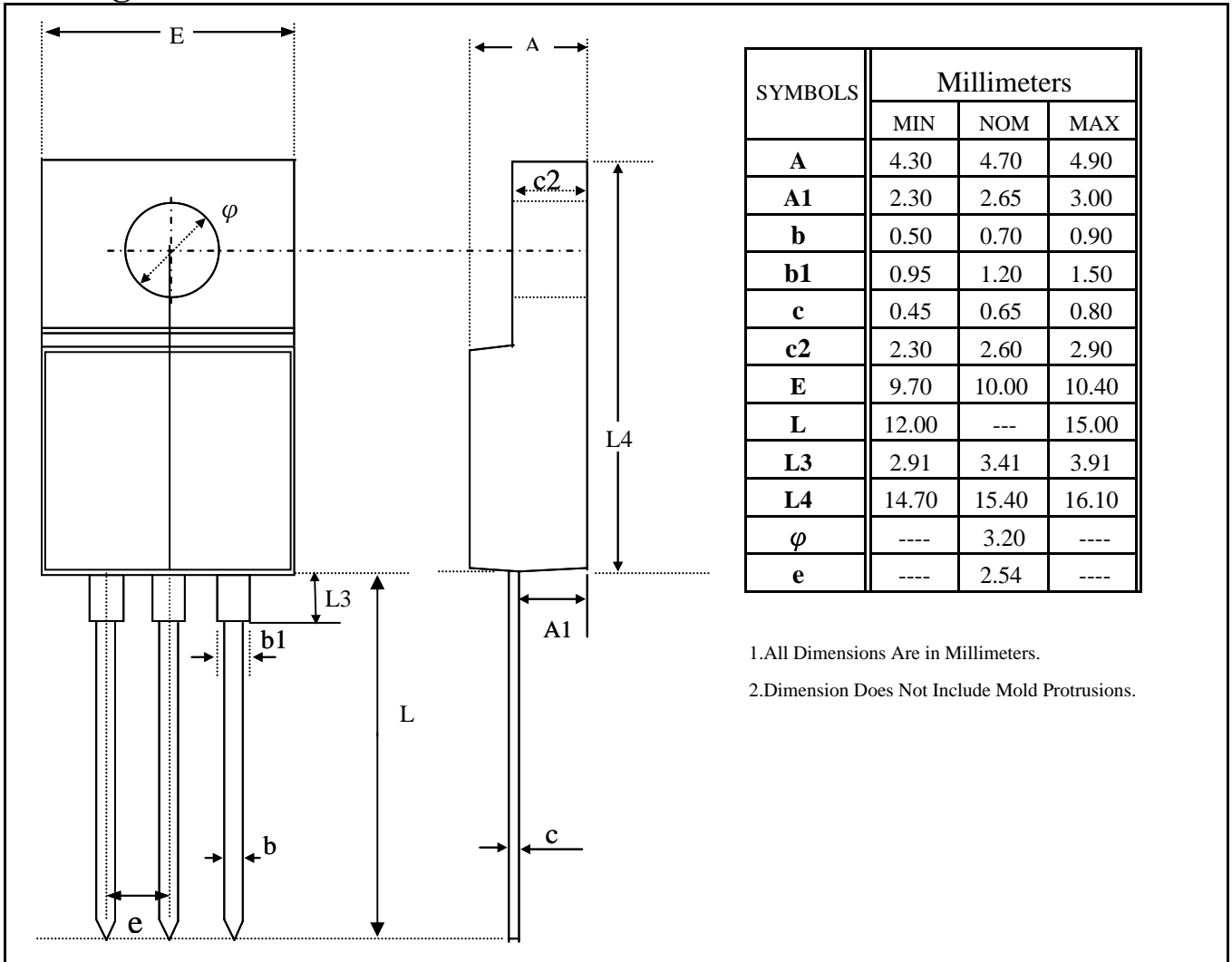

Fig 12. Gate Charge Waveform



ADVANCED POWER ELECTRONICS CORP.

Package Outline : TO-220CFM



Part Marking Information & Packing : TO-220CFM

