

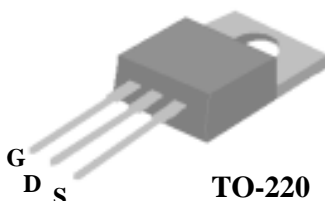

- ▼ Dynamic dv/dt Rating
- ▼ Repetitive Avalanche Rated
- ▼ Fast Switching
- ▼ Simple Drive Requirement



$BV_{DSS}$	400V
$R_{DS(ON)}$	1.0Ω
$I_D$	5.5A

## Description

The Advanced Power MOSFETs from APEC provide the designer with the best combination of fast switching , ruggedized device design , low on-resistance and cost-effectiveness.

The TO-220 package is universally preferred for all commercial-industrial applications. The device is suited for switch mode power supplies ,DC-AC converters and high current high speed switching circuits.

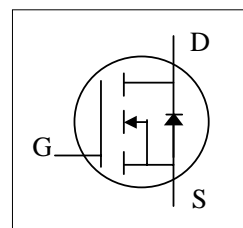

## Absolute Maximum Ratings

Symbol	Parameter	Rating	Units
$V_{DS}$	Drain-Source Voltage	400	V
$V_{GS}$	Gate-Source Voltage	± 30	V
$I_D @ T_C=25^{\circ}C$	Continuous Drain Current, $V_{GS}$ @ 10V	5.5	A
$I_D @ T_C=100^{\circ}C$	Continuous Drain Current, $V_{GS}$ @ 10V	3.5	A
$I_{DM}$	Pulsed Drain Current <sup>1</sup>	23	A
$P_D @ T_C=25^{\circ}C$	Total Power Dissipation	74	W
	Linear Derating Factor	0.59	W/°C
$E_{AS}$	Single Pulse Avalanche Energy <sup>2</sup>	260	mJ
$I_{AR}$	Avalanche Current	5.5	A
$E_{AR}$	Repetitive Avalanche Energy	7	mJ
$T_{STG}$	Storage Temperature Range	-55 to 150	°C
$T_J$	Operating Junction Temperature Range	-55 to 150	°C

## Thermal Data

Symbol	Parameter	Value	Unit
Rthj-c	Thermal Resistance Junction-case	Max. 1.7	°C/W
Rthj-a	Thermal Resistance Junction-ambient	Max. 62	°C/W

**Electrical Characteristics @ $T_j=25^\circ\text{C}$  (unless otherwise specified)**

Symbol	Parameter	Test Conditions	Min.	Typ.	Max.	Units
$BV_{DSS}$	Drain-Source Breakdown Voltage	$V_{GS}=0V, I_D=250\mu A$	400	-	-	V
$\Delta BV_{DSS}/\Delta T_j$	Breakdown Voltage Temperature Coefficient	Reference to $25^\circ\text{C}$ , $I_D=1\text{mA}$	-	0.36	-	$V/^\circ\text{C}$
$R_{DS(ON)}$	Static Drain-Source On-Resistance	$V_{GS}=10V, I_D=2.75A$	-	-	1	$\Omega$
$V_{GS(th)}$	Gate Threshold Voltage	$V_{DS}=V_{GS}, I_D=250\mu A$	2	-	4	V
$g_{fs}$	Forward Transconductance	$V_{DS}=10V, I_D=2.75A$	-	30	-	S
$I_{DSS}$	Drain-Source Leakage Current ( $T_j=25^\circ\text{C}$ )	$V_{DS}=400V, V_{GS}=0V$	-	-	10	$\mu A$
	Drain-Source Leakage Current ( $T_j=150^\circ\text{C}$ )	$V_{DS}=320V, V_{GS}=0V$	-	-	100	$\mu A$
$I_{GSS}$	Gate-Source Leakage	$V_{GS}=\pm 30V$	-	-	$\pm 100$	nA
$Q_g$	Total Gate Charge <sup>3</sup>	$I_D=5.5A$	-	35	-	nC
$Q_{gs}$	Gate-Source Charge	$V_{DS}=320V$	-	3.7	-	nC
$Q_{gd}$	Gate-Drain ("Miller") Charge	$V_{GS}=10V$	-	20	-	nC
$t_{d(on)}$	Turn-on Delay Time <sup>3</sup>	$V_{DD}=200V$	-	8	-	ns
$t_r$	Rise Time	$I_D=5.5A$	-	20	-	ns
$t_{d(off)}$	Turn-off Delay Time	$R_G=10\Omega, V_{GS}=10V$	-	47	-	ns
$t_f$	Fall Time	$R_D=36\Omega$	-	18	-	ns
$C_{iss}$	Input Capacitance	$V_{GS}=0V$	-	565	-	pF
$C_{oss}$	Output Capacitance	$V_{DS}=25V$	-	70	-	pF
$C_{rss}$	Reverse Transfer Capacitance	$f=1.0\text{MHz}$	-	38	-	pF

**Source-Drain Diode**

Symbol	Parameter	Test Conditions	Min.	Typ.	Max.	Units
$I_S$	Continuous Source Current ( Body Diode )	$V_D=V_G=0V, V_S=1.5V$	-	-	5.5	A
$I_{SM}$	Pulsed Source Current ( Body Diode ) <sup>1</sup>		-	-	23	A
$V_{SD}$	Forward On Voltage <sup>3</sup>	$T_j=25^\circ\text{C}, I_S=5.5A, V_{GS}=0V$	-	-	1.5	V

**Notes:**

1. Pulse width limited by safe operating area.
2. Starting  $T_j=25^\circ\text{C}$ ,  $V_{DD}=50V$ ,  $L=15\text{mH}$ ,  $R_G=25\Omega$ ,  $I_{AS}=5.5A$ .
3. Pulse width  $\leq 300\mu\text{s}$ , duty cycle  $\leq 2\%$ .

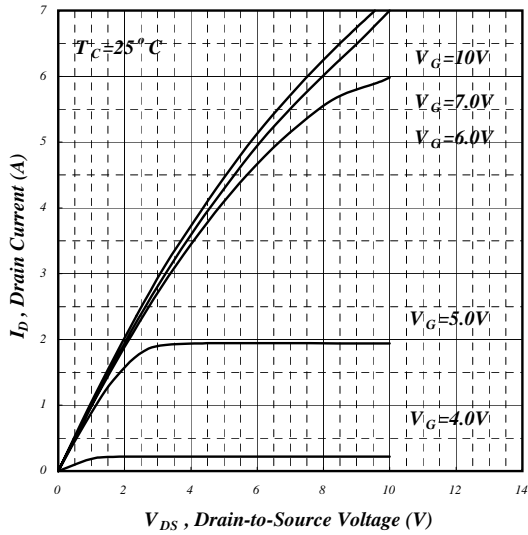

Fig 1. Typical Output Characteristics

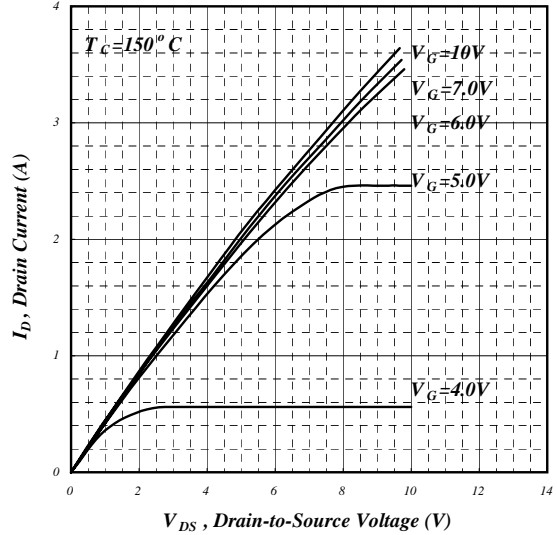

Fig 2. Typical Output Characteristics

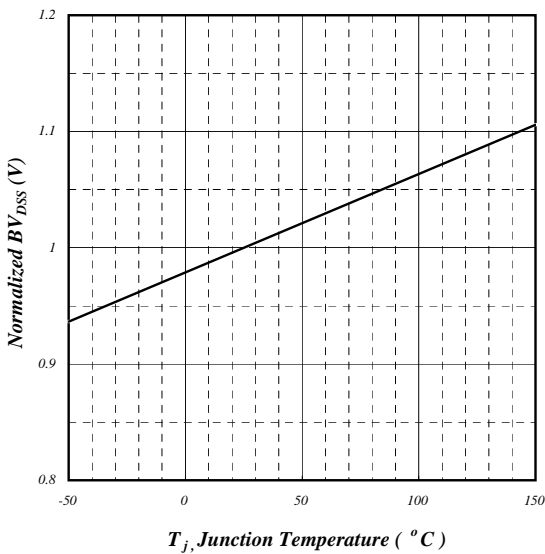

Fig 3. Normalized  $BV_{DSS}$  v.s. Junction Temperature

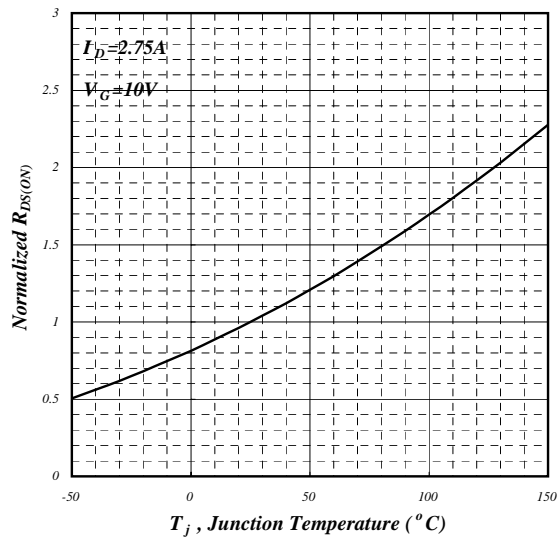

Fig 4. Normalized On-Resistance v.s. Junction Temperature

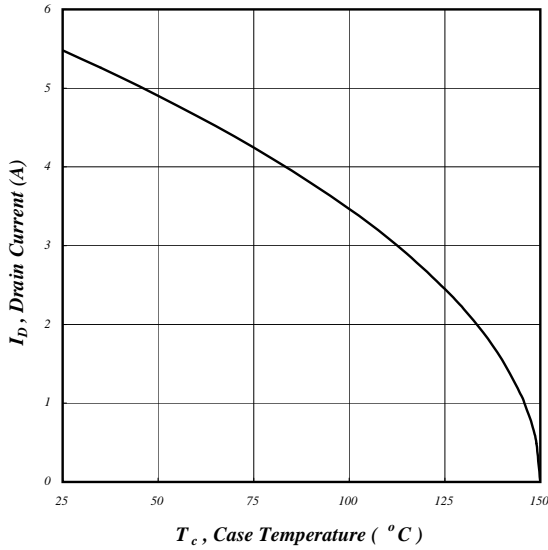

Fig 5. Maximum Drain Current v.s. Case Temperature

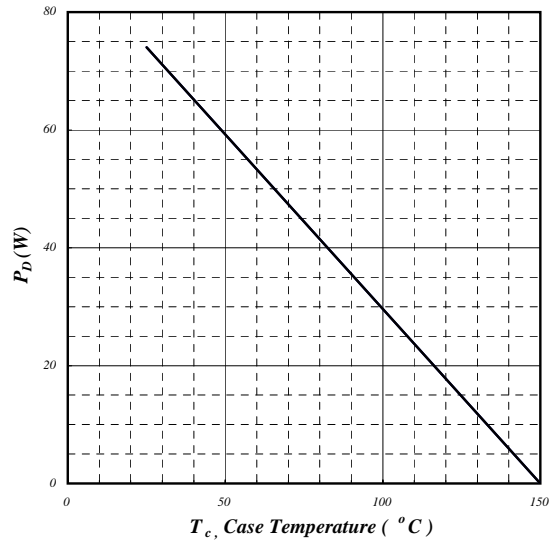

Fig 6. Typical Power Dissipation

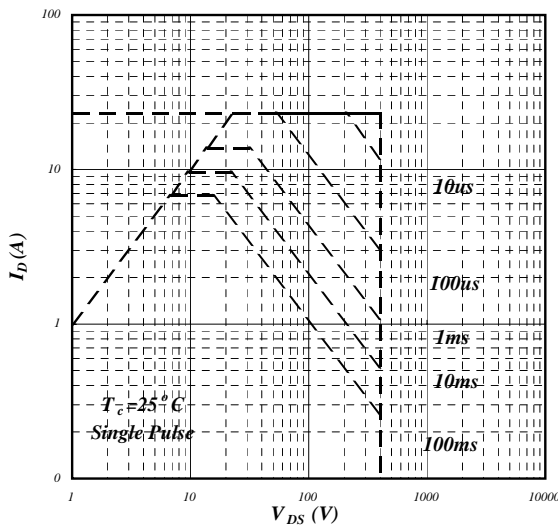

Fig 7. Maximum Safe Operating Area

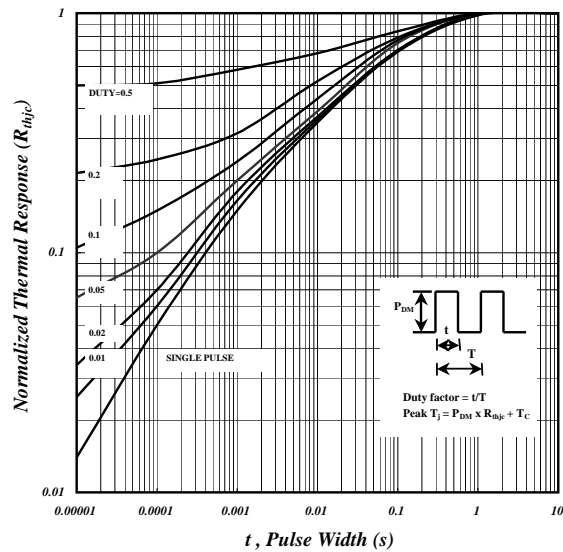

Fig 8. Effective Transient Thermal Impedance

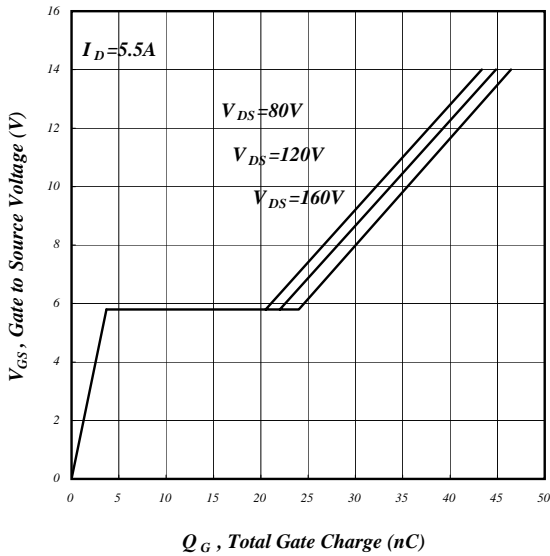

Fig 9. Gate Charge Characteristics

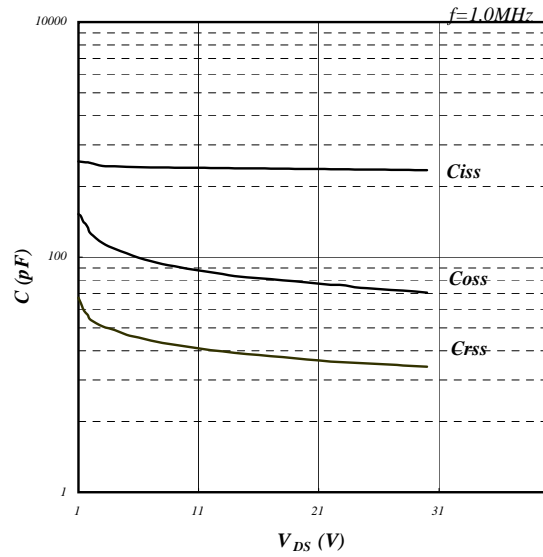

Fig 10. Typical Capacitance Characteristics

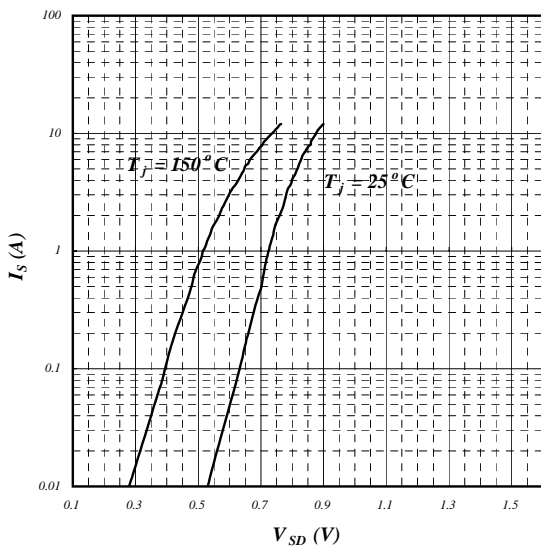

Fig 11. Forward Characteristic of Reverse Diode

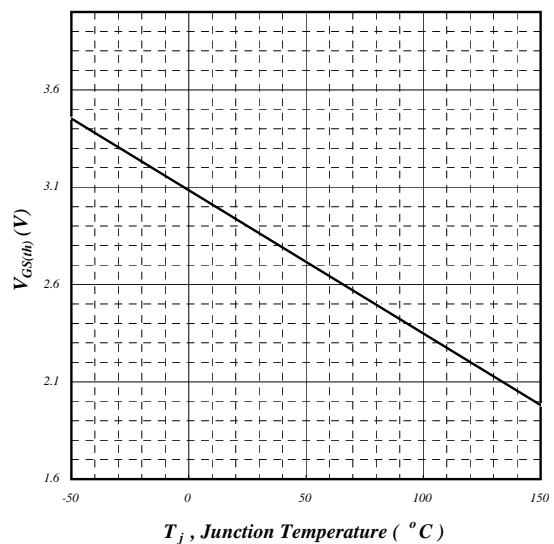

Fig 12. Gate Threshold Voltage v.s. Junction Temperature

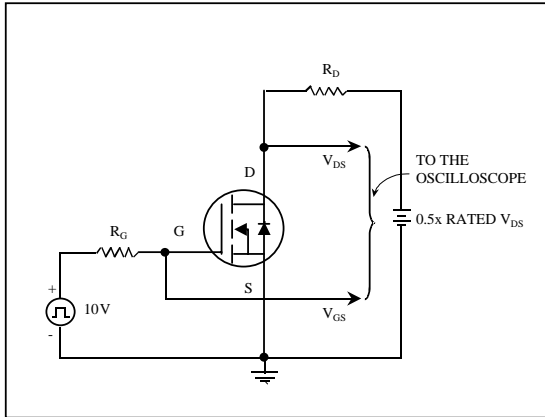

Fig 13. Switching Time Circuit

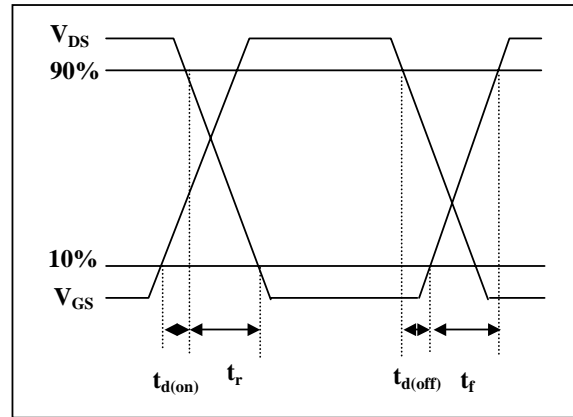

Fig 14. Switching Time Waveform

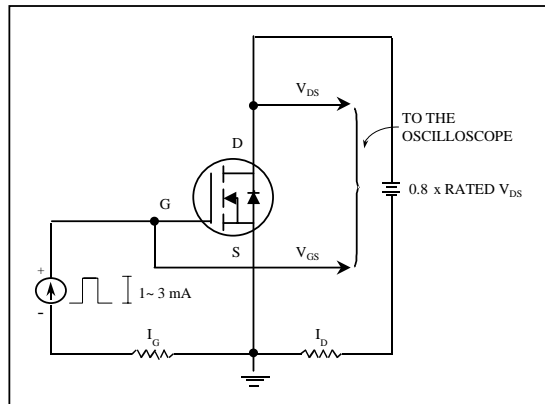

Fig 15. Gate Charge Circuit

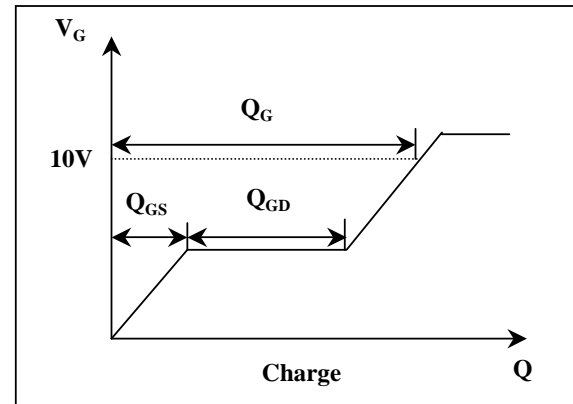

Fig 16. Gate Charge Waveform