

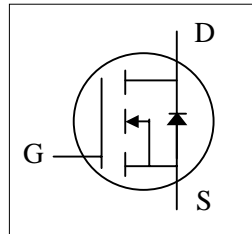

- ▼ Simple Drive Requirement
- ▼ Low On-resistance
- ▼ Fast Switching Characteristics
- ▼ RoHS Compliant



$BV_{DSS}$	200V
$R_{DS(ON)}$	380m $\Omega$
$I_D$	8.6A

## Description

Advanced Power MOSFETs from APEC provide the designer with the best combination of fast switching, ruggedized device design, low on-resistance and cost-effectiveness.

The TO-252 package is widely preferred for all commercial-industrial applications at power dissipation levels to approximately 50 watts. The through-hole version (AP09N20J) is available for low-profile applications.

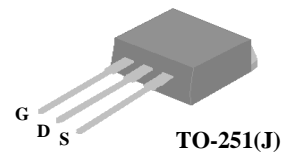
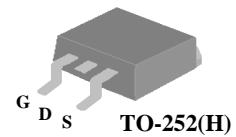

## Absolute Maximum Ratings

Symbol	Parameter	Rating	Units
$V_{DS}$	Drain-Source Voltage	200	V
$V_{GS}$	Gate-Source Voltage	+30	V
$I_D@T_C=25^\circ C$	Continuous Drain Current, $V_{GS}$ @ 10V	8.6	A
$I_D@T_C=100^\circ C$	Continuous Drain Current, $V_{GS}$ @ 10V	5.5	A
$I_{DM}$	Pulsed Drain Current <sup>1</sup>	36	A
$P_D@T_C=25^\circ C$	Total Power Dissipation	69	W
	Linear Derating Factor	0.55	W/ $^\circ C$
$E_{AS}$	Single Pulse Avalanche Energy <sup>2</sup>	40	mJ
$I_{AR}$	Avalanche Current	8.6	A
$T_{STG}$	Storage Temperature Range	-55 to 150	$^\circ C$
$T_J$	Operating Junction Temperature Range	-55 to 150	$^\circ C$

## Thermal Data

Symbol	Parameter	Value	Unit
Rthj-c	Maximum Thermal Resistance, Junction-case	1.8	$^\circ C/W$
Rthj-a	Maximum Thermal Resistance, Junction-ambient	110	$^\circ C/W$



# AP09N20H/J-HF

## Electrical Characteristics @T<sub>j</sub>=25°C(unless otherwise specified)

Symbol	Parameter	Test Conditions	Min.	Typ.	Max.	Units
BV <sub>DSS</sub>	Drain-Source Breakdown Voltage	V <sub>GS</sub> =0V, I <sub>D</sub> =1mA	200	-	-	V
ΔBV <sub>DSS</sub> /ΔT <sub>j</sub>	Breakdown Voltage Temperature Coefficient	Reference to 25°C, I <sub>D</sub> =1mA	-	0.24	-	V/°C
R <sub>DS(ON)</sub>	Static Drain-Source On-Resistance	V <sub>GS</sub> =10V, I <sub>D</sub> =5A	-	-	380	mΩ
V <sub>GS(th)</sub>	Gate Threshold Voltage	V <sub>DS</sub> =V <sub>GS</sub> , I <sub>D</sub> =250uA	2	-	4	V
g <sub>fs</sub>	Forward Transconductance	V <sub>DS</sub> =10V, I <sub>D</sub> =5A	-	3.7	-	S
I <sub>DSS</sub>	Drain-Source Leakage Current	V <sub>DS</sub> =200V, V <sub>GS</sub> =0V	-	-	10	uA
	Drain-Source Leakage Current (T <sub>j</sub> =150°C)	V <sub>DS</sub> =160V, V <sub>GS</sub> =0V	-	-	100	uA
I <sub>GSS</sub>	Gate-Source Leakage	V <sub>GS</sub> = ±30V	-	-	±100	nA
Q <sub>g</sub>	Total Gate Charge <sup>3</sup>	I <sub>D</sub> =8.6A	-	23	37	nC
Q <sub>gs</sub>	Gate-Source Charge	V <sub>DS</sub> =160V	-	4	-	nC
Q <sub>gd</sub>	Gate-Drain ("Miller") Charge	V <sub>GS</sub> =10V	-	13	-	nC
t <sub>d(on)</sub>	Turn-on Delay Time <sup>3</sup>	V <sub>DD</sub> =100V	-	12	-	ns
t <sub>r</sub>	Rise Time	I <sub>D</sub> =8.6A	-	25	-	ns
t <sub>d(off)</sub>	Turn-off Delay Time	R <sub>G</sub> =10Ω, V <sub>GS</sub> =10V	-	36	-	ns
t <sub>f</sub>	Fall Time	R <sub>D</sub> =11.6Ω	-	16	-	ns
C <sub>iss</sub>	Input Capacitance	V <sub>GS</sub> =0V	-	500	800	pF
C <sub>oss</sub>	Output Capacitance	V <sub>DS</sub> =25V	-	90	-	pF
C <sub>rss</sub>	Reverse Transfer Capacitance	f=1.0MHz	-	40	-	pF

## Source-Drain Diode

Symbol	Parameter	Test Conditions	Min.	Typ.	Max.	Units
V <sub>SD</sub>	Forward On Voltage <sup>3</sup>	I <sub>S</sub> =8.6A, V <sub>GS</sub> =0V	-	-	1.3	V
t <sub>rr</sub>	Reverse Recovery Time	I <sub>S</sub> =8.6A, V <sub>GS</sub> =0V,	-	225	-	ns
Q <sub>rr</sub>	Reverse Recovery Charge	di/dt=100A/μs	-	2260	-	nC

### Notes:

- 1.Pulse width limited by safe operating area.
- 2.Starting T<sub>j</sub>=25°C , V<sub>DD</sub>=50V , L=1mH , R<sub>G</sub>=25Ω , I<sub>AS</sub>=8.6A.
- 3.Pulse width ≤300us , duty cycle ≤2%.

THIS PRODUCT IS SENSITIVE TO ELECTROSTATIC DISCHARGE, PLEASE HANDLE WITH CAUTION.

USE OF THIS PRODUCT AS A CRITICAL COMPONENT IN LIFE SUPPORT OR OTHER SIMILAR SYSTEMS IS NOT AUTHORIZED.

APEC DOES NOT ASSUME ANY LIABILITY ARISING OUT OF THE APPLICATION OR USE OF ANY PRODUCT OR CIRCUIT DESCRIBED HEREIN; NEITHER DOES IT CONVEY ANY LICENSE UNDER ITS PATENT RIGHTS, NOR THE RIGHTS OF OTHERS.

APEC RESERVES THE RIGHT TO MAKE CHANGES WITHOUT FURTHER NOTICE TO ANY PRODUCTS HEREIN TO IMPROVE RELIABILITY, FUNCTION OR DESIGN.

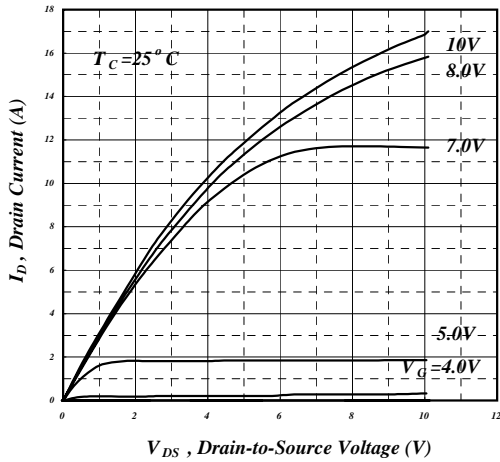

Fig 1. Typical Output Characteristics

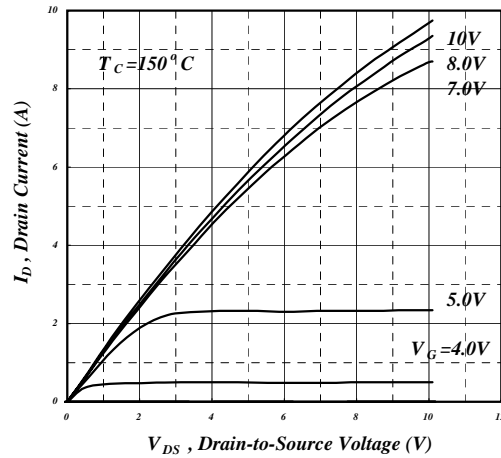

Fig 2. Typical Output Characteristics

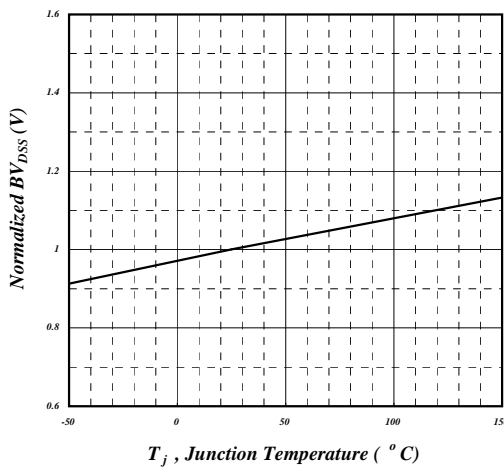

Fig 3. Normalized  $BV_{DSS}$  v.s. Junction Temperature

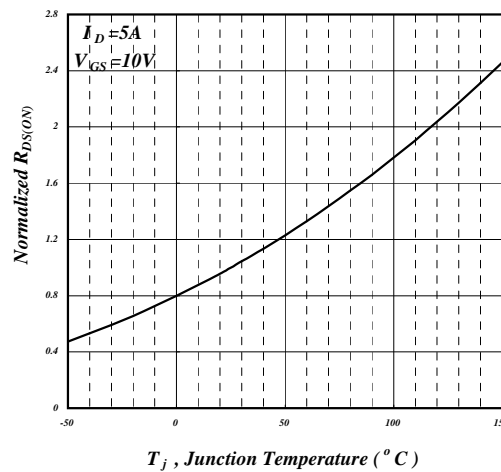

Fig 4. Normalized On-Resistance v.s. Junction Temperature

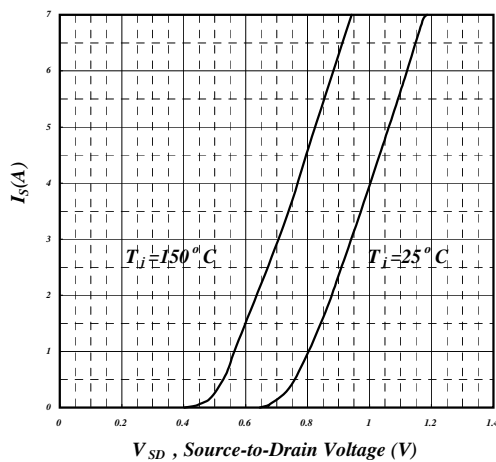

Fig 5. Forward Characteristic of Reverse Diode

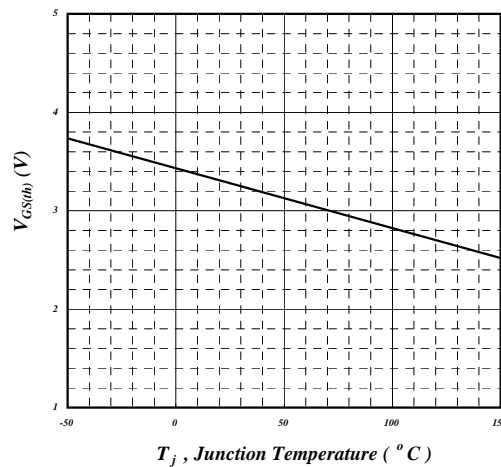

Fig 6. Gate Threshold Voltage v.s. Junction Temperature

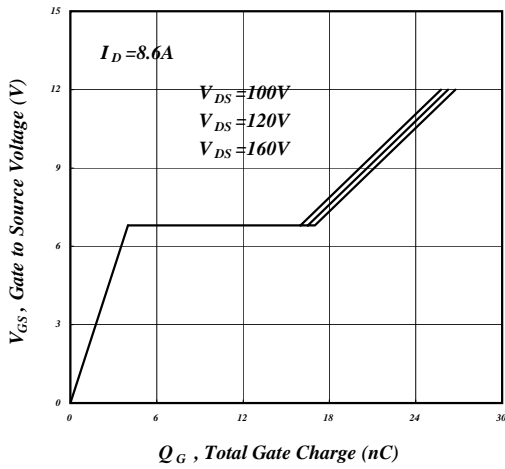

Fig 7. Gate Charge Characteristics

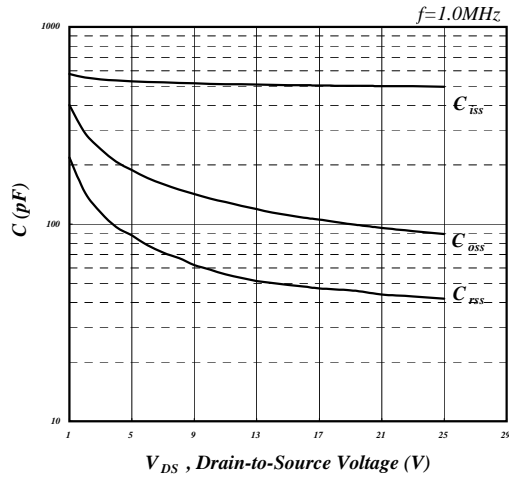

Fig 8. Typical Capacitance Characteristics

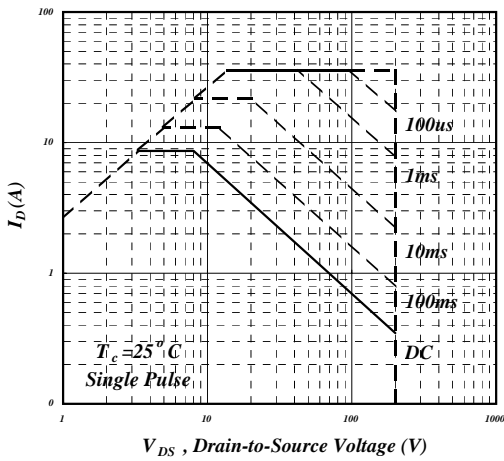

Fig 9. Maximum Safe Operating Area

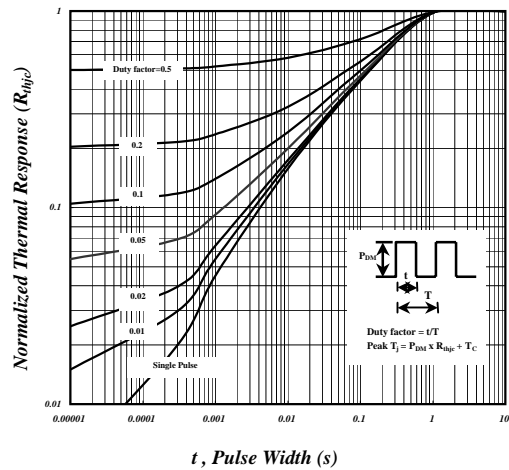

Fig 10. Effective Transient Thermal Impedance

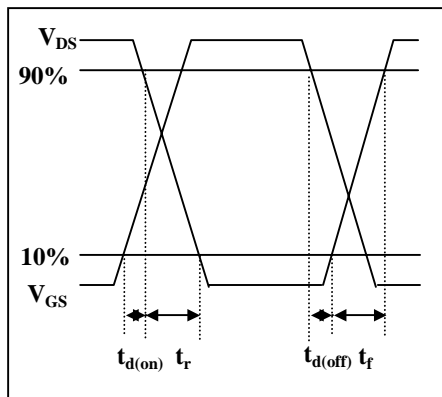

Fig 11. Switching Time Waveform

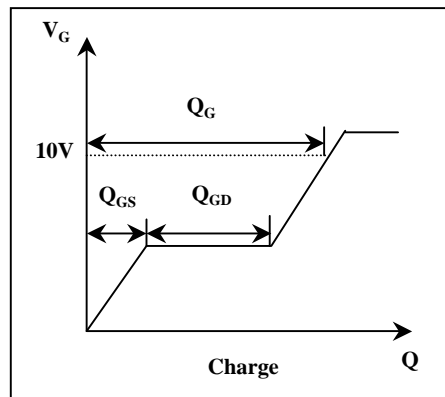
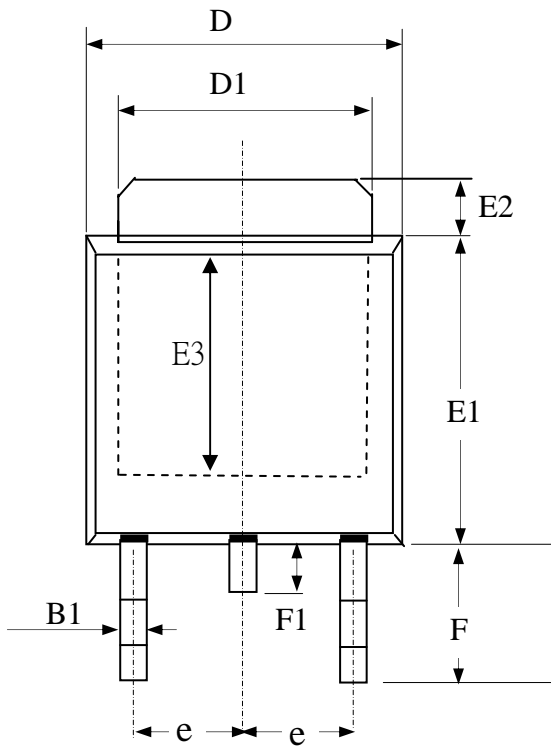

Fig 12. Gate Charge Waveform



**Package Outline : TO-252**



SYMBOLS	Millimeters		
	MIN	NOM	MAX
A2	1.80	2.30	2.80
A3	0.40	0.50	0.60
B1	0.40	0.70	1.00
D	6.00	6.50	7.00
D1	4.80	5.35	5.90
E3	3.50	4.00	4.50
F	2.20	2.63	3.05
F1	0.50	0.85	1.20
E1	5.10	5.70	6.30
E2	0.50	1.10	1.80
e	--	2.30	--
C	0.35	0.50	0.65

- 1.All Dimensions Are in Millimeters.
- 2.Dimension Does Not Include Mold Protrusions.

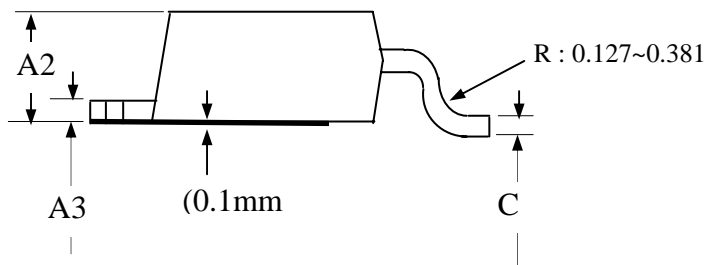

**Part Marking Information & Packing : TO-252**

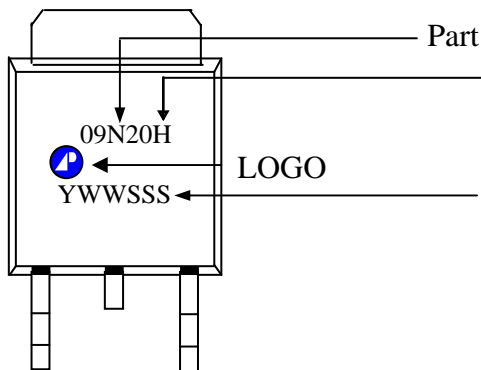

Part  
Package Code  
LOGO  
Date Code (YWWSSS)  
Y : Last Digit Of The Year  
WW : Week  
SSS : Sequence  
If last "S" is numerical letter : Rohs product  
If last "S" is English letter : HF & Rohs product



Package Outline : TO-251



Part Marking Information & Packing : TO-251

