

# AP9466GH/J

**RoHS-compliant Product**



**Advanced Power  
Electronics Corp.**

*N-CHANNEL ENHANCEMENT MODE*

*POWER MOSFET*

- ▼ Low On-resistance
- ▼ Single Drive Requirement
- ▼ Fast Switching Characteristics

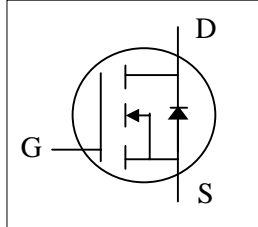

$BV_{DSS}$	40V
$R_{DS(ON)}$	13.5m $\Omega$
$I_D$	40A

## Description

Advanced Power MOSFETs from APEC provide the designer with the best combination of fast switching, ruggedized device design, low on-resistance and cost-effectiveness.

The TO-252 package is widely preferred for commercial-industrial surface mount applications and suited for low voltage applications such as DC/DC converters. The through-hole version (AP9466GJ) are available for low-profile applications.

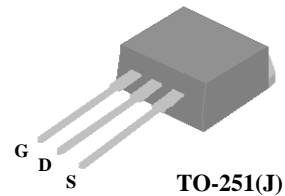
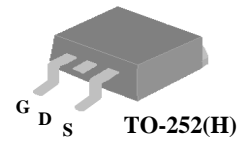

## Absolute Maximum Ratings

Symbol	Parameter	Rating	Units
$V_{DS}$	Drain-Source Voltage	40	V
$V_{GS}$	Gate-Source Voltage	$\pm 20$	V
$I_D@T_C=25^\circ C$	Continuous Drain Current, $V_{GS}$ @ 10V	40	A
$I_D@T_C=100^\circ C$	Continuous Drain Current, $V_{GS}$ @ 10V	25	A
$I_{DM}$	Pulsed Drain Current <sup>1</sup>	150	A
$P_D@T_C=25^\circ C$	Total Power Dissipation	36.7	W
	Linear Derating Factor	0.29	W/ $^\circ C$
$T_{STG}$	Storage Temperature Range	-55 to 150	$^\circ C$
$T_J$	Operating Junction Temperature Range	-55 to 150	$^\circ C$

## Thermal Data

Symbol	Parameter	Value	Unit
Rthj-c	Maximum Thermal Resistance, Junction-case	3.4	$^\circ C/W$
Rthj-a	Maximum Thermal Resistance, Junction-ambient	110	$^\circ C/W$



## Electrical Characteristics @ $T_j=25^{\circ}\text{C}$ (unless otherwise specified)

Symbol	Parameter	Test Conditions	Min.	Typ.	Max.	Units
$V_{DSS}$	Drain-Source Breakdown Voltage	$V_{GS}=0\text{V}, I_D=250\mu\text{A}$	40	-	-	V
$R_{DS(ON)}$	Static Drain-Source On-Resistance <sup>2</sup>	$V_{GS}=10\text{V}, I_D=26\text{A}$	-	-	13.5	m $\Omega$
		$V_{GS}=4.5\text{V}, I_D=16\text{A}$	-	-	21	m $\Omega$
$V_{GS(th)}$	Gate Threshold Voltage	$V_{DS}=V_{GS}, I_D=250\mu\text{A}$	1	-	3	V
$g_{fs}$	Forward Transconductance	$V_{DS}=10\text{V}, I_D=26\text{A}$	-	24.5	-	S
$I_{DSS}$	Drain-Source Leakage Current	$V_{DS}=40\text{V}, V_{GS}=0\text{V}$	-	-	1	$\mu\text{A}$
	Drain-Source Leakage Current ( $T_j=150^{\circ}\text{C}$ )	$V_{DS}=32\text{V}, V_{GS}=0\text{V}$	-	-	25	$\mu\text{A}$
$I_{GSS}$	Gate-Source Leakage	$V_{GS}=\pm 20\text{V}$	-	-	$\pm 100$	nA
$Q_g$	Total Gate Charge <sup>2</sup>	$I_D=26\text{A}$	-	13.5	22	nC
$Q_{gs}$	Gate-Source Charge	$V_{DS}=32\text{V}$	-	2.6	-	nC
$Q_{gd}$	Gate-Drain ("Miller") Charge	$V_{GS}=4.5\text{V}$	-	9.4	-	nC
$t_{d(on)}$	Turn-on Delay Time <sup>2</sup>	$V_{DS}=20\text{V}$	-	7	-	ns
$t_r$	Rise Time	$I_D=26\text{A}$	-	73	-	ns
$t_{d(off)}$	Turn-off Delay Time	$R_G=3.3\Omega, V_{GS}=10\text{V}$	-	20	-	ns
$t_f$	Fall Time	$R_D=0.77\Omega$	-	8	-	ns
$C_{iss}$	Input Capacitance	$V_{GS}=0\text{V}$	-	800	1280	pF
$C_{oss}$	Output Capacitance	$V_{DS}=25\text{V}$	-	170	-	pF
$C_{rss}$	Reverse Transfer Capacitance	$f=1.0\text{MHz}$	-	140	-	pF
$R_g$	Gate Resistance	$f=1.0\text{MHz}$	-	1.3	2	$\Omega$

## Source-Drain Diode

Symbol	Parameter	Test Conditions	Min.	Typ.	Max.	Units
$V_{SD}$	Forward On Voltage <sup>2</sup>	$I_S=26\text{A}, V_{GS}=0\text{V}$	-	-	1.2	V
$t_{rr}$	Reverse Recovery Time <sup>2</sup>	$I_S=20\text{A}, V_{GS}=0\text{V},$	-	27	-	ns
$Q_{rr}$	Reverse Recovery Charge	$dI/dt=100\text{A}/\mu\text{s}$	-	20	-	nC

### Notes:

1. Pulse width limited by Max. junction temperature.

2. Pulse test

THIS PRODUCT IS SENSITIVE TO ELECTROSTATIC DISCHARGE, PLEASE HANDLE WITH CAUTION.

USE OF THIS PRODUCT AS A CRITICAL COMPONENT IN LIFE SUPPORT OR OTHER SIMILAR SYSTEMS IS NOT AUTHORIZED.

APEC DOES NOT ASSUME ANY LIABILITY ARISING OUT OF THE APPLICATION OR USE OF ANY PRODUCT OR CIRCUIT DESCRIBED HEREIN; NEITHER DOES IT CONVEY ANY LICENSE UNDER ITS PATENT RIGHTS, NOR THE RIGHTS OF OTHERS.

APEC RESERVES THE RIGHT TO MAKE CHANGES WITHOUT FURTHER NOTICE TO ANY PRODUCTS HEREIN TO IMPROVE RELIABILITY, FUNCTION OR DESIGN.

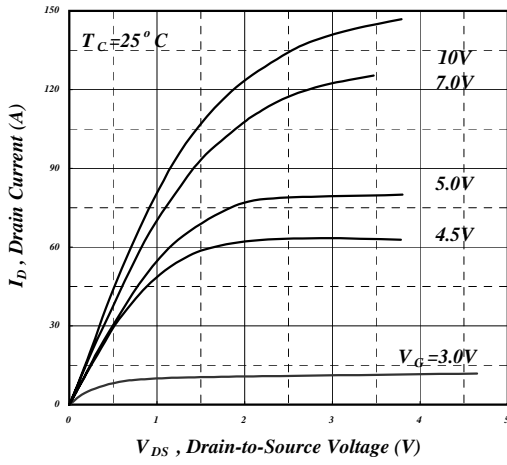

Fig 1. Typical Output Characteristics

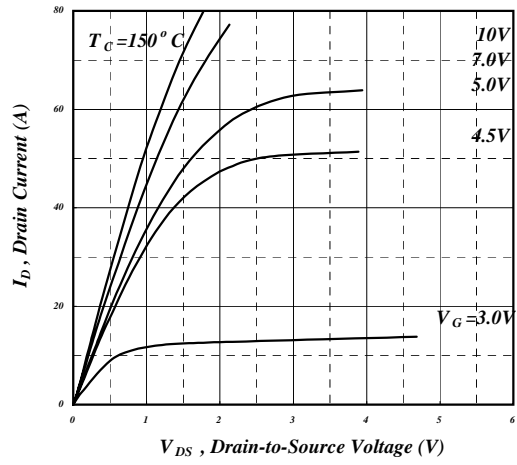

Fig 2. Typical Output Characteristics

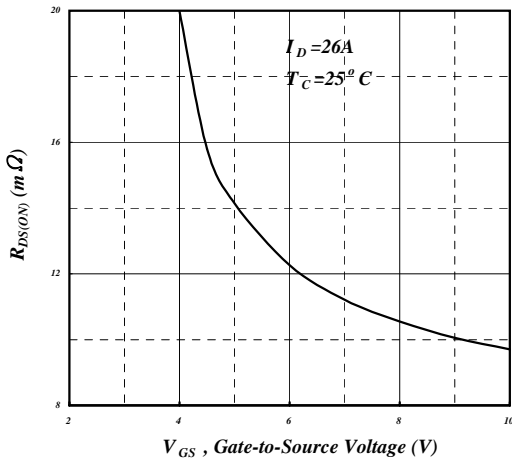

Fig 3. On-Resistance v.s. Gate Voltage

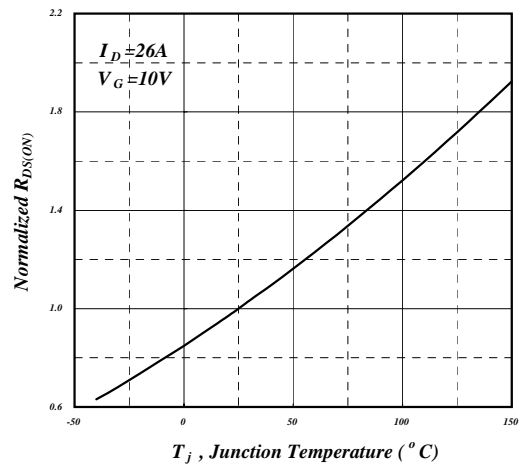

Fig 4. Normalized On-Resistance v.s. Junction Temperature

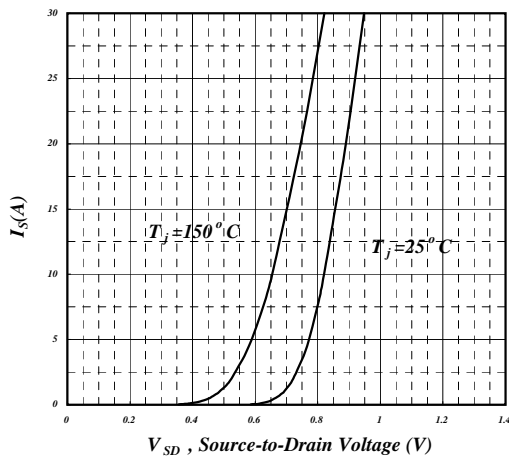

Fig 5. Forward Characteristic of Reverse Diode

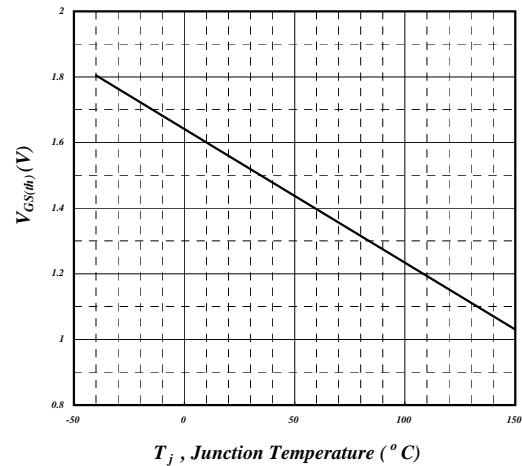

Fig 6. Gate Threshold Voltage v.s. Junction Temperature

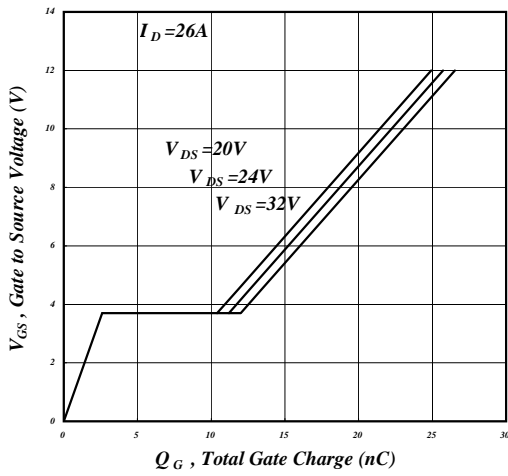

Fig 7. Gate Charge Characteristics

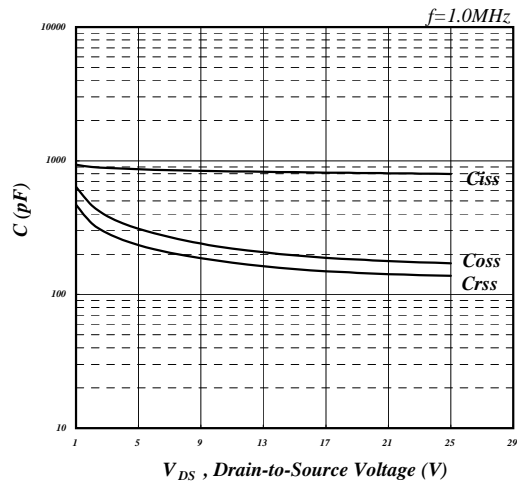

Fig 8. Typical Capacitance Characteristics

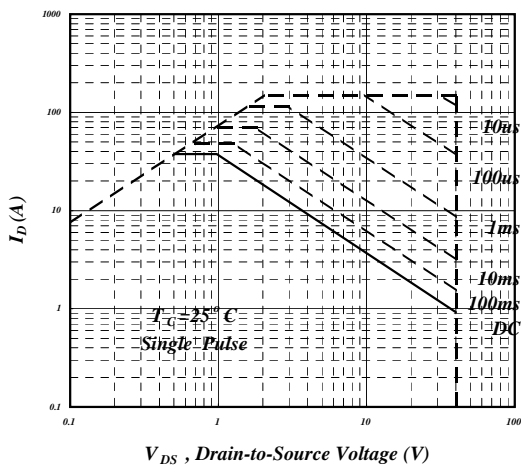

Fig 9. Maximum Safe Operating Area

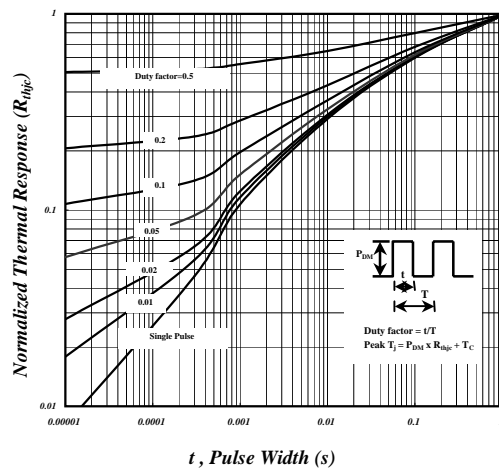

Fig 10. Effective Transient Thermal Impedance

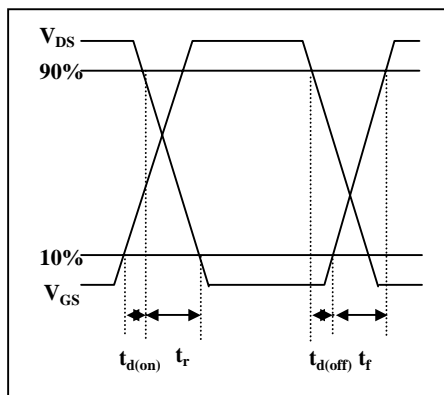

Fig 11. Switching Time Waveform

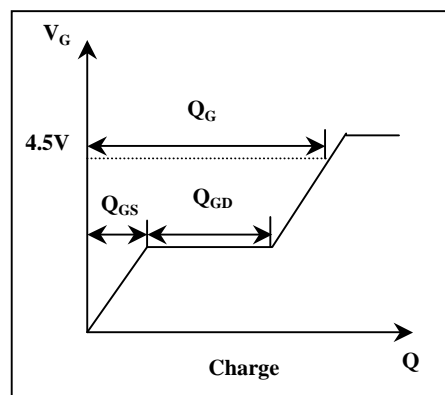
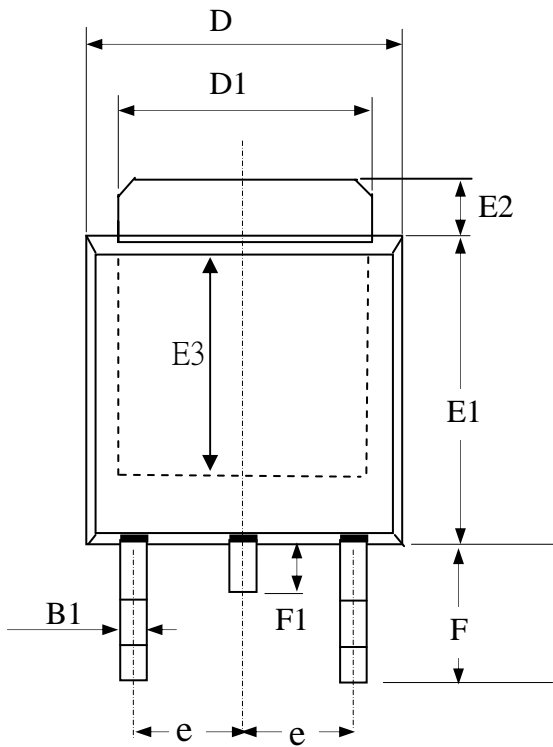

Fig 12. Gate Charge Waveform



Package Outline : TO-252



SYMBOLS	Millimeters		
	MIN	NOM	MAX
A2	1.80	2.30	2.80
A3	0.40	0.50	0.60
B1	0.40	0.70	1.00
D	6.00	6.50	7.00
D1	4.80	5.35	5.90
E3	3.50	4.00	4.50
F	2.20	2.63	3.05
F1	0.5	0.85	1.20
E1	5.10	5.70	6.30
E2	0.50	1.10	1.80
e	--	2.30	--
C	0.35	0.50	0.65

- 1.All Dimensions Are in Millimeters.
- 2.Dimension Does Not Include Mold Protrusions.

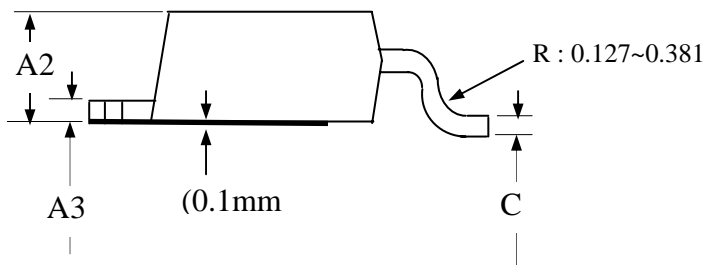

Part Marking Information & Packing : TO-252

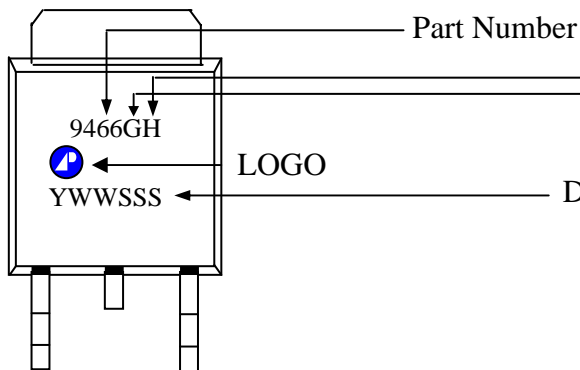

Part Number  
 Package Code  
 meet Rohs requirement  
 LOGO  
 Date Code (YWWSSS)  
 Y : Last Digit Of The Year  
 WW : Week  
 SSS : Sequence



Package Outline : TO-251

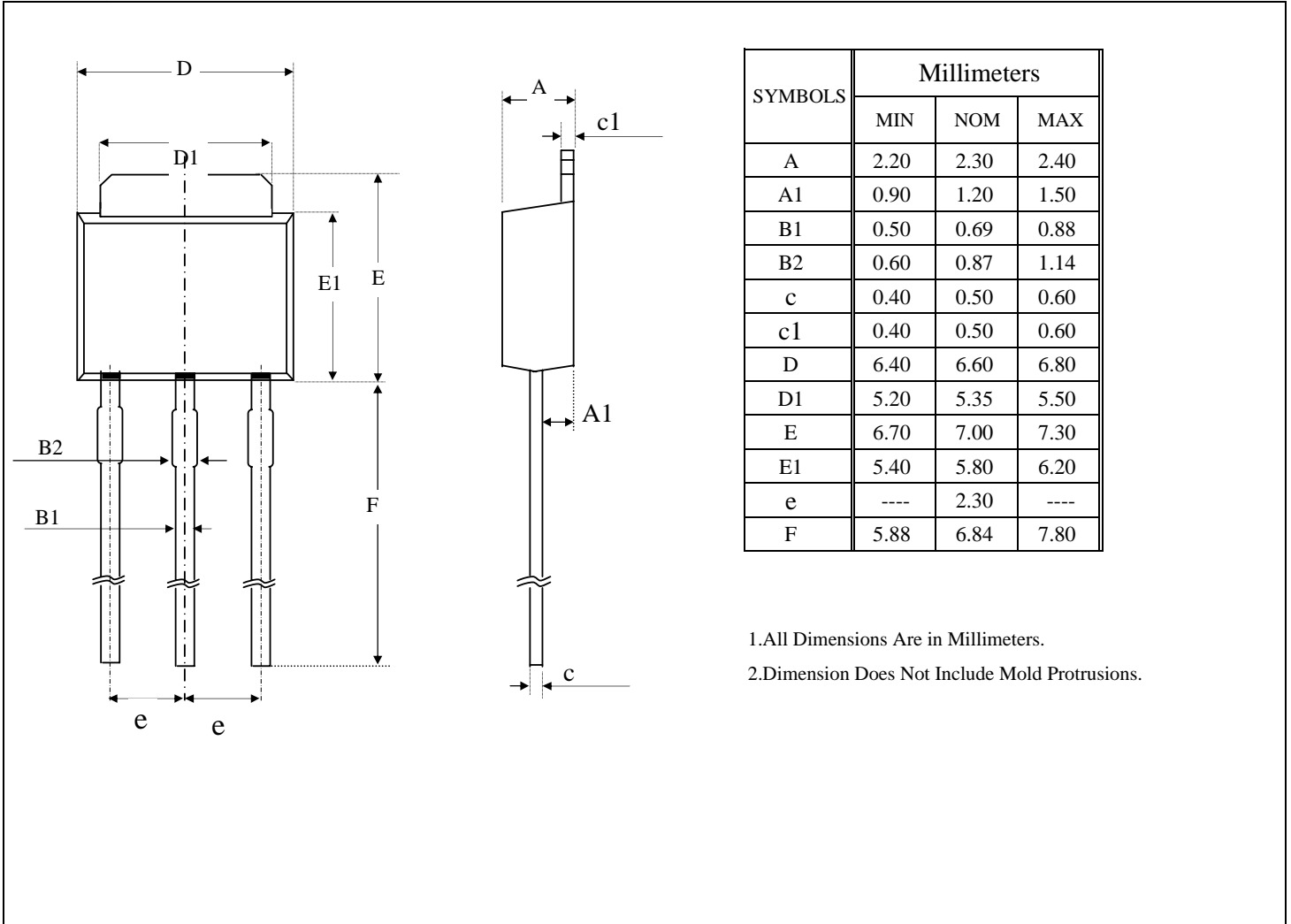

Part Marking Information & Packing : TO-251

