

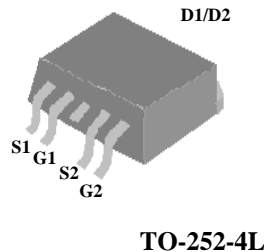

- ▼ Simple Drive Requirement
- ▼ Good Thermal Performance
- ▼ Fast Switching Performance



N-CH	BV_{DSS}	35V
	$R_{DS(ON)}$	27m Ω
	I_D	8.6A
P-CH	BV_{DSS}	-35V
	$R_{DS(ON)}$	45m Ω
	I_D	-6.7A

Description

The Advanced Power MOSFETs from APEC provide the designer with the best combination of fast switching, ruggedized device design, low on-resistance and cost-effectiveness.

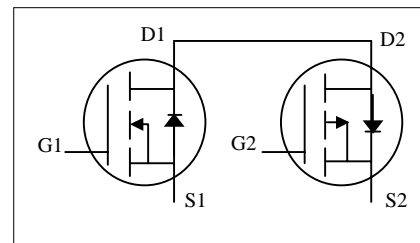

Absolute Maximum Ratings

Symbol	Parameter	Rating		Units
		N-channel	P-channel	
V_{DS}	Drain-Source Voltage	35	-35	V
V_{GS}	Gate-Source Voltage	± 20	± 20	V
$I_D @ T_A = 25^\circ C$	Continuous Drain Current ³	8.6	-6.7	A
$I_D @ T_A = 70^\circ C$	Continuous Drain Current ³	6.9	-5.4	A
I_{DM}	Pulsed Drain Current ¹	50	-50	A
$P_D @ T_A = 25^\circ C$	Total Power Dissipation	3.125		W
	Linear Derating Factor	0.025		W/ $^\circ C$
T_{STG}	Storage Temperature Range	-55 to 150		$^\circ C$
T_J	Operating Junction Temperature Range	-55 to 150		$^\circ C$

Thermal Data

Symbol	Parameter	Value	Units
Rthj-c	Thermal Resistance Junction-case	Max. 8	$^\circ C/W$
Rthj-a	Thermal Resistance Junction-ambient ³	Max. 40	$^\circ C/W$



AP4511GH-A

N-CH Electrical Characteristics @T_j=25°C(unless otherwise specified)

Symbol	Parameter	Test Conditions	Min.	Typ.	Max.	Units
BV _{DSS}	Drain-Source Breakdown Voltage	V _{GS} =0V, I _D =250uA	35	-	-	V
ΔBV _{DSS} /ΔT _j	Breakdown Voltage Temperature Coefficient	Reference to 25°C, I _D =1mA	-	0.02	-	V/°C
R _{DS(ON)}	Static Drain-Source On-Resistance ²	V _{GS} =10V, I _D =8A	-	-	27	mΩ
		V _{GS} =4.5V, I _D =5A	-	-	36	mΩ
V _{GS(th)}	Gate Threshold Voltage	V _{DS} =V _{GS} , I _D =250uA	0.8	-	2.5	V
g _{fs}	Forward Transconductance	V _{DS} =10V, I _D =8A	-	13	-	S
I _{DSS}	Drain-Source Leakage Current (T _j =25°C)	V _{DS} =35V, V _{GS} =0V	-	-	1	uA
	Drain-Source Leakage Current (T _j =150°C)	V _{DS} =28V, V _{GS} =0V	-	-	25	uA
I _{GSS}	Gate-Source Leakage	V _{GS} =±20V	-	-	±100	nA
Q _g	Total Gate Charge ²	I _D =8A	-	11	18	nC
Q _{gs}	Gate-Source Charge	V _{DS} =28V	-	3	-	nC
Q _{gd}	Gate-Drain ("Miller") Charge	V _{GS} =4.5V	-	6	-	nC
t _{d(on)}	Turn-on Delay Time ²	V _{DS} =18V	-	12	-	ns
t _r	Rise Time	I _D =1A	-	7	-	ns
t _{d(off)}	Turn-off Delay Time	R _G =3.3Ω, V _{GS} =10V	-	22	-	ns
t _f	Fall Time	R _D =18Ω	-	6	-	ns
C _{iss}	Input Capacitance	V _{GS} =0V	-	830	1330	pF
C _{oss}	Output Capacitance	V _{DS} =25V	-	150	-	pF
C _{rss}	Reverse Transfer Capacitance	f=1.0MHz	-	110	-	pF
R _g	Gate Resistance	f=1.0MHz	-	1.1	1.7	Ω

Source-Drain Diode

Symbol	Parameter	Test Conditions	Min.	Typ.	Max.	Units
V _{SD}	Forward On Voltage ²	I _S =8A, V _{GS} =0V	-	-	1.2	V
t _{rr}	Reverse Recovery Time ²	I _S =8A, V _{GS} =0V	-	18	-	ns
Q _{rr}	Reverse Recovery Charge	dI/dt=100A/μs	-	12	-	nC



P-CH Electrical Characteristics @T_j=25°C(unless otherwise specified)

Symbol	Parameter	Test Conditions	Min.	Typ.	Max.	Units
BV _{DSS}	Drain-Source Breakdown Voltage	V _{GS} =0V, I _D =-250uA	-35	-	-	V
ΔBV _{DSS} /ΔT _j	Breakdown Voltage Temperature Coefficient	Reference to 25°C, I _D =-1mA	-	-0.02	-	V/°C
R _{DS(ON)}	Static Drain-Source On-Resistance ²	V _{GS} =-10V, I _D =-6A	-	-	45	mΩ
		V _{GS} =-4.5V, I _D =-4A	-	-	70	mΩ
V _{GS(th)}	Gate Threshold Voltage	V _{DS} =V _{GS} , I _D =-250uA	-0.8	-	-2.5	V
g _{fs}	Forward Transconductance	V _{DS} =-10V, I _D =-6A	-	10	-	S
I _{DSS}	Drain-Source Leakage Current (T _j =25°C)	V _{DS} =-35V, V _{GS} =0V	-	-	-1	uA
		V _{DS} =-28V, V _{GS} =0V	-	-	-25	uA
I _{GSS}	Gate-Source Leakage	V _{GS} =±20V	-	-	±100	nA
Q _g	Total Gate Charge ²	I _D =-6A	-	10	19	nC
Q _{gs}	Gate-Source Charge	V _{DS} =-28V	-	2	-	nC
Q _{gd}	Gate-Drain ("Miller") Charge	V _{GS} =-4.5V	-	6	-	nC
t _{d(on)}	Turn-on Delay Time ²	V _{DS} =-18V	-	10	-	ns
t _r	Rise Time	I _D =-1A	-	6	-	ns
t _{d(off)}	Turn-off Delay Time	R _G =3.3Ω, V _{GS} =-10V	-	26	-	ns
t _f	Fall Time	R _D =18Ω	-	7	-	ns
C _{iss}	Input Capacitance	V _{GS} =0V	-	690	1100	pF
C _{oss}	Output Capacitance	V _{DS} =-25V	-	165	-	pF
C _{rss}	Reverse Transfer Capacitance	f=1.0MHz	-	130	-	pF
R _g	Gate Resistance	f=1.0MHz	-	5	7.5	Ω

Source-Drain Diode

Symbol	Parameter	Test Conditions	Min.	Typ.	Max.	Units
V _{SD}	Forward On Voltage ²	I _S =-6A, V _{GS} =0V	-	-	-1.2	V
t _{rr}	Reverse Recovery Time ²	I _S =-6A, V _{GS} =0V	-	20	-	ns
Q _{rr}	Reverse Recovery Charge	di/dt=-100A/μs	-	12	-	nC

Notes:

- 1.Pulse width limited by Max. junction temperature.
- 2.Pulse test
- 3.N-CH , P-CH are same , mounted on 2oz FR4 board t ≤ 10s.

THIS PRODUCT IS AN ELECTROSTATIC SENSITIVE, PLEASE HANDLE WITH CAUTION.

THIS PRODUCT HAS BEEN QUALIFIED FOR CONSUMER MARKET. APPLICATIONS OR USES AS CRITERIAL COMPONENT IN LIFE SUPPORT DEVICE OR SYSTEM ARE NOT AUTHORIZED.



N-Channel

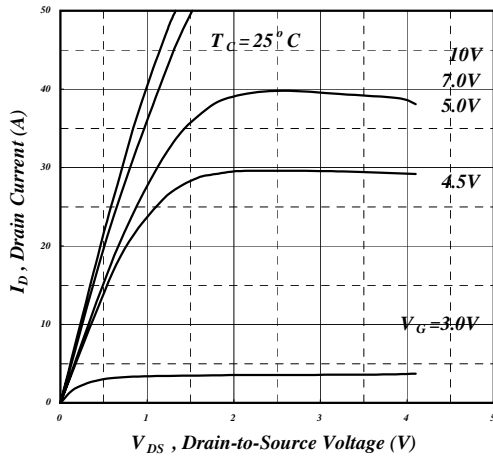

Fig 1. Typical Output Characteristics

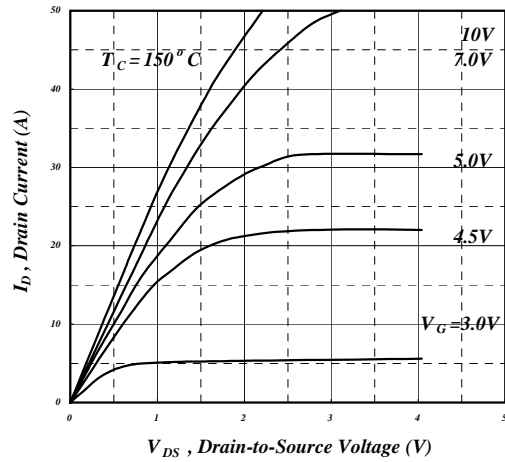

Fig 2. Typical Output Characteristics

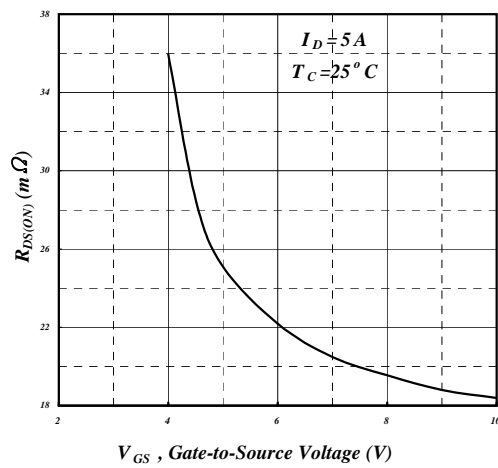

Fig 3. On-Resistance v.s. Gate Voltage

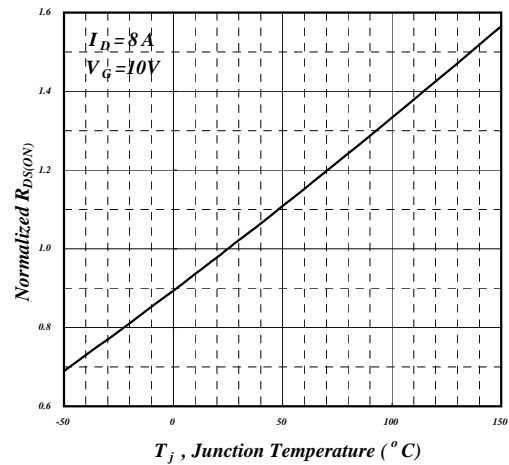

Fig 4. Normalized On-Resistance v.s. Junction Temperature

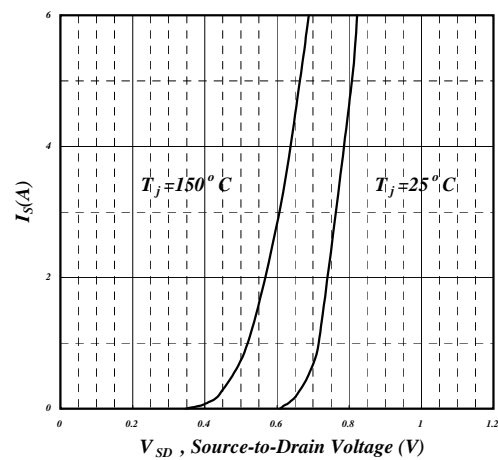

Fig 5. Forward Characteristic of Reverse Diode

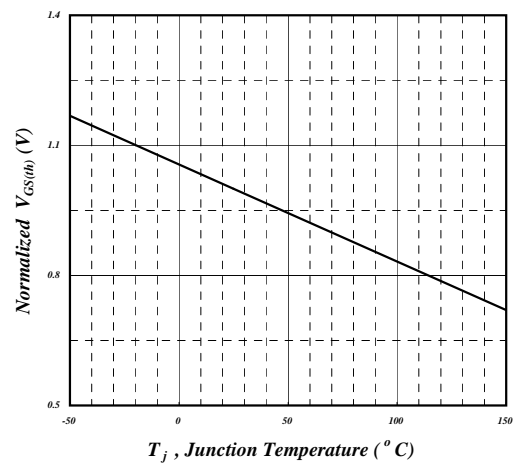

Fig 6. Gate Threshold Voltage v.s. Junction Temperature



N-Channel

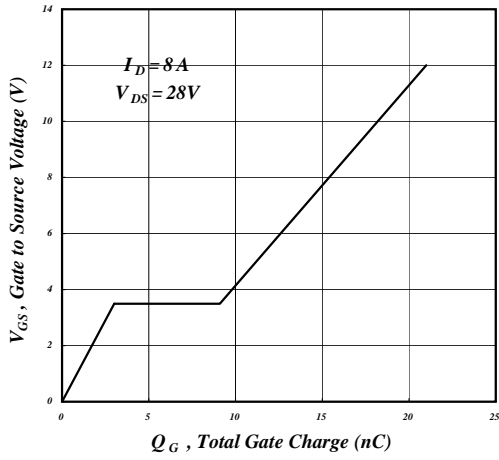

Fig 7. Gate Charge Characteristics

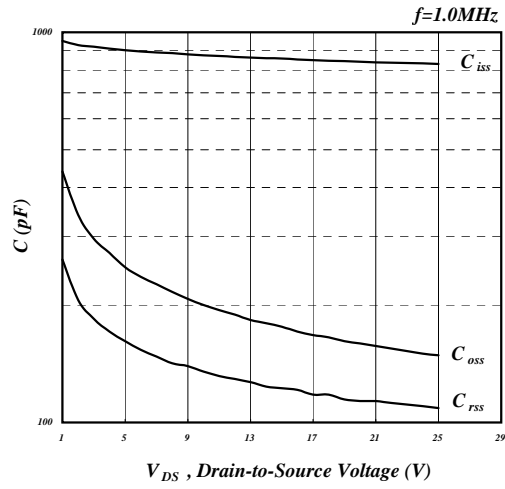

Fig 8. Typical Capacitance Characteristics

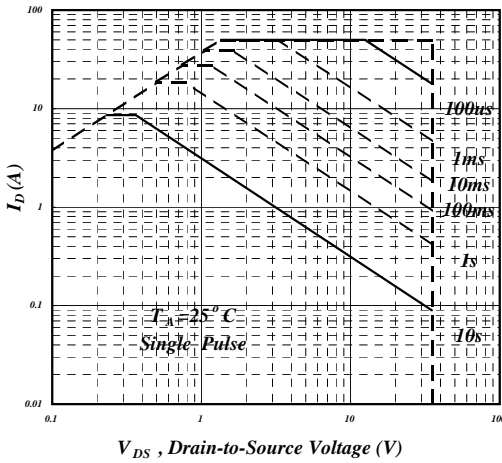

Fig 9. Maximum Safe Operating Area

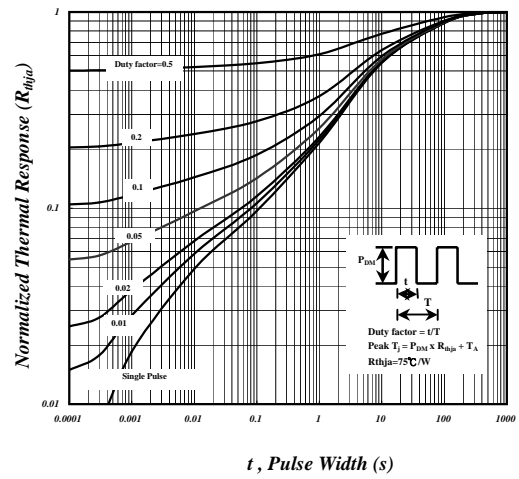

Fig 10. Effective Transient Thermal Impedance

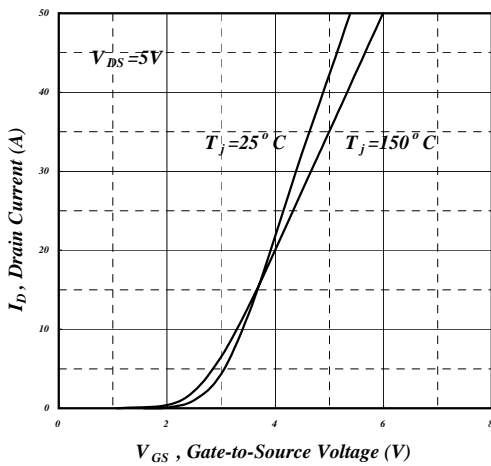

Fig 11. Transfer Characteristics

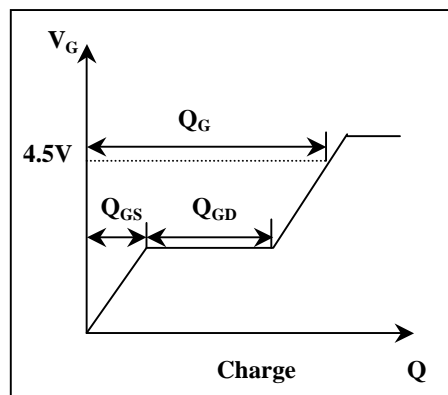

Fig 12. Gate Charge Waveform



AP4511GH-A

P-Channel

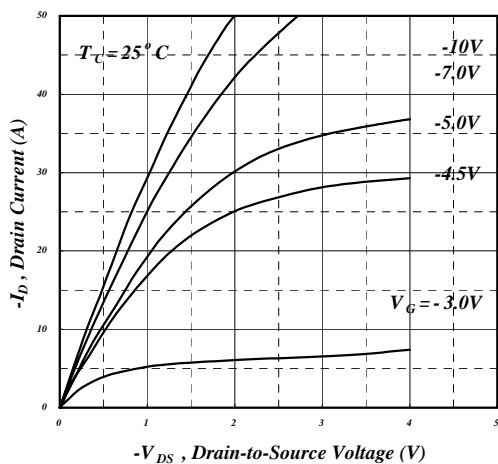

Fig 1. Typical Output Characteristics

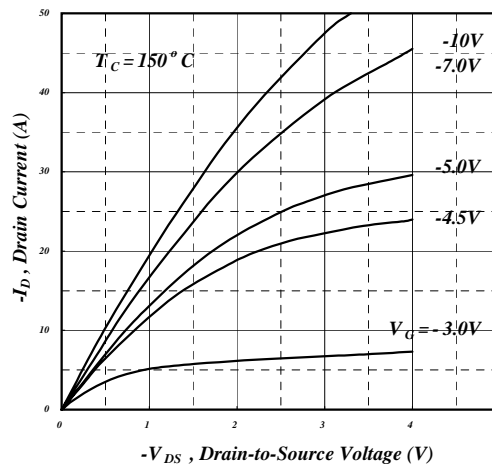

Fig 2. Typical Output Characteristics

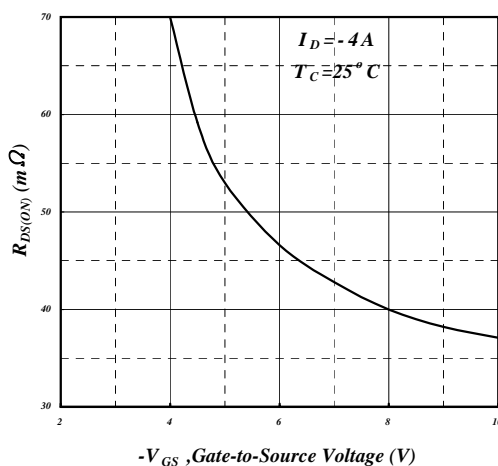

Fig 3. On-Resistance v.s. Gate Voltage

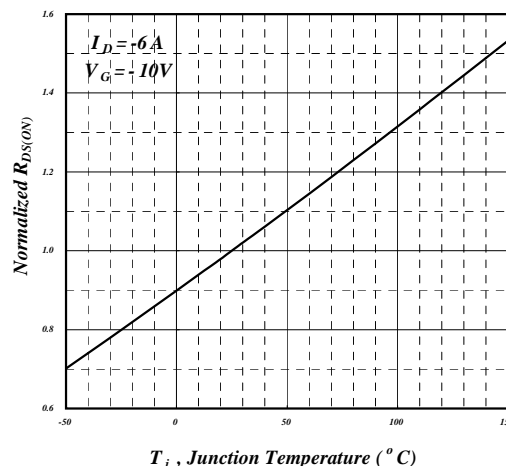

Fig 4. Normalized On-Resistance v.s. Junction Temperature

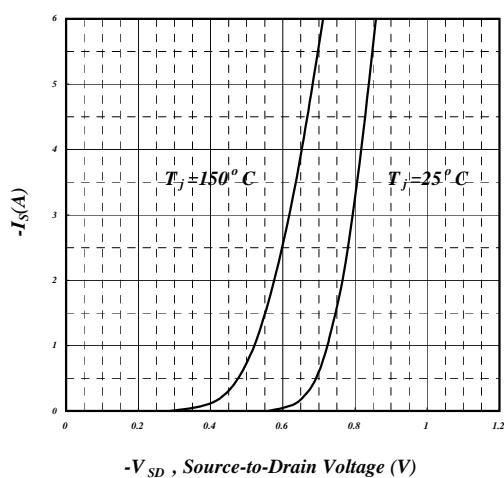

Fig 5. Forward Characteristic of Reverse Diode

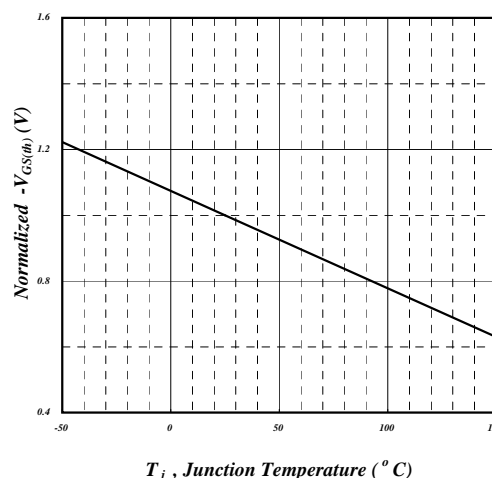

Fig 6. Gate Threshold Voltage v.s. Junction Temperature



P-Channel

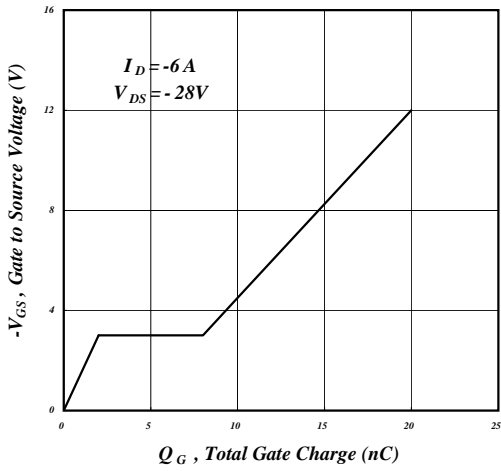

Fig 7. Gate Charge Characteristics

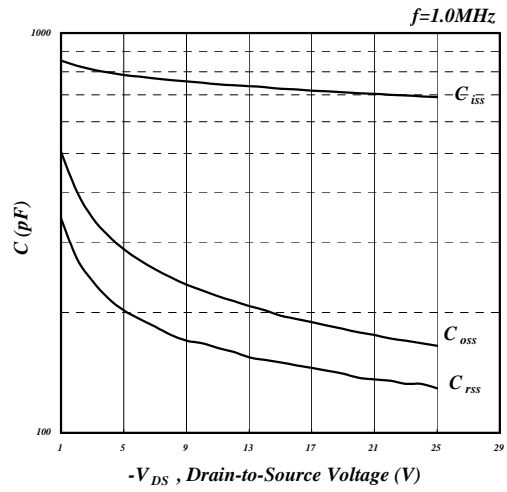

Fig 8. Typical Capacitance Characteristics

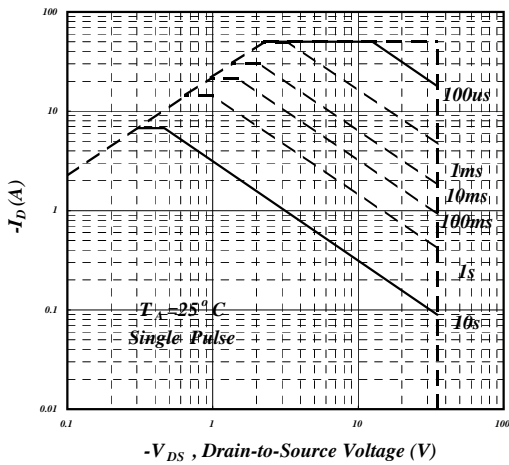

Fig 9. Maximum Safe Operating Area

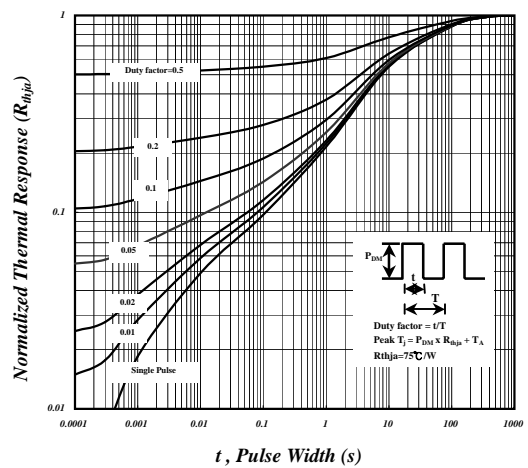

Fig 10. Effective Transient Thermal Impedance

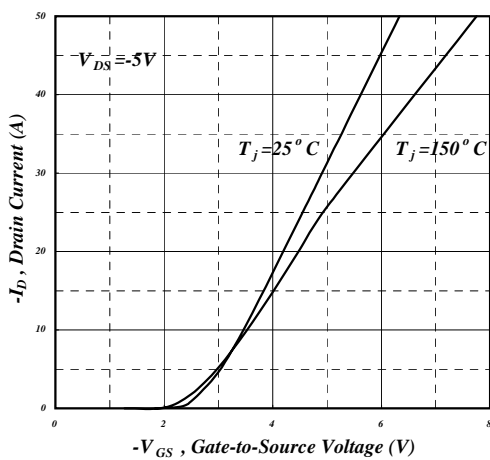

Fig 11. Transfer Characteristics

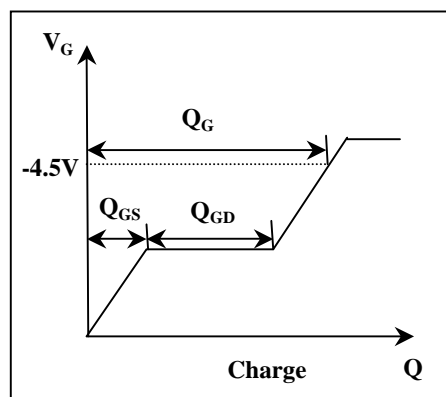
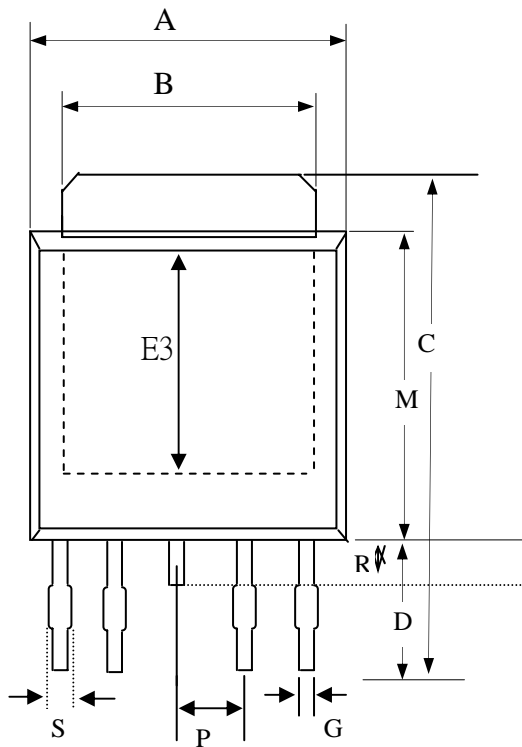

Fig 12. Gate Charge Waveform



Package Outline : TO-252(4L)



SYMBOLS	Millimeters		
	MIN	NOM	MAX
A	6.40	6.6	6.80
B	5.2	5.35	5.50
C	9.40	9.80	10.20
D	2.40	2.70	3.00
P	1.27 REF.		
S	0.50	0.65	0.80
E3	3.50	4.00	4.50
R	0.80	1.00	1.20
G	0.40	0.50	0.60
H	2.20	2.30	2.40
J	0.45	0.50	0.55
K	0.00	0.075	0.15
L	0.90	1.20	1.50
M	5.40	5.60	5.80

1.All Dimensions Are in Millimeters.

2.Dimension Does Not Include Mold Protrusions.

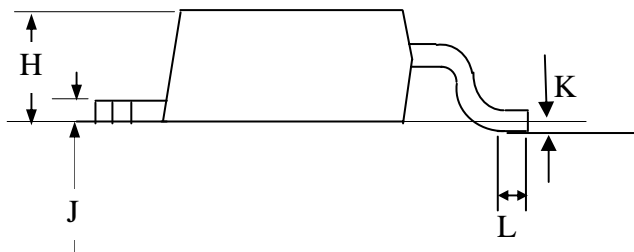

Part Marking Information & Packing : TO-252(4L)

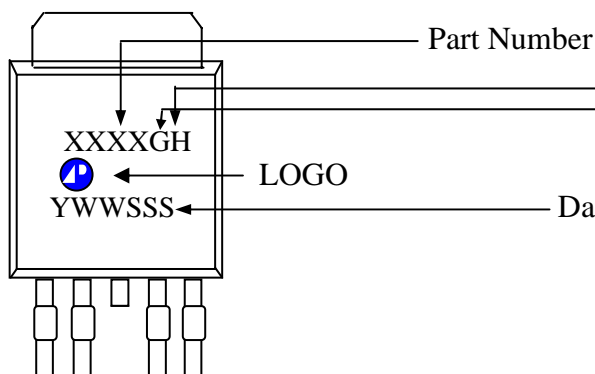

Package Code
meet Rohs requirement

Date Code (YWWSSS)

Y : Last Digit Of The Year

WW : Week

SSS : Sequence