

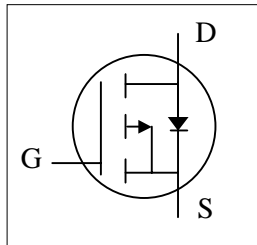

- ▼ Low Gate Charge
- ▼ Single Drive Requirement
- ▼ Lower On-resistance
- ▼ RoHS Compliant



BV_{DSS}	-30V
$R_{DS(ON)}$	9mΩ
I_D	-48A

Description

Advanced Power MOSFETs from APEC provide the designer with the best combination of fast switching, ruggedized device design, low on-resistance and cost-effectiveness.

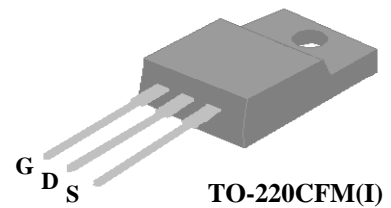

The TO-220CFM isolation package is widely preferred for all commercial-industrial through hole applications.

Absolute Maximum Ratings

Symbol	Parameter	Rating	Units
V_{DS}	Drain-Source Voltage	-30	V
V_{GS}	Gate-Source Voltage	+25	V
$I_D@T_C=25^\circ C$	Continuous Drain Current, V_{GS} @ 10V	-48	A
$I_D@T_C=100^\circ C$	Continuous Drain Current, V_{GS} @ 10V	-30	A
I_{DM}	Pulsed Drain Current ¹	300	A
$P_D@T_C=25^\circ C$	Total Power Dissipation	31.3	W
	Linear Derating Factor	0.25	W/°C
T_{STG}	Storage Temperature Range	-55 to 150	°C
T_J	Operating Junction Temperature Range	-55 to 150	°C

Thermal Data

Symbol	Parameter	Value	Units
Rthj-c	Maximum Thermal Resistance, Junction-case	4	°C/W
Rthj-a	Maximum Thermal Resistance, Junction-ambient	65	°C/W



AP6679GI-HF

Electrical Characteristics @ $T_j=25^\circ\text{C}$ (unless otherwise specified)

Symbol	Parameter	Test Conditions	Min.	Typ.	Max.	Units
BV_{DSS}	Drain-Source Breakdown Voltage	$V_{GS}=0V, I_D=-250\mu A$	-30	-	-	V
$\Delta BV_{DSS}/\Delta T_j$	Breakdown Voltage Temperature Coefficient	Reference to 25°C , $I_D=-1mA$	-	-0.02	-	V/ $^\circ\text{C}$
$R_{DS(ON)}$	Static Drain-Source On-Resistance ²	$V_{GS}=-10V, I_D=-30A$	-	-	9	m Ω
		$V_{GS}=-4.5V, I_D=-24A$	-	-	15	m Ω
$V_{GS(th)}$	Gate Threshold Voltage	$V_{DS}=V_{GS}, I_D=-250\mu A$	-1	-	-3	V
g_{fs}	Forward Transconductance	$V_{DS}=-10V, I_D=-30A$	-	43	-	S
I_{DSS}	Drain-Source Leakage Current	$V_{DS}=-30V, V_{GS}=0V$	-	-	-1	μA
	Drain-Source Leakage Current ($T_j=125^\circ\text{C}$)	$V_{DS}=-24V, V_{GS}=0V$	-	-	-250	μA
I_{GSS}	Halogen-Free	$V_{GS}=\pm 25, V_{DS}=0V$	-	-	± 100	nA
Q_g	Total Gate Charge ²	$I_D=-30A$	-	40	67	nC
Q_{gs}	Gate-Source Charge	$V_{DS}=-25V$	-	8	-	nC
Q_{gd}	Gate-Drain ("Miller") Charge	$V_{GS}=-4.5V$	-	28	-	nC
$t_{d(on)}$	Turn-on Delay Time ²	$V_{DS}=-15V$	-	15	-	ns
t_r	Rise Time	$I_D=-30A$	-	75	-	ns
$t_{d(off)}$	Turn-off Delay Time	$R_G=3.3\Omega, V_{GS}=-10V$	-	50	-	ns
t_f	Fall Time	$R_D=0.5\Omega$	-	90	-	ns
C_{iss}	Input Capacitance	$V_{GS}=0V$	-	3100	4590	pF
C_{oss}	Output Capacitance	$V_{DS}=-25V$	-	930	-	pF
C_{rss}	Reverse Transfer Capacitance	$f=1.0MHz$	-	690	-	pF
R_g	Gate Resistance	$f=1.0MHz$	-	2.7	4	Ω

Source-Drain Diode

Symbol	Parameter	Test Conditions	Min.	Typ.	Max.	Units
V_{SD}	Forward On Voltage ²	$I_S=-30A, V_{GS}=0V$	-	-	-1.3	V
t_{rr}	Reverse Recovery Time ²	$I_S=-24A, V_{GS}=0V,$	-	47	-	ns
Q_{rr}	Reverse Recovery Charge	$di/dt=-100A/\mu s$	-	45	-	nC

Notes:

1. Pulse width limited Max. junction temperature.
2. Pulse test

THIS PRODUCT IS SENSITIVE TO ELECTROSTATIC DISCHARGE, PLEASE HANDLE WITH CAUTION.

USE OF THIS PRODUCT AS A CRITICAL COMPONENT IN LIFE SUPPORT OR OTHER SIMILAR SYSTEMS IS NOT AUTHORIZED.

APEC DOES NOT ASSUME ANY LIABILITY ARISING OUT OF THE APPLICATION OR USE OF ANY PRODUCT OR CIRCUIT DESCRIBED HEREIN; NEITHER DOES IT CONVEY ANY LICENSE UNDER ITS PATENT RIGHTS, NOR THE RIGHTS OF OTHERS.

APEC RESERVES THE RIGHT TO MAKE CHANGES WITHOUT FURTHER NOTICE TO ANY PRODUCTS HEREIN TO IMPROVE RELIABILITY, FUNCTION OR DESIGN.

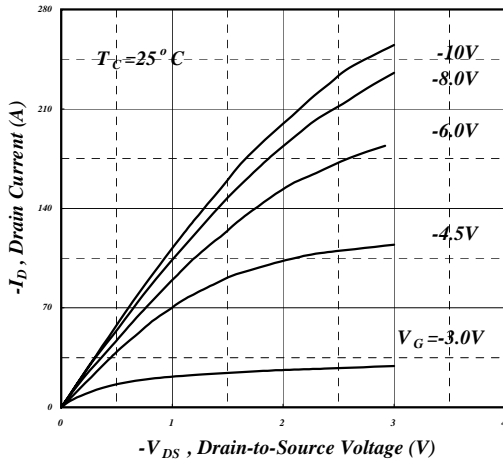

Fig 1. Typical Output Characteristics

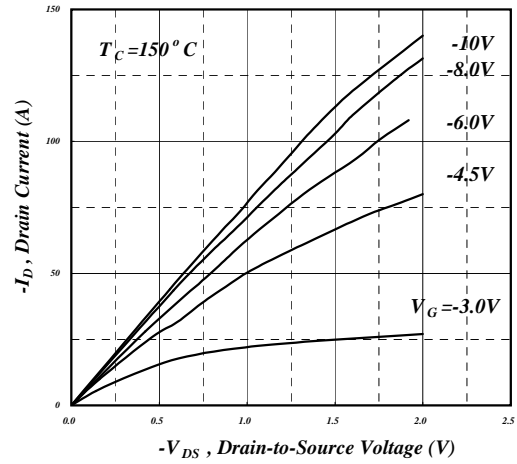

Fig 2. Typical Output Characteristics

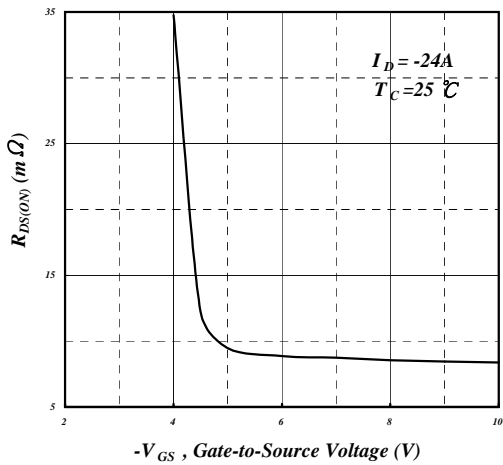

Fig 3. On-Resistance v.s. Gate Voltage

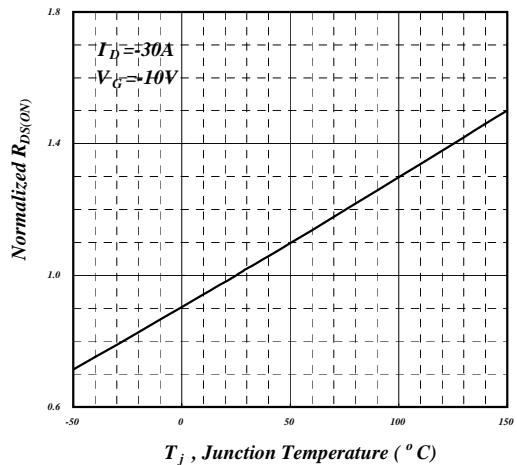

Fig 4. Normalized On-Resistance v.s. Junction Temperature

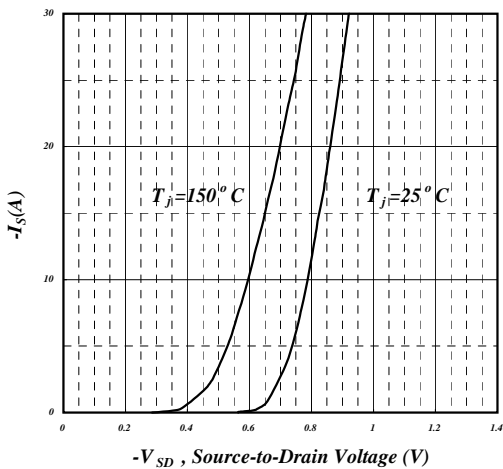

Fig 5. Forward Characteristic of Reverse Diode

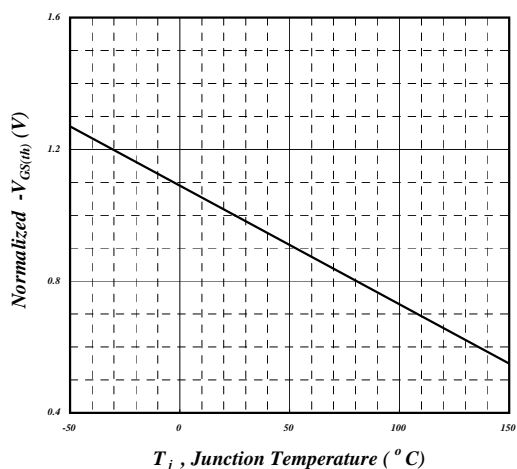

Fig 6. Gate Threshold Voltage v.s. Junction Temperature

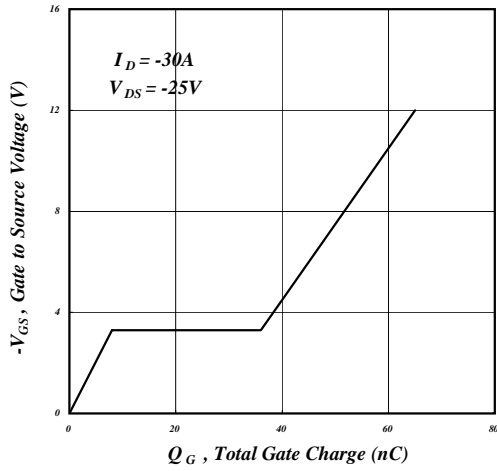

Fig 7. Gate Charge Characteristics

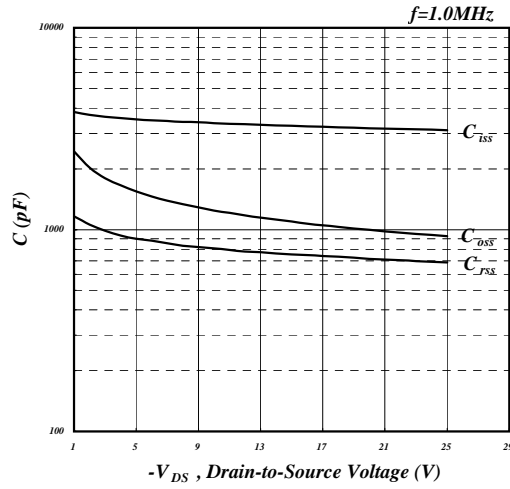

Fig 8. Typical Capacitance Characteristics

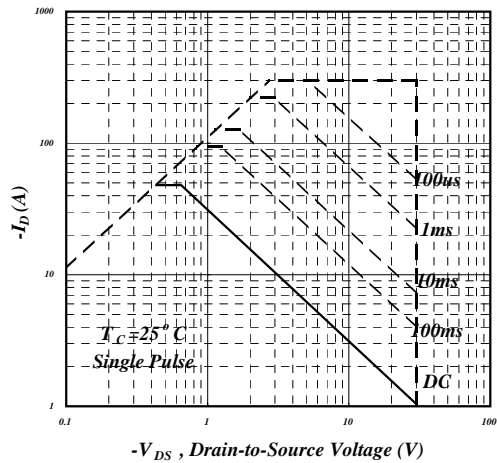

Fig 9. Maximum Safe Operating Area

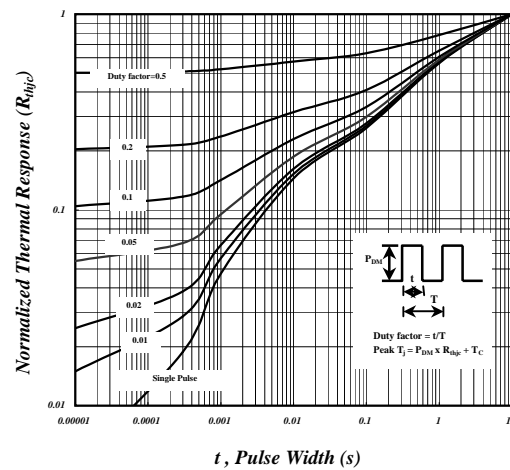

Fig 10. Effective Transient Thermal Impedance

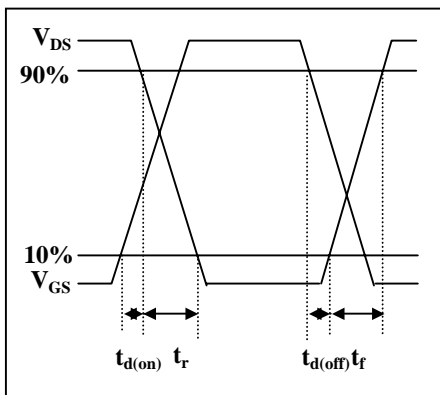

Fig 11. Switching Time Waveform

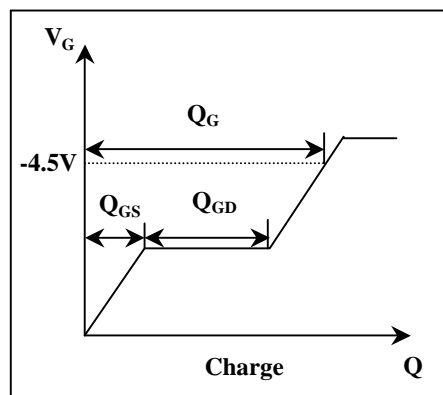
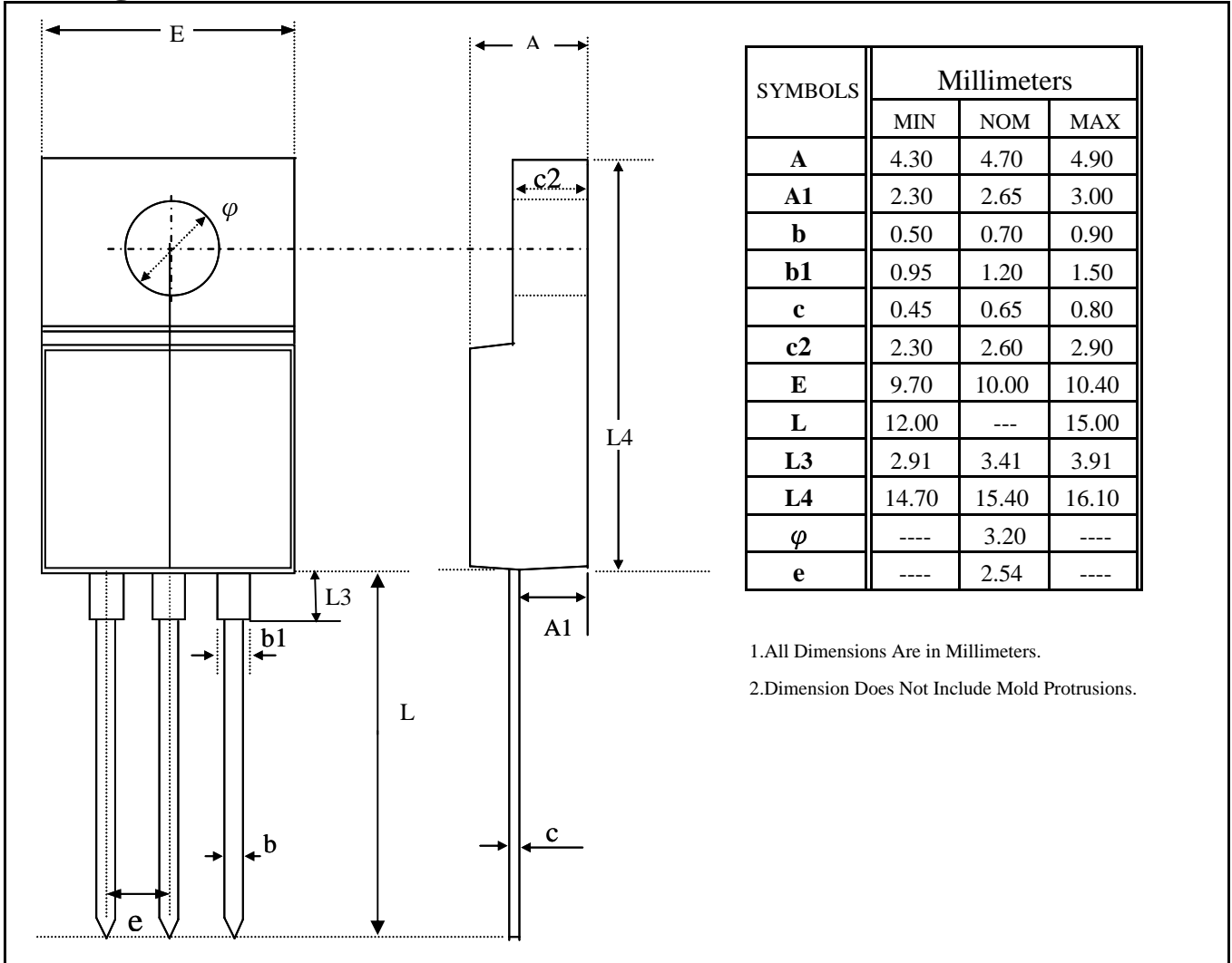

Fig 12. Gate Charge Waveform



Package Outline : TO-220CFM



Part Marking Information & Packing : TO-220CFM

