



# High-Accuracy, High-Side Current Monitors in SOT23

MAX4004/MAX4006

## General Description

The MAX4004/MAX4006 precision, high-side, current monitors are specifically designed for monitoring photodiode current in fiber applications. They offer a connection point for the reference current and a monitor output that produces a signal proportional to the reference current. The monitor output of the MAX4004 is a current proportional to the reference current. The monitor output of the MAX4006 is a voltage proportional to the reference current. The current monitors have six decades of dynamic range and monitor reference current of 250nA to 2.5mA with better than 5% accuracy. The photodiode current can be monitored from 10nA to 10mA with reduced accuracy.

The MAX4004/MAX4006 accept a +2.7V to +22V supply voltage, suitable for PIN photodiode applications. (For higher voltage applications, refer to the MAX4007/MAX4008 data sheet.) Internal current limiting (20mA, typ) protects the device against short-circuit-to-ground or excessive current conditions. A clamp diode protects the monitor output from overvoltage. Additionally, these devices feature thermal shutdown if the die temperature reaches +150°C.

The MAX4004/MAX4006 are available in tiny, space-saving 6-pin SOT23 packages, and operate over the extended temperature range of -40°C to +85°C.

## Applications

Photodiode Current-Monitoring Systems  
 Portable Instrumentation  
 Medical Instrumentation  
 Laboratory Instrumentation  
 Consumer Electronics  
 Current-to-Voltage Conversion  
 Level Translation

## Selector Guide

PART	PIN-PACKAGE	INTERNAL RESISTOR	TYPICAL ACCURACY
MAX4004EUT-T	6 SOT23-6	None	5%
MAX4006EUT-T	6 SOT23-6	10kΩ	1%

*Typical Operating Circuit appears at end of data sheet.*

## Features

- ◆ **Wide Reference Current Dynamic Range**  
 Guaranteed 250nA to 2.5mA with 5% Accuracy  
 Extended 10nA to 10mA with 10% Monitor Accuracy
- ◆ **Current (MAX4004) or Voltage (MAX4006) Monitor Output**
- ◆ **Reference Current-Limit Protection (20mA, typ)**
- ◆ **Voltage Clamp Protects Subsequent Output Circuitry**
- ◆ **+2.7V to +22V Wide Voltage Range Operation**
- ◆ **6-Pin SOT23 Packages**

## Ordering Information

PART	PIN-PACKAGE	TOP MARK	PKG CODE
MAX4004EUT-T	6 SOT23-6	ABNL	U6S-3
MAX4006EUT-T	6 SOT23-6	ABNN	U6S-3

**Note:** All devices are specified over the -40°C to +85°C operating temperature range.

## Pin Configuration

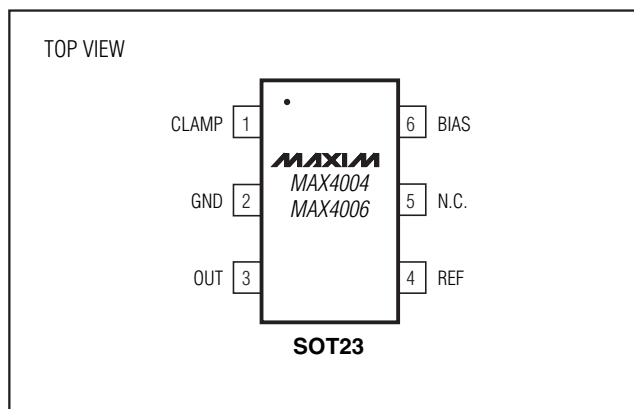

**For pricing, delivery, and ordering information, please contact Maxim/Dallas Direct! at 1-888-629-4642, or visit Maxim's website at [www.maxim-ic.com](http://www.maxim-ic.com).**

# High-Accuracy, High-Side Current Monitors in SOT23

## ABSOLUTE MAXIMUM RATINGS

CLAMP to GND .....-0.3V to +25V  
 BIAS, REF to GND .....-0.3V to +25V  
 OUT to GND .....-0.3V to (V<sub>CLAMP</sub> + 0.6V)  
 Short-Circuit, REF to GND.....Continuous  
 Current into any Pin .....±30mA  
 Continuous Power Dissipation (T<sub>A</sub> = +70°C)  
 6-Pin SOT23 (derate 8.7mW/°C above +70°C).....696mW

Operating Temperature Range .....-40°C to +85°C  
 Junction Temperature .....+150°C  
 Storage Temperature Range .....-65°C to +150°C  
 Lead Temperature (soldering, 10s) .....+300°C

Stresses beyond those listed under "Absolute Maximum Ratings" may cause permanent damage to the device. These are stress ratings only, and functional operation of the device at these or any other conditions beyond those indicated in the operational sections of the specifications is not implied. Exposure to absolute maximum rating conditions for extended periods may affect device reliability.

## ELECTRICAL CHARACTERISTICS

(V<sub>BIAS</sub> = 5V, GND = 0V, REF = Open, V<sub>OUT</sub> = 0V (MAX4004), CLAMP = Open, T<sub>A</sub> = -40°C to +85°C. Typical values are at T<sub>A</sub> = +25°C, unless otherwise noted.) (Note 1)

PARAMETER	SYMBOL	CONDITIONS	MIN	TYP	MAX	UNITS
Bias Voltage Range	V <sub>BIAS</sub>	Inferred from power-supply rejection test	2.7		22	V
Bias Quiescent Current	I <sub>BIAS</sub>	I <sub>REF</sub> = 250nA		40	100	μA
		I <sub>REF</sub> = 2.5mA		3.6	4	mA
Reference Voltage	V <sub>REF</sub>	I <sub>REF</sub> = 2.5mA	V <sub>BIAS</sub> - 1.1	V <sub>BIAS</sub> - 0.8		V
Thermal Shutdown Engage Temperature	T <sub>SHDN</sub>	REF shorted to GND, junction temperature rising		150		°C
Trip-Point Temperature Hysteresis	T <sub>HYS</sub>	REF shorted to GND, junction temperature falling		5		°C
Input Current Limit	I <sub>LIM</sub>	V <sub>REF</sub> = V <sub>BIAS</sub> - 5V		20		mA
MAX4004 Output Current Noise	i <sub>NOUT</sub>	f = 0.1Hz to 10Hz	I <sub>REF</sub> = 250nA	0.3		pA <sub>RMS</sub>
			I <sub>REF</sub> = 2.5mA	63		
		f = 0.1Hz to 10kHz	I <sub>REF</sub> = 250nA	9.2		
			I <sub>REF</sub> = 2.5mA	1240		
MAX4006 Output Voltage Noise	e <sub>NOUT</sub>	f = 0.1Hz to 10Hz	I <sub>REF</sub> = 250nA	0.041		μV <sub>RMS</sub>
			I <sub>REF</sub> = 2.5mA	0.63		
		f = 0.1Hz to 10kHz	I <sub>REF</sub> = 250nA	1.3		
			I <sub>REF</sub> = 2.5mA	12.5		
Output Resistance	R <sub>OUT</sub>	MAX4004	I <sub>REF</sub> = 250nA	50		GΩ
			I <sub>REF</sub> = 2.5mA	5		MΩ
		MAX4006		10		kΩ
Output Leakage		REF = open		1		pA
Output Voltage Range	V <sub>OUT</sub>	V <sub>BIAS</sub> = 2.7V to 22V, I <sub>REF</sub> = 0 to 1mA, MAX4004: ΔI <sub>OUT</sub> /I <sub>OUT</sub> = ±1%, MAX4006: ΔV <sub>OUT</sub> /I <sub>OUT</sub> = ±1%	0 to V <sub>BIAS</sub> - 1.5	0 to V <sub>BIAS</sub> - 0.85		V

# High-Accuracy, High-Side Current Monitors in SOT23

**MAX4004/MAX4006**

## ELECTRICAL CHARACTERISTICS (continued)

(V<sub>BIAS</sub> = 5V, GND = 0V, REF = Open, V<sub>OUT</sub> = 0V (MAX4004), CLAMP = Open, T<sub>A</sub> = -40°C to +85°C. Typical values are at T<sub>A</sub> = +25°C, unless otherwise noted.) (Note 1)

PARAMETER	SYMBOL	CONDITIONS		MIN	TYP	MAX	UNITS
Output Clamp Voltage	V <sub>OUT</sub> - V <sub>CLAMP</sub>				0.6		V
Output Clamp Leakage		V <sub>CLAMP</sub> = 0 to 22V			1		pA
MAX4004 Current Gain	I <sub>OUT</sub> /I <sub>REF</sub>	I <sub>REF</sub> = 250nA		0.09	0.099	0.11	mA/mA
		I <sub>REF</sub> = 2.5mA		0.094	0.095	0.106	
		I <sub>REF</sub> = 10mA, V <sub>BIAS</sub> = 12V			0.098		
MAX4006 Transimpedance Gain	V <sub>OUT</sub> /I <sub>REF</sub>	I <sub>REF</sub> = 250nA		0.9	0.995	1.1	V/mA
		I <sub>REF</sub> = 2.5mA		0.95	0.998	1.05	
		I <sub>REF</sub> = 10mA, V <sub>BIAS</sub> = 12V			0.992		
Power-Supply Rejection Ratio (PSRR)	(ΔI <sub>OUT</sub> /I <sub>OUT</sub> )/ΔV <sub>BIAS</sub>	MAX4004: V <sub>BIAS</sub> = 2.7V to 22V	I <sub>REF</sub> = 250nA I <sub>REF</sub> = 1mA		50 50	1000 1000	ppm/V
	(ΔV <sub>OUT</sub> /V <sub>OUT</sub> )/ΔV <sub>BIAS</sub>	MAX4006: V <sub>BIAS</sub> = 2.7V to 22V	I <sub>REF</sub> = 1mA		50	1000	
Power-Up Settling Time	t <sub>s</sub>	I <sub>OUT</sub> settles within 0.1%, C <sub>IN</sub> = 10nF between REF and GND			7.5		ms
						90	μs

**Note 1:** All devices are 100% tested at room temperature (T<sub>A</sub> = +25°C). All temperature limits are guaranteed by design.

# High-Accuracy, High-Side Current Monitors in SOT23

## Typical Operating Characteristics

( $T_A = +25^\circ\text{C}$ , unless otherwise noted.)

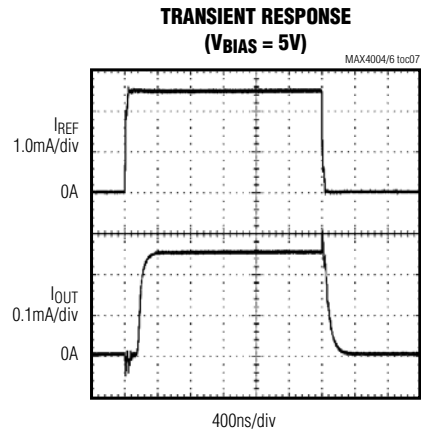
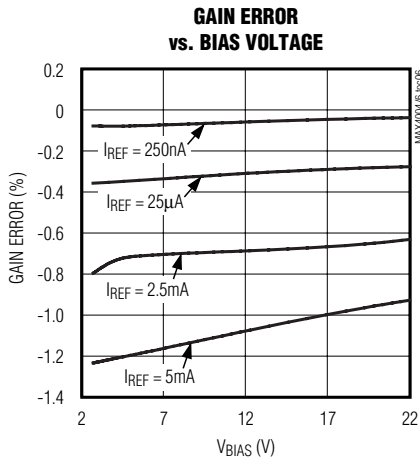
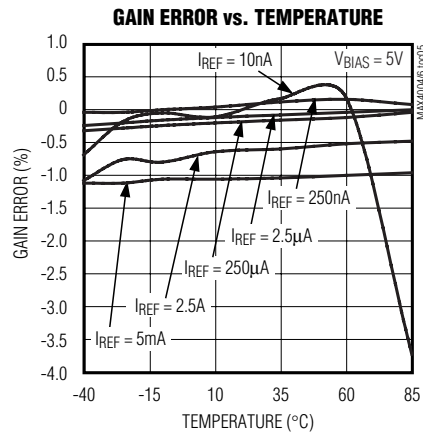
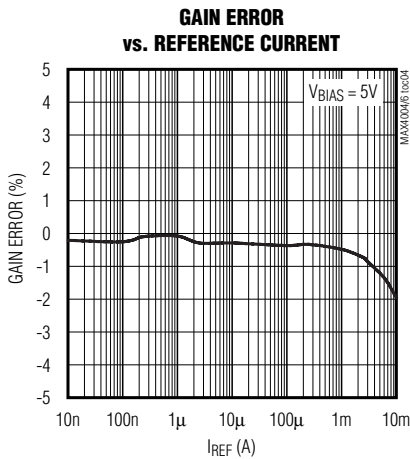
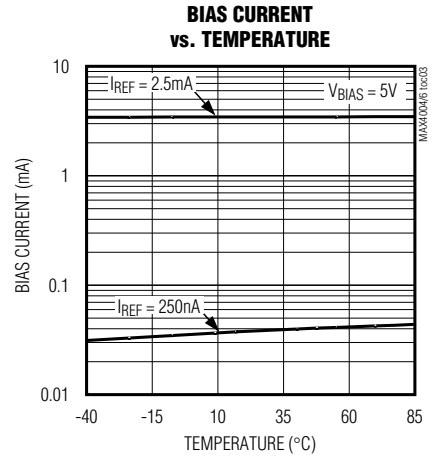
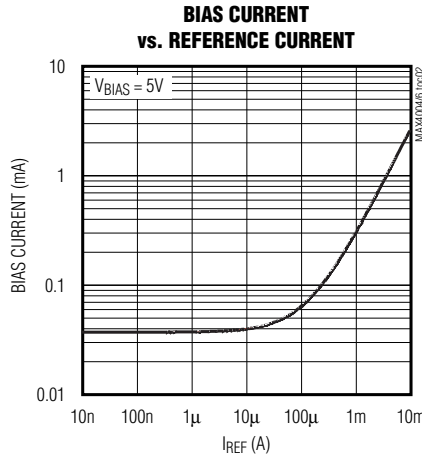
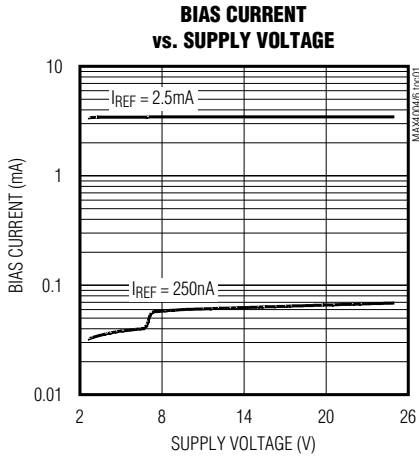

# High-Accuracy, High-Side Current Monitors in SOT23

## Typical Operating Characteristics (continued)

( $T_A = +25^\circ\text{C}$ , unless otherwise noted.)

MAX4004/MAX4006

**STARTUP DELAY**  
( $V_{\text{BIAS}} = 5\text{V}$ ,  $I_{\text{REF}} = 250\text{nA}$ )

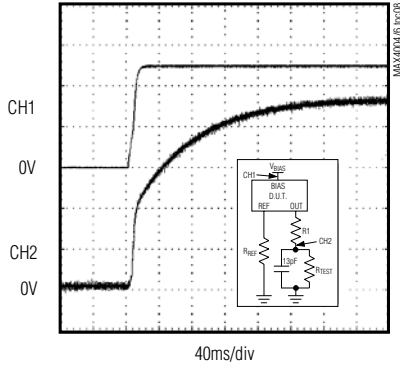

$R_{\text{REF}} = 16.8\text{M}\Omega$   
 $R_1 = 118\text{M}\Omega$   
 $R_{\text{TEST}} = 1.67\text{M}\Omega$   
 CH1: 2V/div  
 CH2: 10mV/div

**STARTUP DELAY**  
( $V_{\text{BIAS}} = 5\text{V}$ ,  $I_{\text{REF}} = 2.5\text{mA}$ )

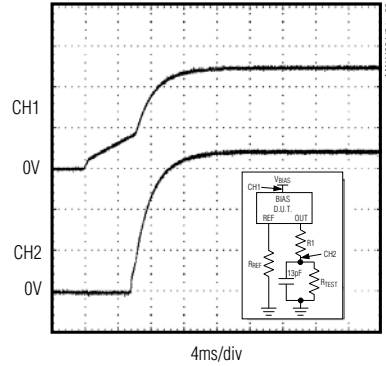

$R_{\text{REF}} = 1.68\text{k}\Omega$   
 $R_1 = 0\Omega$   
 $R_{\text{TEST}} = 14.0\text{k}\Omega$   
 CH1: 2V/div  
 CH2: 1V/div

**STARTUP DELAY**  
( $V_{\text{BIAS}} = 2.7\text{V}$ ,  $I_{\text{REF}} = 250\text{nA}$ )

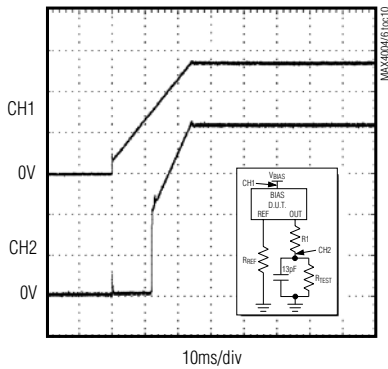

$R_{\text{REF}} = 8.8\text{M}\Omega$   
 $R_1 = 0\Omega$   
 $R_{\text{TEST}} = 8.1\text{M}\Omega$   
 CH1: 1V/div  
 CH2: 50mV/div

**STARTUP DELAY**  
( $V_{\text{BIAS}} = 2.7\text{V}$ ,  $I_{\text{REF}} = 2.5\text{mA}$ )

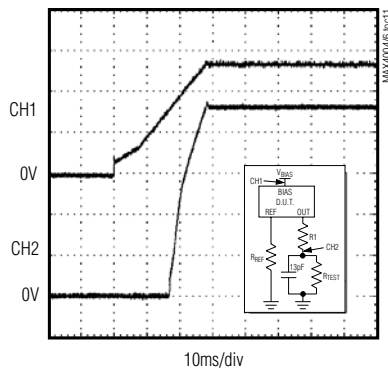

$R_{\text{REF}} = 794\Omega$   
 $R_1 = 0\Omega$   
 $R_{\text{TEST}} = 4.01\text{k}\Omega$   
 CH1: 1V/div  
 CH2: 200mV/div

**SHORT-CIRCUIT RESPONSE**  
( $V_{\text{BIAS}} = 5\text{V}$ )

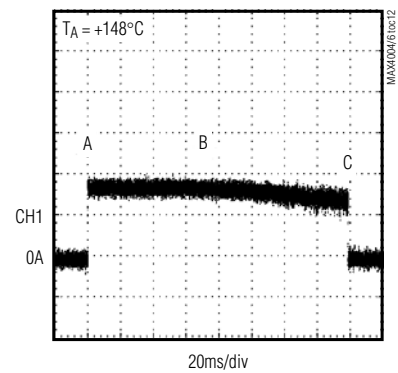

CH1:  $I_{\text{BIAS}}$ , 10mA/div  
 A: REF SHORTS TO GND  
 B: CURRENT LIMIT ACTIVE  
 C: THERMAL SHUTDOWN

# High-Accuracy, High-Side Current Monitors in SOT23

## Typical Operating Characteristics (continued)

( $T_A = +25^\circ\text{C}$ , unless otherwise noted.)

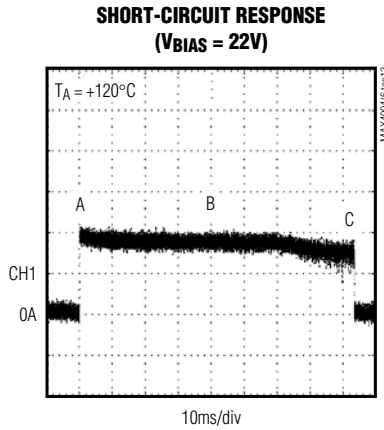

CH1:  $I_{\text{BIAS}}$ , 10mA/div  
 A: REF SHORTS TO GND  
 B: CURRENT LIMIT ACTIVE  
 C: THERMAL SHUTDOWN

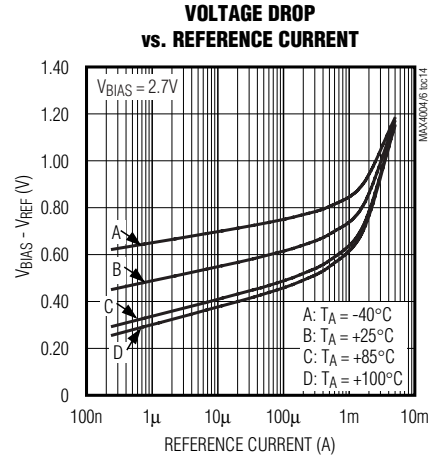

## Pin Description

PIN		NAME	FUNCTION
MAX4004	MAX4006		
1	1	CLAMP	Clamp Voltage Input. External potential used for voltage clamping of $V_{\text{OUT}}$ .
2	2	GND	Ground
3	—	OUT	Current-Monitor Output. OUT sources a current of $1/10\text{th } I_{\text{REF}}$ .
4	4	REF	Reference Current Output. REF provides the source current to the cathode of the photodiode.
5	5	N.C.	No Connection. Not internally connected.
6	6	BIAS	Bias Voltage Input. Bias voltage for photodiode.
—	3	OUT	Current-Monitor Output. OUT presents a voltage proportional to $I_{\text{REF}}$ at $1\text{V}/\text{mA}$ . An internal $10\text{k}\Omega$ resistor connects OUT to GND (see <i>Functional Diagram</i> ).

# High-Accuracy, High-Side Current Monitors in SOT23

## Functional Diagrams

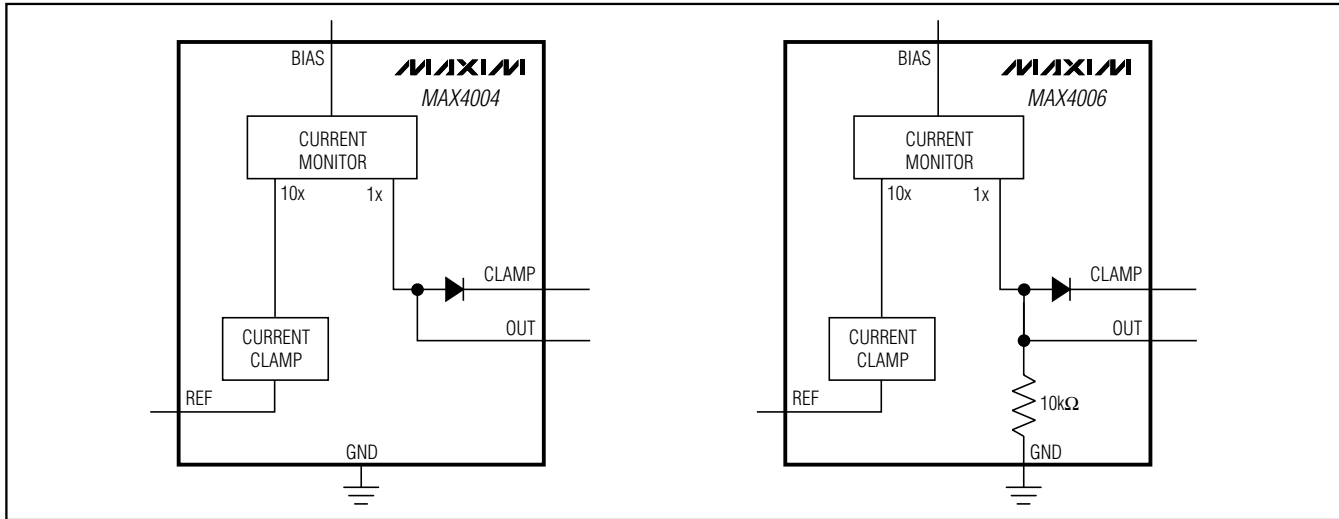

MAX4004/MAX4006

### Detailed Description

The MAX4004/MAX4006 are versatile current monitors intended for monitoring DC photodiode current in fiber applications (see the *Functional Diagram*). The MAX4004 output is a current that is exactly one-tenth of the reference current. The MAX4006 outputs a voltage that is proportional to the reference current with a transimpedance gain of 1V/mA achieved by a factory-trimmed, internal 10kΩ resistor.

Both current devices have six decades of dynamic range and monitor reference current ranging from 250nA to 2.5mA, the nominal operating range, with better than 5% accuracy across the entire reference current, bias voltage, and temperature ranges. The corresponding monitor outputs produce 25nA to 0.25mA (MAX4004) and 0.25mV to 2.5V (MAX4006). When the reference currents are extended to the broader range of 10nA to 10mA, an accuracy of less than 10% is maintained. Internal current limiting (20mA, typ) protects the device against short-circuit-to-ground conditions, and a thermal shutdown feature reduces both the reference current and the monitor current to zero if the die temperature reaches +150°C.

The MAX4004/MAX4006 accept a +2.7V to +22V supply voltage, suitable for PIN photodiode applications. A clamping diode, shown in the *Functional Diagram*, is provided to protect subsequent output circuitry from an overvoltage condition.

### Applications Information

#### Clamping the Monitor Output Voltage

CLAMP provides a means for diode clamping the voltage at OUT, thus  $V_{OUT}$  is limited to  $V_{CLAMP} + 0.6V$ . CLAMP can be connected to either an external supply, to BIAS, or can be left floating if voltage clamping is not required.

#### Using PIN Photodiodes in Fiber Applications

When using the MAX4004/MAX4006 to monitor PIN photodiode currents in fiber applications, several issues must be addressed. In applications where the photodiode must be fully depleted, keep track of voltages budgeted for each component with respect to the available supply voltage(s). The current monitor requires as much as 1.2V between BIAS and REF, which must be considered as part of the overall voltage budget.

Additional voltage margin can be created if a negative supply is used in place of a ground connection, as long as the overall voltage drop experienced by the MAX4004/MAX4006 is less than or equal to 22V. For this type of application, the MAX4004 is suggested so the output can be referenced to "true" ground and not the negative supply. The MAX4004's output current can be referenced as desired with either a resistor to ground or a transimpedance amplifier. Take care to ensure that output voltage excursions do not interfere with the required margin between BIAS and OUT.

## High-Accuracy, High-Side Current Monitors in SOT23

In many fiber applications, OUT is connected directly to an ADC that operates from a supply voltage that is less than the voltage at BIAS. Connecting the MAX4004/MAX4006's clamping diode output, CLAMP, to the ADC power supply helps avoid damage to the ADC. Without this protection, voltages can develop at OUT that can destroy the ADC. This protection is less critical when OUT is connected directly to subsequent transimpedance amplifiers (linear or logarithmic) that have low-impedance, near-ground-referenced inputs. If a transimpedance amp is used on the low side of the photodiode, its voltage drop must also be considered. Leakage from the clamping diode is most often insignificant over nominal operating conditions, but grows with temperature.

To maintain low levels of wideband noise, lowpass filtering the output signal is suggested in applications where only DC measurements are required. Determining the required filtering components is straightforward, as the MAX4004 exhibits a very high output impedance ( $>5M\Omega$ ), while the MAX4006 exhibits an output resistance of  $10k\Omega$ .

In some applications where pilot tones are used to identify specific fiber channels, higher bandwidths are desired at OUT to detect these tones. Consider the minimum and maximum currents to be detected, then consult the frequency response and noise typical operating curves. If the minimum current is too small, insufficient monitor bandwidth could result, while too high of a current could result in excessive monitor noise across the desired bandwidth.

### **Bypassing and External Components**

In applications where power-supply noise can interfere with DC diode measurements, additional filtering is suggested. Such noise is commonly seen when switching power supplies are used to generate the photodiode bias voltage. As shown in the typical operating circuit, a pi filter (two  $0.22\mu\text{F}$  capacitors and one  $2.2\mu\text{H}$  inductor) greatly suppress power-supply switching noise. If such a filter is already present in the bias-generating circuit, only a simple bypass capacitor at the BIAS pin is suggested. The output lowpass filter, a  $10k\Omega$  resistor and a  $10\text{nF}$  capacitor, further reduce permeating power-supply noise as well as other wideband noise that might otherwise restrict measurements at low signal levels. Again, reducing the bandwidth of the OUT signal can affect performance of pilot-tone systems.

To restrict high-frequency photodiode signals from affecting the current monitor and BIAS power supply, an RF choke and  $10\text{nF}$  capacitor can be added. The capacitance presented to REF should not exceed  $10\text{nF}$ ; larger values increase startup time and could cause the thermal shutdown circuit to activate during startup.



# High-Accuracy, High-Side Current Monitors in SOT23

## Typical Operating Circuit

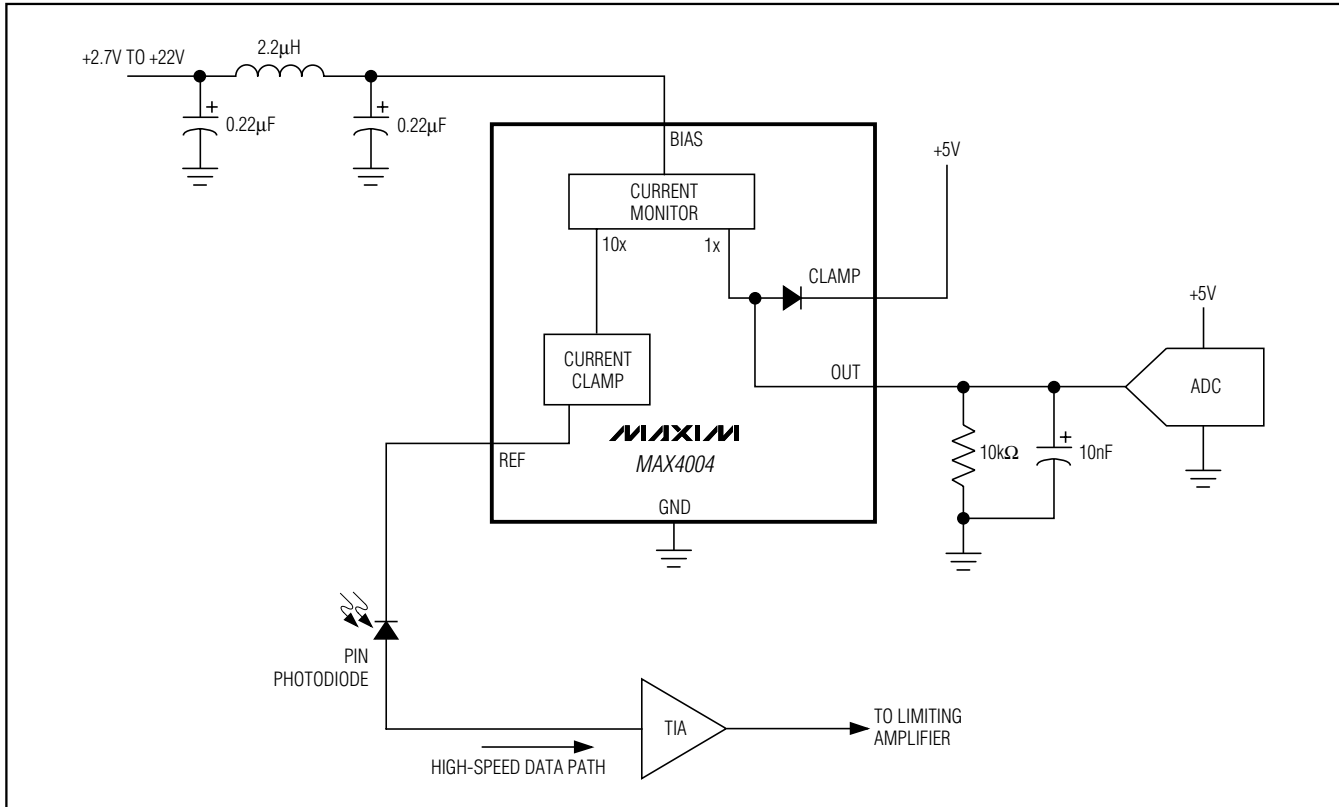

MAX4004/MAX4006

## Chip Information

TRANSISTOR COUNT: 195

PROCESS: BiCMOS

# High-Accuracy, High-Side Current Monitors in SOT23

## Package Information

(The package drawing(s) in this data sheet may not reflect the most current specifications. For the latest package outline information, go to [www.maxim-ic.com/packages](http://www.maxim-ic.com/packages).)

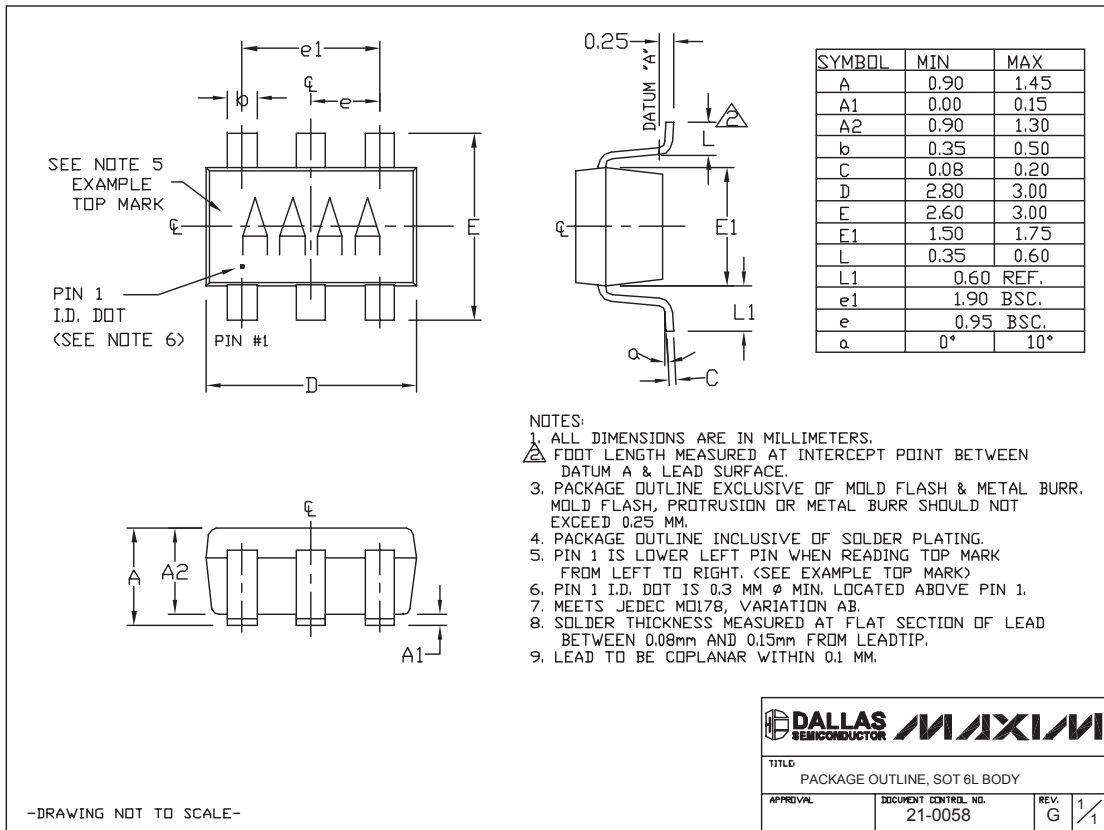

Maxim cannot assume responsibility for use of any circuitry other than circuitry entirely embodied in a Maxim product. No circuit patent licenses are implied. Maxim reserves the right to change the circuitry and specifications without notice at any time.

10 **Maxim Integrated Products, 120 San Gabriel Drive, Sunnyvale, CA 94086 408-737-7600**

© 2006 Maxim Integrated Products

Printed USA

**MAXIM** is a registered trademark of Maxim Integrated Products, Inc.