



# Low-Cost, Precision, High-Side Current-Sense Amplifier

MAX4172

## General Description

The MAX4172 is a low-cost, precision, high-side current-sense amplifier for portable PCs, telephones, and other systems where battery/DC power-line monitoring is critical. High-side power-line monitoring is especially useful in battery-powered systems, since it does not interfere with the battery charger's ground path. Wide bandwidth and ground-sensing capability make the MAX4172 suitable for closed-loop battery-charger and general-purpose current-source applications. The 0V to 32V input common-mode range is independent of the supply voltage, which ensures that current-sense feedback remains viable, even when connected to a battery in deep discharge.

To provide a high level of flexibility, the MAX4172 functions with an external sense resistor to set the range of load current to be monitored. It has a current output that can be converted to a ground-referred voltage with a single resistor, accommodating a wide range of battery voltages and currents.

An open-collector power-good output ( $\overline{\text{PG}}$ ) indicates when the supply voltage reaches an adequate level to guarantee proper operation of the current-sense amplifier. The MAX4172 operates with a 3.0V to 32V supply voltage, and is available in a space-saving, 8-pin  $\mu\text{MAX}$ ® or SO package.

## Applications

Portable PCs: Notebooks/Subnotebooks/Palmtops  
 Battery-Powered/Portable Equipment  
 Closed-Loop Battery Chargers/Current Sources  
 Smart-Battery Packs  
 Portable/Cellular Phones  
 Portable Test/Measurement Systems  
 Energy Management Systems

## Pin Configuration

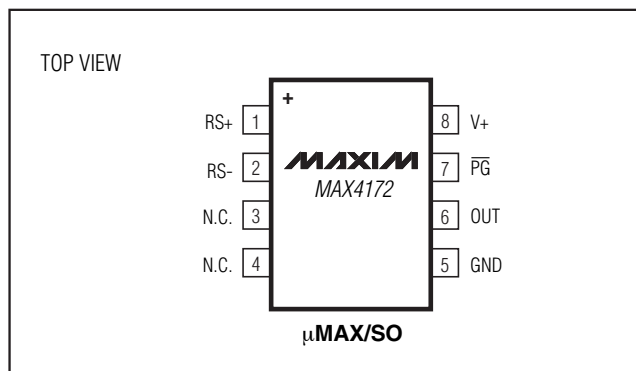

$\mu\text{MAX}$  is a registered trademark of Maxim Integrated Products, Inc.

## Features

- ◆ Low-Cost, High-Side Current-Sense Amplifier
- ◆  $\pm 0.5\%$  Typical Full-Scale Accuracy Over Temperature
- ◆ 3V to 32V Supply Operation
- ◆ High Accuracy +2V to +32V Common-Mode Range, Functional Down to 0V, Independent of Supply Voltage
- ◆ 800kHz Bandwidth [ $V_{\text{SENSE}} = 100\text{mV}$  (1C)]  
200kHz Bandwidth [ $V_{\text{SENSE}} = 6.25\text{mV}$  (C/16)]
- ◆ Available in Space-Saving  $\mu\text{MAX}$  and SO Packages

## Ordering Information

PART	TEMP. RANGE	PIN-PACKAGE
MAX4172ESA+	-40°C to +85°C	8 SO
MAX4172EUA+	-40°C to +85°C	8 $\mu\text{MAX}$

+ Denotes a lead(Pb)-free/RoHS-compliant package.

## Typical Operating Circuit

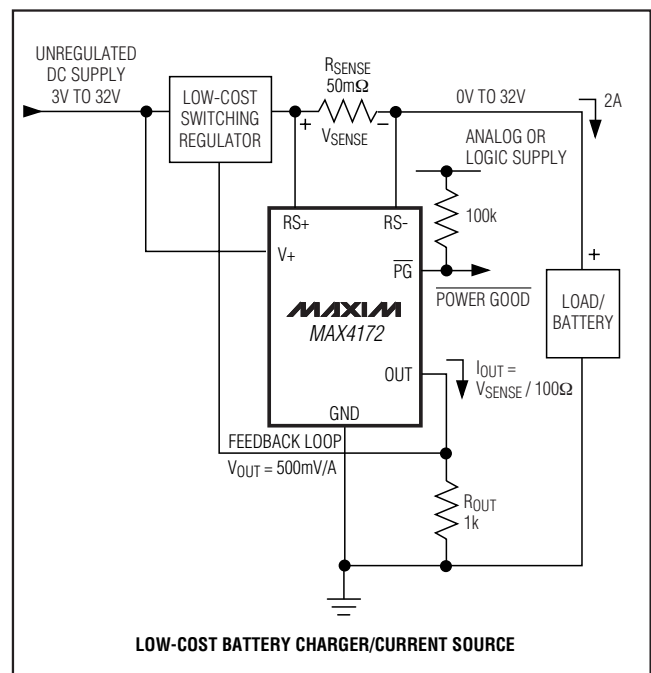

# Low-Cost, Precision, High-Side Current-Sense Amplifier

## ABSOLUTE MAXIMUM RATINGS

V+, RS+, RS-, $\overline{PG}$ .....	-0.3V to +36V
OUT .....	-0.3V to (V+ + 0.3V)
Differential Input Voltage, V <sub>RS+</sub> - V <sub>RS-</sub> .....	±700mV
Current into Any Pin .....	±50mA
Continuous Power Dissipation (T <sub>A</sub> = +70°C)	
SO (derate 5.88mW/°C above +70°C) .....	471mW
μMAX (derate 4.10mW/°C above +70°C) .....	330mW

Operating Temperature Range	
MAX4172E_A .....	-40°C to +85°C
Storage Temperature Range .....	-65°C to +150°C
Lead Temperature (soldering, 10s) .....	+300°C
Soldering Temperature (reflow) .....	+260°C

Stresses beyond those listed under "Absolute Maximum Ratings" may cause permanent damage to the device. These are stress ratings only, and functional operation of the device at these or any other conditions beyond those indicated in the operational sections of the specifications is not implied. Exposure to absolute maximum rating conditions for extended periods may affect device reliability.

## ELECTRICAL CHARACTERISTICS

(V+ = +3V to +32V; V<sub>RS+</sub>, V<sub>RS-</sub> = 0V to 32V; T<sub>A</sub> = T<sub>MIN</sub> to T<sub>MAX</sub>; unless otherwise noted. Typical values are at V+ = +12V, V<sub>RS+</sub> = 12V, T<sub>A</sub> = +25°C.)

PARAMETER	SYMBOL	CONDITIONS	MIN	TYP	MAX	UNITS
Operating Voltage Range	V+		3		32	V
Input Voltage Range	V <sub>RS-</sub>		0		32	V
Supply Current	I <sub>V+</sub>	I <sub>OUT</sub> = 0mA		0.8	1.6	mA
Input Offset Voltage	V <sub>OS</sub>	V+ = 12V, V <sub>RS+</sub> = 12V		±0.1	±0.75	mV
				±0.2	±1.6	
		V <sub>RS+</sub> ≤ 2.0V		4		
Positive Input Bias Current	I <sub>RS+</sub>	V <sub>RS+</sub> > 2.0V, I <sub>OUT</sub> = 0mA	0	27	42.5	μA
		V <sub>RS+</sub> ≤ 2.0V, I <sub>OUT</sub> = 0mA	-325		42.5	
Negative Input Bias Current	I <sub>RS-</sub>	V <sub>RS+</sub> > 2.0V	0	50	85	μA
		V <sub>RS+</sub> ≤ 2.0V	-650		85	
Maximum V <sub>SENSE</sub> Voltage			150	175		mV
Low-Level Current Error		V <sub>SENSE</sub> = 6.25mV, V+ = 12V, V <sub>RS+</sub> = 12V (Note 1)			±8.0	μA
					±15	
Output Current Error		V <sub>SENSE</sub> = 100mV, V+ = 12V, V <sub>RS+</sub> = 12V			±20	μA
					±50	
					±10	
					±15	
OUT Power-Supply Rejection Ratio	ΔI <sub>OUT</sub> / ΔV+	3V ≤ V+ ≤ 32V, V <sub>RS+</sub> > 2.0V		0.2		μA/V
OUT Common-Mode Rejection Ratio	ΔI <sub>OUT</sub> / ΔV <sub>RS+</sub>	2.0V < V <sub>RS+</sub> < 32V		0.03		μA/V

# Low-Cost, Precision, High-Side Current-Sense Amplifier

## ELECTRICAL CHARACTERISTICS (continued)

(V+ = +3V to +32V; VRS+, VRS- = 0V to 32V; TA = TMIN to TMAX; unless otherwise noted. Typical values are at V+ = +12V, VRS+ = 12V, TA = +25°C.)

PARAMETER	SYMBOL	CONDITIONS	MIN	TYP	MAX	UNITS	
Maximum Output Voltage (OUT)		IOUT ≤ 1.5mA		V+ - 1.2		V	
Bandwidth		VSENSE = 100mV		800		kHz	
		VSENSE = 6.25mV (Note 1)		200			
Maximum Output Current	IOUT		1.5	1.75		mA	
Transconductance	Gm	Gm = IOUT / (VRS+ - VRS-), VSENSE = 100mV, VRS+ > 2.0V	TA = 0°C to +85°C	9.8	10	10.2	mA/V
			TA = -40°C to 0°C	9.7	10	10.3	
V+ Threshold for $\overline{\text{PG}}$ Output Low (Note 2)		V+ rising V+ falling		2.77		V	
				2.67			
$\overline{\text{PG}}$ Output Low Voltage	VOL	ISINK = 1.2mA, V+ = 2.9V, TA = +25°C			0.4	V	
Leakage Current into $\overline{\text{PG}}$		V+ = 2.5V, TA = +25°C			1	μA	
Power-Off Input Leakage Current (RS+, RS-)		V+ = 0V, VRS+ = VRS- = 32V		0.1	1	μA	
OUT Rise Time		VSENSE = 0mV to 100mV, 10% to 90%		400		ns	
OUT Fall Time		VSENSE = 100mV to 0mV, 90% to 10%		800		ns	
OUT Settling Time to 1%		VSENSE = 5mV to 100mV	Rising	1.3		μs	
			Falling	6			
OUT Output Resistance		VSENSE = 150mV		20		MΩ	

**Note 1:** 6.25mV = 1/16 of typical full-scale sense voltage (C/16).

**Note 2:** Valid operation of the MAX4172 is guaranteed by design when  $\overline{\text{PG}}$  is low.

## Typical Operating Characteristics

(V+ = +12V, VRS+ = 12V, ROUT = 1kΩ, TA = +25°C, unless otherwise noted.)

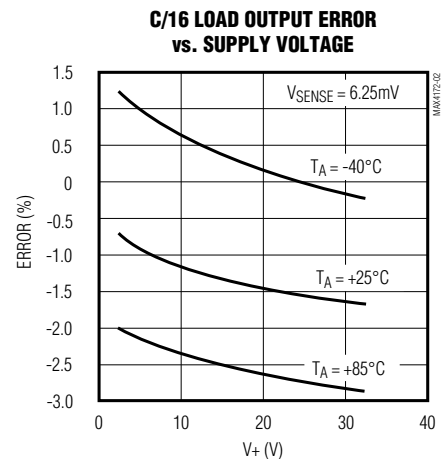
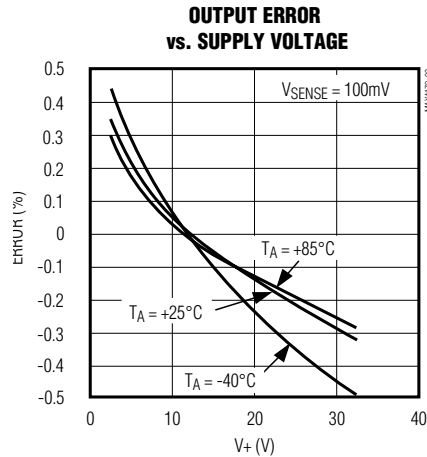
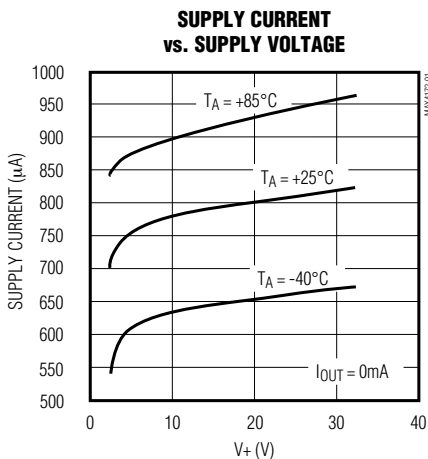

# Low-Cost, Precision, High-Side Current-Sense Amplifier

## Typical Operating Characteristics (continued)

( $V_+ = +12V$ ,  $V_{RS+} = 12V$ ,  $R_{OUT} = 1k\Omega$ ,  $T_A = +25^\circ C$ , unless otherwise noted.)

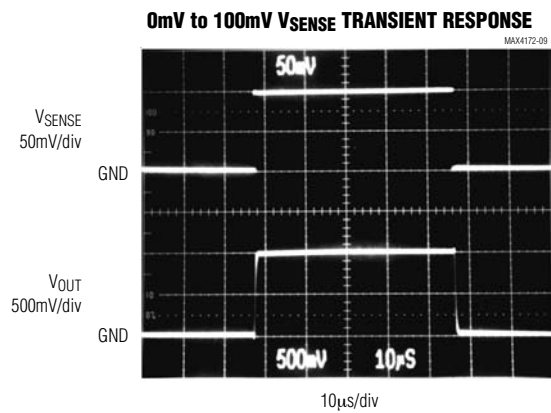
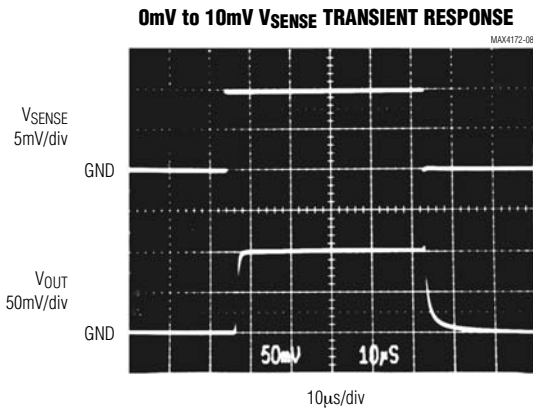
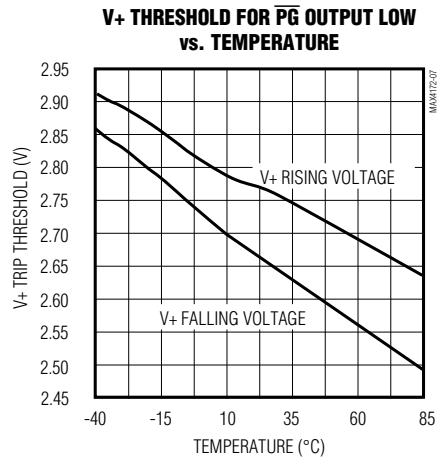
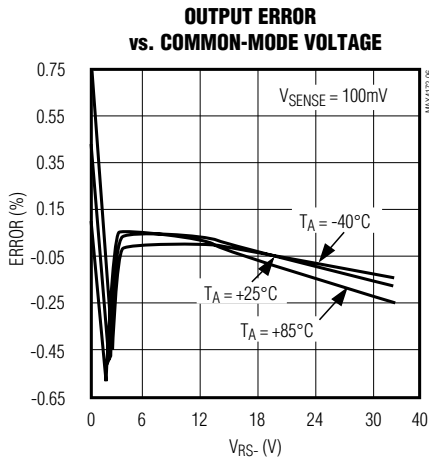
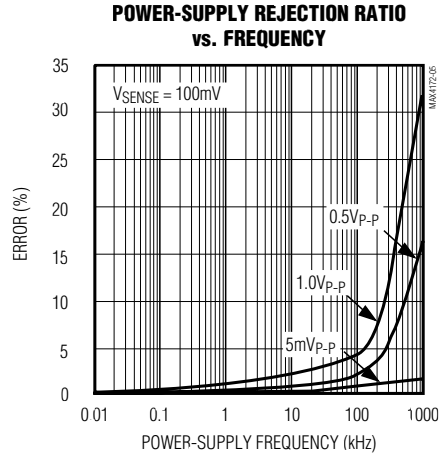
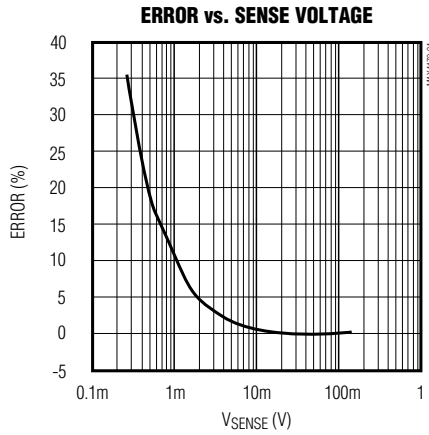

# Low-Cost, Precision, High-Side Current-Sense Amplifier

MAX4172

## Typical Operating Characteristics (continued)

( $V_+ = +12V$ ,  $V_{RS+} = 12V$ ,  $R_{OUT} = 1k\Omega$ ,  $T_A = +25^\circ C$ , unless otherwise noted.)

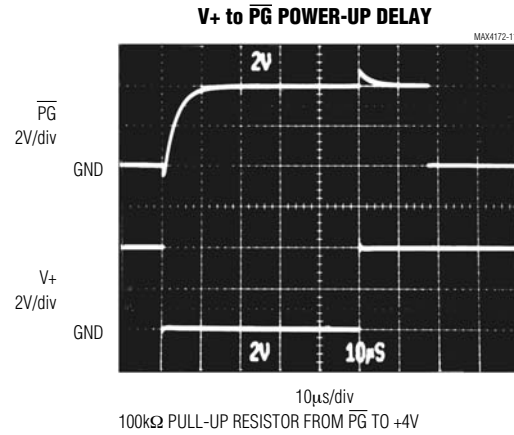
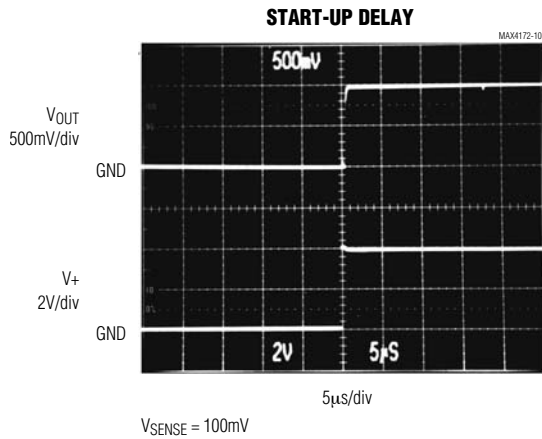

## Pin Description

PIN	NAME	FUNCTION
1	RS+	Power connection to the external sense resistor. The "+" indicates the direction of current flow.
2	RS-	Load-side connection for the external sense resistor. The "-" indicates the direction of current flow.
3, 4	N.C.	No Connect. No internal connection. Leave open or connect to GND.
5	GND	Ground
6	OUT	Current Output. OUT is proportional to the magnitude of the sense voltage ( $V_{RS+} - V_{RS-}$ ). A 1kΩ resistor from OUT to ground will result in a voltage equal to 10V/V of sense voltage.
7	$\overline{PG}$	Power Good Open-Collector Logic Output. A low level indicates that $V_+$ is sufficient to power the MAX4172, and adequate time has passed for power-on transients to settle out.
8	V+	Supply Voltage Input for the MAX4172

## Detailed Description

The MAX4172 is a unidirectional, high-side current-sense amplifier with an input common-mode range that is independent of supply voltage. This feature not only allows the monitoring of current flow into a battery in deep discharge, but also enables high-side current sensing at voltages far in excess of the supply voltage ( $V_+$ ).

The MAX4172 current-sense amplifier's unique topology simplifies current monitoring and control. The MAX4172's amplifier operates as shown in Figure 1. The battery/load current flows through the external sense resistor ( $R_{SENSE}$ ), from the  $RS_+$  node to the  $RS_-$

node. Current flows through  $R_{G1}$  and  $Q1$ , and into the current mirror, where it is multiplied by a factor of 50 before appearing at OUT.

To analyze the circuit of Figure 1, assume that current flows from  $RS_+$  to  $RS_-$ , and that OUT is connected to GND through a resistor. Since A1's inverting input is high impedance, no current flows through  $R_{G2}$  (neglecting the input bias current), so A1's negative input is equal to  $V_{SOURCE} - (I_{LOAD} \times R_{SENSE})$ . A1's open-loop gain forces its positive input to essentially the same voltage level as the negative input. Therefore, the drop across  $R_{G1}$  equals  $I_{LOAD} \times R_{SENSE}$ . Then, since  $I_{RG1}$

# Low-Cost, Precision, High-Side Current-Sense Amplifier

flows through  $R_{G1}$ ,  $I_{RG1} \times R_{G1} = I_{LOAD} \times R_{SENSE}$ . The internal current mirror multiplies  $I_{RG1}$  by a factor of 50 to give  $I_{OUT} = 50 \times I_{RG1}$ . Substituting  $I_{OUT} / 50$  for  $I_{RG1}$ ,  $(I_{OUT} / 50) \times R_{G1} = I_{LOAD} \times R_{SENSE}$ , or:

$$I_{OUT} = 50 \times I_{LOAD} \times (R_{SENSE} / R_{G1})$$

The internal current gain of 50 and the factory-trimmed resistor  $R_{G1}$  combine to result in the MAX4172 transconductance ( $G_m$ ) of 10mA/V.  $G_m$  is defined as being equal to  $I_{OUT} / (V_{RS+} - V_{RS-})$ . Since  $(V_{RS+} - V_{RS-}) = I_{LOAD} \times R_{SENSE}$ , the output current ( $I_{OUT}$ ) can be calculated with the following formula:

$$I_{OUT} = G_m \times (V_{RS+} - V_{RS-}) = (10\text{mA/V}) \times (I_{LOAD} \times R_{SENSE})$$

## Current Output

The output voltage equation for the MAX4172 is given below:

$$V_{OUT} = (G_m) \times (R_{SENSE} \times R_{OUT} \times I_{LOAD})$$

where  $V_{OUT}$  = the desired full-scale output voltage,  $I_{LOAD}$  = the full-scale current being sensed,  $R_{SENSE}$  = the current-sense resistor,  $R_{OUT}$  = the voltage-setting resistor, and  $G_m$  = MAX4172 transconductance (10mA/V).

The full-scale output voltage range can be set by changing the  $R_{OUT}$  resistor value, but the output voltage must be no greater than  $V_+ - 1.2\text{V}$ . The above equation can be modified to determine the  $R_{OUT}$  required for a particular full-scale range:

$$R_{OUT} = (V_{OUT}) / (I_{LOAD} \times R_{SENSE} \times G_m)$$

OUT is a high-impedance current source that can be integrated by connecting it to a capacitive load.

## PG Output

The  $\overline{\text{PG}}$  output is an open-collector logic output that indicates the status of the MAX4172's  $V_+$  power supply. A logic low on the  $\overline{\text{PG}}$  output indicates that  $V_+$  is sufficient to power the MAX4172. This level is temperature dependent (see *Typical Operating Characteristics* graphs), and is typically 2.7V at room temperature. The internal  $\overline{\text{PG}}$  comparator has a 100mV (typical) hysteresis to prevent possible oscillations caused by repeated toggling of the  $\overline{\text{PG}}$  output, making the device ideal for power-management systems lacking soft-start capability. An internal delay (15 $\mu\text{s}$  typical) in the  $\overline{\text{PG}}$  comparator allows adequate time for power-on transients to settle out. The  $\overline{\text{PG}}$  status indicator greatly simplifies the design of closed-loop systems by ensuring that the components in the control loop have sufficient voltage to operate correctly.

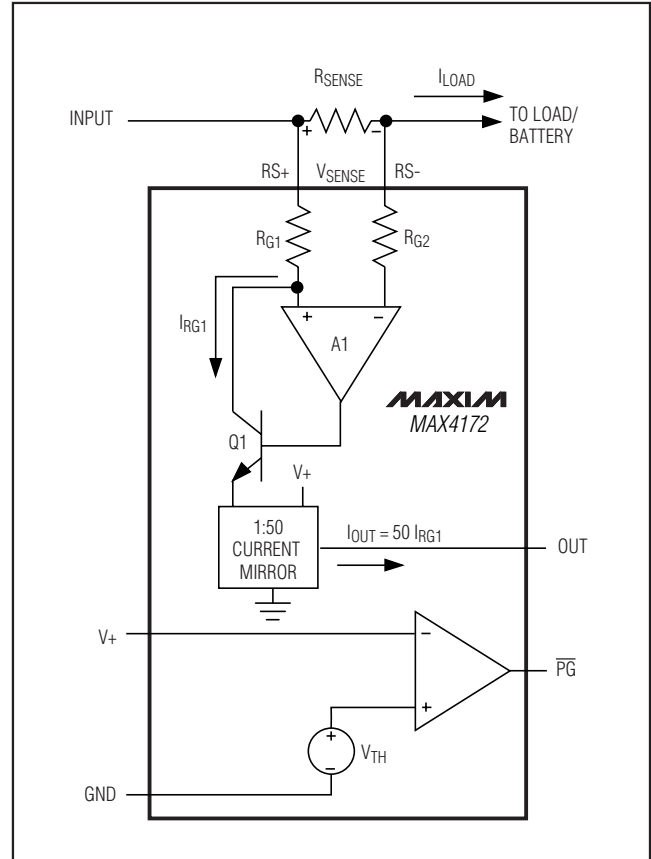

Figure 1. Functional Diagram

## Applications Information

### Suggested Component Values for Various Applications

The *Typical Operating Circuit* is useful in a wide variety of applications. Table 1 shows suggested component values and indicates the resulting scale factors for various applications required to sense currents from 100mA to 10A.

Adjust the  $R_{SENSE}$  value to monitor higher or lower current levels. Select  $R_{SENSE}$  using the guidelines and formulas in the following section.

### Sense Resistor, $R_{SENSE}$

Choose  $R_{SENSE}$  based on the following criteria:

- **Voltage Loss:** A high  $R_{SENSE}$  value causes the power-source voltage to degrade through IR loss. For minimal voltage loss, use the lowest  $R_{SENSE}$  value.



# Low-Cost, Precision, High-Side Current-Sense Amplifier

**Table 1. Suggested Component Values**

FULL-SCALE LOAD CURRENT (A)	CURRENT-SENSE RESISTOR, R <sub>SENSE</sub> (mΩ)	OUTPUT RESISTOR, R <sub>OUT</sub> (kΩ)	FULL-SCALE OUTPUT VOLTAGE, V <sub>OUT</sub> (V)	SCALE FACTOR, V <sub>OUT</sub> /I <sub>SENSE</sub> (V/A)
0.1	1000	3.48	3.48	34.8
1	100	3.48	3.48	3.48
5	20	3.48	3.48	0.696
10	10	3.48	3.48	0.348

- Accuracy:** A high R<sub>SENSE</sub> value allows lower currents to be measured more accurately. This is because offsets become less significant when the sense voltage is larger. For best performance, select R<sub>SENSE</sub> to provide approximately 100mV of sense voltage for the full-scale current in each application.
- Efficiency and Power Dissipation:** At high current levels, the I<sup>2</sup>R losses in R<sub>SENSE</sub> can be significant. Take this into consideration when choosing the resistor value and its power dissipation (wattage) rating. Also, the sense resistor's value might drift if it is allowed to heat up excessively.
- Inductance:** Keep inductance low if I<sub>SENSE</sub> has a large high-frequency component. Wire-wound resistors have the highest inductance, while metal film is somewhat better. Low-inductance metal-film resistors are also available. Instead of being spiral wrapped around a core, as in metal-film or wire-wound resistors, they are a straight band of metal and are available in values under 1Ω.
- Cost:** If the cost of R<sub>SENSE</sub> is an issue, you might want to use an alternative solution, as shown in Figure 2. This solution uses the PC board traces to create a sense resistor. Because of the inaccuracies of the copper resistor, the full-scale current value must be adjusted with a potentiometer. Also, copper's resistance temperature coefficient is fairly high (approximately 0.4%/°C).

In Figure 2, assume that the load current to be measured is 10A, and that you have determined a 0.3-inch-wide, 2-ounce copper to be appropriate. The resistivity of 0.1-inch-wide, 2-ounce (70μm thickness) copper is 30mΩ/ft. For 10A, you might want R<sub>SENSE</sub> = 5mΩ for a 50mV drop at full scale. This resistor requires about 2 inches of 0.1-inch-wide copper trace.

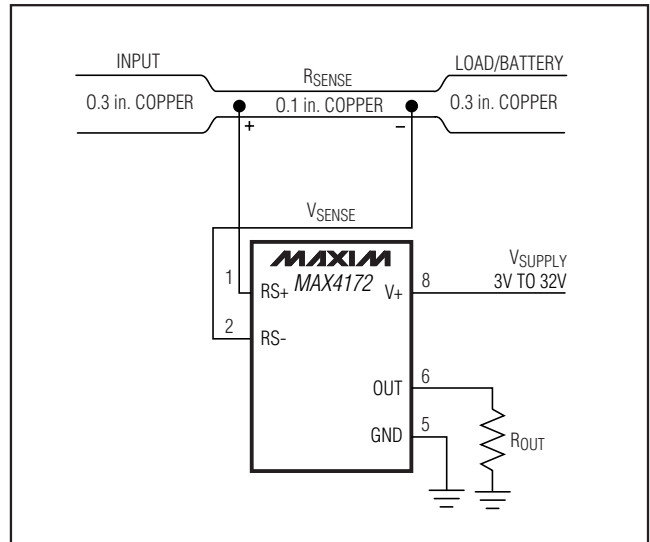

Figure 2. MAX4172 Connections Showing Use of PC Board

### Current-Sense Adjustment (Resistor Range, Output Adjust)

Choose R<sub>OUT</sub> after selecting R<sub>SENSE</sub>. Choose R<sub>OUT</sub> to obtain the full-scale voltage you require, given the full-scale I<sub>OUT</sub> determined by R<sub>SENSE</sub>. OUT's high impedance permits using R<sub>OUT</sub> values up to 200kΩ with minimal error. OUT's load impedance (e.g., the input of an op amp or ADC) must be much greater than R<sub>OUT</sub> (e.g., 100 x R<sub>OUT</sub>) to avoid degrading measurement accuracy.

### High-Current Measurement

The MAX4172 can achieve high-current measurements by using low-value sense resistors, which can be paralleled to further increase the current-sense limit. As an alternative, PC board traces can be adjusted over a wide range.

# Low-Cost, Precision, High-Side Current-Sense Amplifier

## Power-Supply Bypassing and Grounding

In most applications, grounding the MAX4172 requires no special precautions. However, in high-current systems, large voltage drops can develop across the ground plane, which can add to or subtract from  $V_{OUT}$ . Use a single-point star ground for the highest current-measurement accuracy.

The MAX4172 requires no special bypassing and responds quickly to transient changes in line current. If the noise at OUT caused by these transients is a problem, you can place a  $1\mu\text{F}$  capacitor at the OUT pin to ground. You can also place a large capacitor at the RS terminal (or load side of the MAX4172) to decouple the load, reducing the current transients. These capacitors are not required for MAX4172 operation or stability. The RS+ and RS- inputs can be filtered by placing a capacitor (e.g.,  $1\mu\text{F}$ ) between them to average the sensed current.

## Chip Information

SUBSTRATE CONNECTED TO GND

## Package Information

For the latest package outline information and land patterns, go to [www.maxim-ic.com/packages](http://www.maxim-ic.com/packages). Note that a "+", "#", or "-" in the package code indicates RoHS status only. Package drawings may show a different suffix character, but the drawing pertains to the package regardless of RoHS status.

PACKAGE TYPE	PACKAGE CODE	OUTLINE NO.	LAND PATTERN NO.
SO	S8+4	<a href="#">21-0042</a>	<a href="#">90-0096</a>
$\mu\text{MAX}$	U8+1	<a href="#">21-0036</a>	<a href="#">90-0092</a>



# Low-Cost, Precision, High-Side Current-Sense Amplifier

## Revision History

REVISION NUMBER	REVISION DATE	DESCRIPTION	PAGES CHANGED
0	12/96	Initial release	—
1	6/10	Clarified 0V to 2V is not a high-accuracy range for the device, removed future product reference, added lead-free options and soldering temperature	1, 2

MAX4172

Maxim cannot assume responsibility for use of any circuitry other than circuitry entirely embodied in a Maxim product. No circuit patent licenses are implied. Maxim reserves the right to change the circuitry and specifications without notice at any time.

Maxim Integrated Products, 120 San Gabriel Drive, Sunnyvale, CA 94086 408-737-7600 \_\_\_\_\_ 9

© 2010 Maxim Integrated Products

Maxim is a registered trademark of Maxim Integrated Products, Inc.