

 EVALUATION KIT  
AVAILABLE

# 3V/5V Low-Power, Low-Noise, CMOS, Rail-to-Rail I/O Op Amps

## General Description

The MAX9636/MAX9637/MAX9638 are single-supply, CMOS input op amps featuring wide bandwidth at low quiescent current, making them suitable for a broad range of battery-powered applications such as portable medical instruments, portable media players, and smoke detectors. A combination of extremely low input bias currents, low input current noise and low input voltage noise allows interface to high-impedance sources such as photodiode and piezoelectric sensors. These devices are also ideal for general-purpose signal processing functions such as filtering and amplification in a broad range of portable, battery-powered applications.

The ICs feature a maximized ratio of gain bandwidth (GBW) to supply current. The devices operate from a single 2.1V to 5.5V supply at a typical quiescent supply current of 36 $\mu$ A. For additional power conservation, the MAX9636 and MAX9638 offer a low-power shutdown mode that reduces supply current to 1 $\mu$ A and places the amplifiers' outputs into a high-impedance state.

The ICs are specified over the automotive operating temperature range (-40°C to +125°C). The single is offered in a space-saving, 6-pin SC70 package, while the dual is offered in tiny, 8-pin SC70 and 10-pin UTQFN packages.

## Applications

- Portable Medical Instruments
- Piezoelectric Transducer Amplifiers
- Smoke Detectors
- Battery-Powered Devices
- General-Purpose Signal Conditioning
- Notebooks
- Portable Media Players

## Features

- ◆ Low Input Voltage-Noise Density: 38nV/ $\sqrt{\text{Hz}}$
- ◆ Low Input Current-Noise Density: 0.9fA/ $\sqrt{\text{Hz}}$
- ◆ Ultra-Low 0.1pA Bias Current
- ◆ Low 36 $\mu$ A Quiescent Current
- ◆ 1 $\mu$ A Quiescent Current in Shutdown
- ◆ Wide 1.5MHz Bandwidth
- ◆ Single-Supply Operation  $V_{DD} = 2.1\text{V to } 5.5\text{V}$
- ◆ Available in Tiny 6-Pin SC70, 8-Pin SC70, and 10-Pin UTQFN Packages
- ◆ -40°C to +125°C Operating Temperature Range

## Ordering Information

PART	TEMP RANGE	PIN-PACKAGE
MAX9636AXT+	-40°C to +125°C	6 SC70
MAX9637AXA+	-40°C to +125°C	8 SC70
MAX9638AVB+	-40°C to +125°C	10 UTQFN

+Denotes a lead(Pb)-free/RoHS-compliant package.

T = Tape and reel.

MAX9636/MAX9637/MAX9638

# 3V/5V Low-Power, Low-Noise, CMOS, Rail-to-Rail I/O Op Amps

## ABSOLUTE MAXIMUM RATINGS

V <sub>DD</sub> , $\overline{\text{SHDN}}$ to V <sub>SS</sub> .....	-0.3V to +6V	8-Pin SC70 (derate 3.1mW/°C above +70°C).....	245mW
IN+, IN-, OUT .....	GND - 0.3V to V <sub>DD</sub> + 0.3V	θ <sub>JA</sub> .....	326°C/W
Continuous Input Current (any pins).....	±20mA	θ <sub>JC</sub> .....	115°C/W
Output Short Circuit to V <sub>DD</sub> or V <sub>SS</sub> Duration .....	5s	10-Pin UTQFN (derate 7mW/°C above +70°C).....	558.7mW
Thermal Limits (Note 1)		θ <sub>JA</sub> .....	143.2°C/W
Multiple Layer PCB		θ <sub>JC</sub> .....	20.1°C/W
Continuous Power Dissipation (T <sub>A</sub> = +70°C)		Operating Temperature Range .....	-40°C to +125°C
6-Pin SC70 (derate 3.1mW/°C above +70°C) .....	245mW	Junction Temperature .....	+150°C
θ <sub>JA</sub> .....	326.5°C/W	Lead Temperature (soldering 10s) .....	+300°C
θ <sub>JC</sub> .....	115°C/W	Soldering Temperature (reflow) .....	+260°C

**Note 1:** Package thermal resistances were obtained using the method described in JEDEC specification JESD51-7, using a four-layer board. For detailed information on package thermal considerations, refer to [www.maxim-ic.com/thermal-tutorial](http://www.maxim-ic.com/thermal-tutorial).

Stresses beyond those listed under "Absolute Maximum Ratings" may cause permanent damage to the device. These are stress ratings only, and functional operation of the device at these or any other conditions beyond those indicated in the operational sections of the specifications is not implied. Exposure to absolute maximum rating conditions for extended periods may affect device reliability.

## ELECTRICAL CHARACTERISTICS

(V<sub>DD</sub> = 3.3V, V<sub>SS</sub> = 0V, V<sub>IN+</sub> = V<sub>IN-</sub> = V<sub>CM</sub> = V<sub>DD</sub>/2, R<sub>L</sub> = 10kΩ to V<sub>DD</sub>/2,  $\overline{\text{SHDN}}$  = V<sub>DD</sub>, T<sub>A</sub> = -40°C to +125°C. Typical values are at T<sub>A</sub> = +25°C, unless otherwise noted.) (Note 2)

PARAMETER	SYMBOL	CONDITIONS	MIN	TYP	MAX	UNITS
<b>DC CHARACTERISTICS</b>						
Input Voltage Range	V <sub>IN+</sub> , V <sub>IN-</sub>	Guaranteed by CMRR	V <sub>SS</sub> - 0.1		V <sub>DD</sub> + 0.1	V
Input Offset Voltage	V <sub>OS</sub>	T <sub>A</sub> = +25°C		0.01	2.2	mV
		T <sub>A</sub> = -40°C to +125°C			3.5	
Input Offset Voltage Drift (Note 3)	TCV <sub>OS</sub>	MAX9636 only			7	μV/°C
		MAX9637, MAX9638 only			10	
Input Bias Current (Note 3)	I <sub>B</sub>	T <sub>A</sub> = +25°C		±0.1	±0.8	pA
		T <sub>A</sub> = -40°C to +85°C			±50	
		T <sub>A</sub> = -40°C to +125°C			±800	
Common-Mode Rejection Ratio	CMRR	V <sub>SS</sub> < V <sub>CM</sub> < (V <sub>DD</sub> - 1.4V)	T <sub>A</sub> = +25°C	72	86	dB
			T <sub>A</sub> = -40°C to +125°C	68		
		(V <sub>SS</sub> - 0.1V) < V <sub>CM</sub> < (V <sub>DD</sub> + 0.1V)		58	77	
Open-Loop Gain	A <sub>OL</sub>	V <sub>OUT</sub> = 0.25V from rails		104	124	dB
		V <sub>OUT</sub> = 0.4V from rails, R <sub>L</sub> = 600Ω		100	120	
Output Short-Circuit Current	I <sub>SC</sub>	Short to V <sub>DD</sub>		55		mA
		Short to V <sub>SS</sub>		40		
Output Voltage Low	V <sub>OL</sub>	V <sub>OUT</sub>	R <sub>L</sub> = 10kΩ	0.014	0.03	V
			R <sub>L</sub> = 600Ω	0.044	0.08	
Output Voltage High	V <sub>OH</sub>	V <sub>DD</sub> - V <sub>OUT</sub>	R <sub>L</sub> = 10kΩ	0.019	0.04	V
			R <sub>L</sub> = 600Ω	0.057	0.1	
Output Leakage in Shutdown		SHDN = V <sub>SS</sub> , V <sub>OUT</sub> = 0V to V <sub>DD</sub> (MAX9636, MAX9638 only)		0.01	1	μA

# 3V/5V Low-Power, Low-Noise, CMOS, Rail-to-Rail I/O Op Amps

MAX9636/MAX9637/MAX9638

## ELECTRICAL CHARACTERISTICS (continued)

( $V_{DD} = 3.3V$ ,  $V_{SS} = 0V$ ,  $V_{IN+} = V_{IN-} = V_{CM} = V_{DD}/2$ ,  $R_L = 10k\Omega$  to  $V_{DD}/2$ ,  $\overline{SHDN} = V_{DD}$ ,  $T_A = -40^{\circ}C$  to  $+125^{\circ}C$ . Typical values are at  $T_A = +25^{\circ}C$ , unless otherwise noted.) (Note 2)

PARAMETER	SYMBOL	CONDITIONS	MIN	TYP	MAX	UNITS
<b>AC CHARACTERISTICS</b>						
Input Voltage Noise Density	$e_N$	$f = 1kHz$		38		$nV/\sqrt{Hz}$
Input Voltage Noise		$0.1Hz \leq f \leq 10Hz$		5		$\mu V_{P-P}$
Input Current Noise Density	$I_N$	$f = 1kHz$		0.9		$fA/\sqrt{Hz}$
Input Capacitance	$C_{IN}$			2		pF
Gain Bandwidth	GBW			1.5		MHz
Slew Rate	SR			0.9		$V/\mu s$
Capacitive Loading	$C_{LOAD}$	No sustained oscillations		300		pF
Distortion	THD	$f = 10kHz$ , $V_O = 2V_{P-P}$ , $A_V = 1V/V$		-68		dB
		$f = 10kHz$ , $V_O = 2V_{P-P}$ , $A_V = 1V/V$ , $V_{DD} = 5.5V$		-74		
Settling Time		To 0.1%, $V_{OUT} = 2V$ step, $A_V = 1V/V$		11.5		$\mu s$
Crosstalk		$f = 1kHz$ (MAX9637, MAX9638)		100		dB
		$f = 10kHz$ (MAX9637, MAX9638)		80		
<b>POWER-SUPPLY CHARACTERISTICS</b>						
Power-Supply Range	$V_{DD}$	Guaranteed by PSRR	2.1		5.5	V
Power-Supply Rejection Ratio	PSRR	$V_{IN+} = V_{IN-} = V_{SS}$ , $V_{DD} - V_{SS} = 2.1V$ to 5.5V	$T_A = +25^{\circ}C$	72	100	dB
			$T_A = -40^{\circ}C$ to $+125^{\circ}C$	69		
Quiescent Current	$I_{DD}$	Per amplifier	$T_A = +25^{\circ}C$	36	55	$\mu A$
			$T_A = -40^{\circ}C$ to $+125^{\circ}C$		60	
Shutdown Supply Current	$I_{DD\_SHDN}$	$V_{SHDN} \leq V_{IL}$ (MAX9636, MAX9638 only)			1	$\mu A$
Shutdown Input	$V_{IL}$	Over the power-supply range (MAX9636, MAX9638 only)			0.5	V
Shutdown Input	$V_{IH}$	Over the power-supply range (MAX9636, MAX9638 only)	1.4			V
Shutdown Input Bias Current (Note 3)	$I_{SHDN}$	MAX9636, MAX9638 only		1	100	nA
Turn-On Time	$t_{ON}$	$V_{SHDN} = 0V$ to 3V (MAX9636, MAX9638 only)		60		$\mu s$
Power-Up Time	$t_{UP}$	$V_{DD} = 0V$ to 3.3V		18		$\mu s$

**Note 2:** All devices are 100% production tested at  $T_A = +25^{\circ}C$ . Temperature limits are guaranteed by design.

**Note 3:** Parameter is guaranteed by design.

# 3V/5V Low-Power, Low-Noise, CMOS, Rail-to-Rail I/O Op Amps

## Typical Operating Characteristics

( $V_{DD} = 3.3V$ ,  $V_{SS} = 0V$ ,  $V_{IN+} = V_{IN-} = V_{CM} = V_{DD}/2$ ,  $R_L = 10k\Omega$  to  $V_{DD}/2$ ,  $\overline{SHDN} = V_{DD}$ ,  $T_A = -40^\circ C$  to  $+125^\circ C$ . Typical values are at  $T_A = +25^\circ C$ , unless otherwise noted.)

**OFFSET VOLTAGE HISTOGRAM**

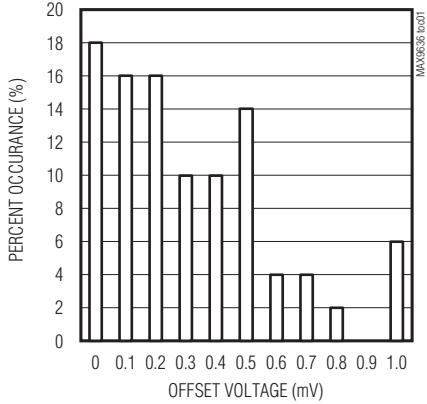

**OFFSET VOLTAGE THERMAL COEFFICIENT HISTOGRAM**

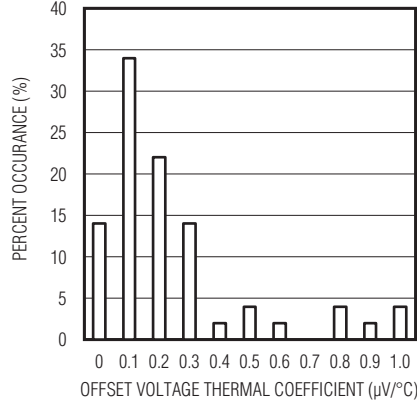

**INPUT OFFSET VOLTAGE vs. COMMON-MODE VOLTAGE**

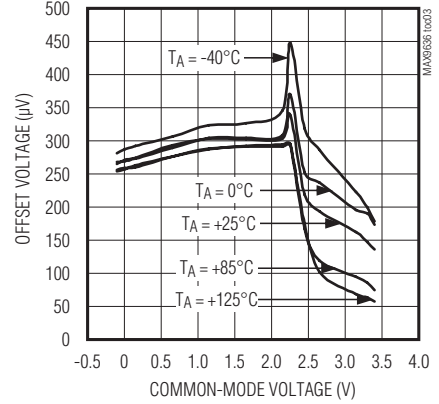

**INPUT OFFSET VOLTAGE vs. SUPPLY VOLTAGE  $V_{CM} = V_{DD}/2$**

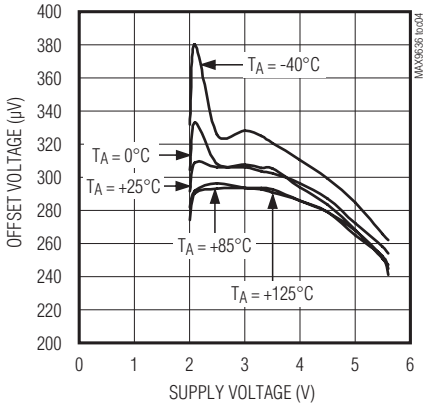

**INPUT BIAS CURRENT vs. COMMON-MODE VOLTAGE**

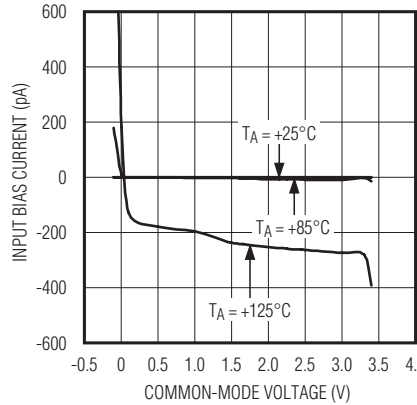

**OUTPUT VOLTAGE LOW vs. SINK CURRENT  $V_{DD} = 2.1V$**

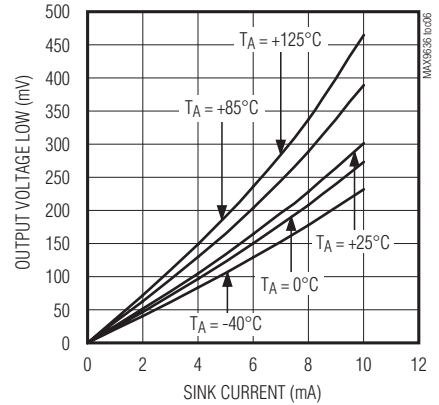

**OUTPUT VOLTAGE LOW vs. SINK CURRENT  $V_{DD} = 3.3V$**

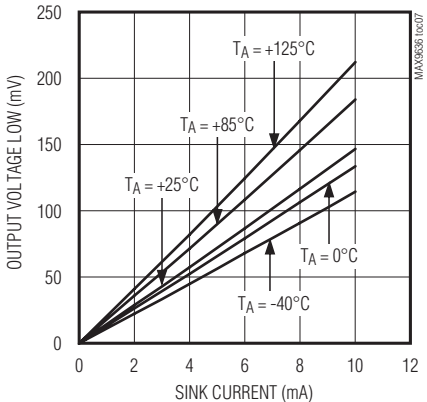

**OUTPUT VOLTAGE LOW vs. SINK CURRENT  $V_{DD} = 5V$**

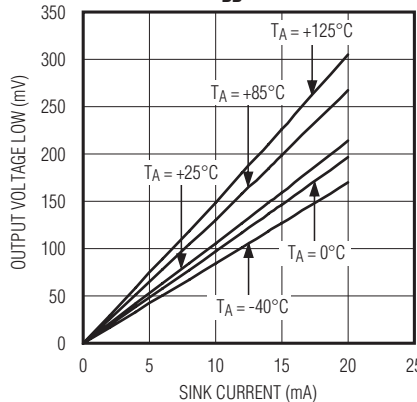

**OUTPUT VOLTAGE HIGH vs. SOURCE CURRENT  $V_{DD} = 2.1V, V_{OH} = V_{DD} - V_{OUT}$**

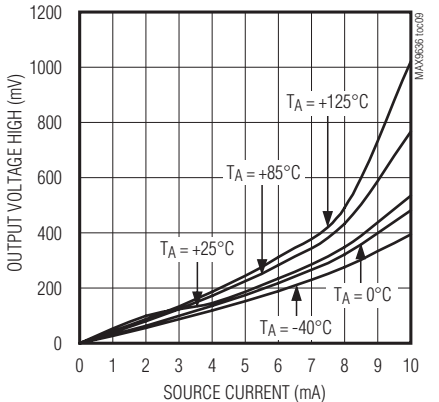

# 3V/5V Low-Power, Low-Noise, CMOS, Rail-to-Rail I/O Op Amps

MAX9636/MAX9637/MAX9638

## Typical Operating Characteristics (continued)

( $V_{DD} = 3.3V$ ,  $V_{SS} = 0V$ ,  $V_{IN+} = V_{IN-} = V_{CM} = V_{DD}/2$ ,  $R_L = 10k\Omega$  to  $V_{DD}/2$ ,  $\overline{SHDN} = V_{DD}$ ,  $T_A = -40^{\circ}C$  to  $+125^{\circ}C$ . Typical values are at  $T_A = +25^{\circ}C$ , unless otherwise noted.)

**OUTPUT VOLTAGE HIGH vs. SOURCE CURRENT**  
 $V_{DD} = 3.3V$ ,  $V_{OH} = V_{DD} - V_{OUT}$

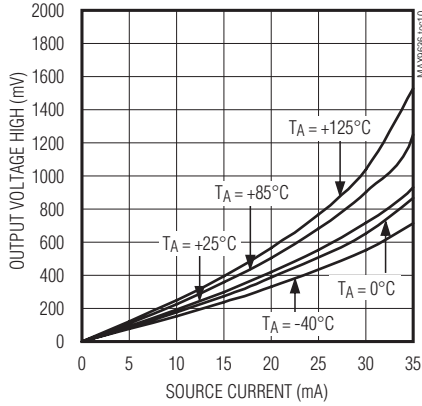

**OUTPUT VOLTAGE HIGH vs. SOURCE CURRENT**  
 $V_{DD} = 5V$ ,  $V_{OH} = V_{DD} - V_{OUT}$

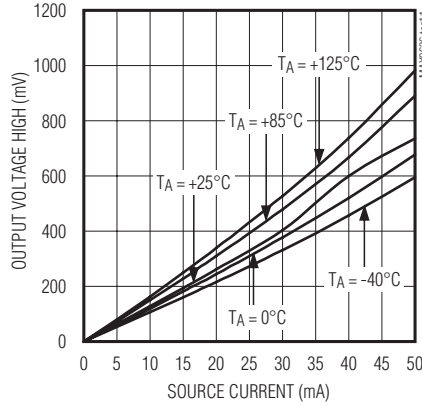

**SUPPLY CURRENT vs. SUPPLY VOLTAGE**

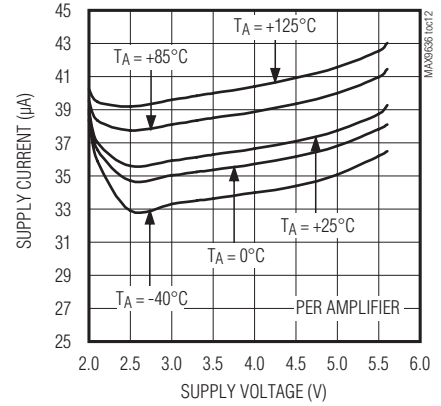

**OPEN-LOOP GAIN AND PHASE vs. FREQUENCY**

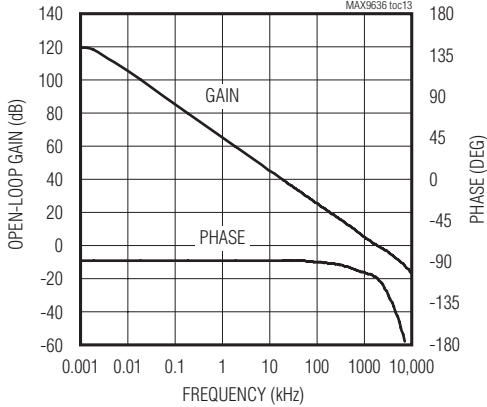

**COMMON-MODE REJECTION RATIO vs. FREQUENCY**

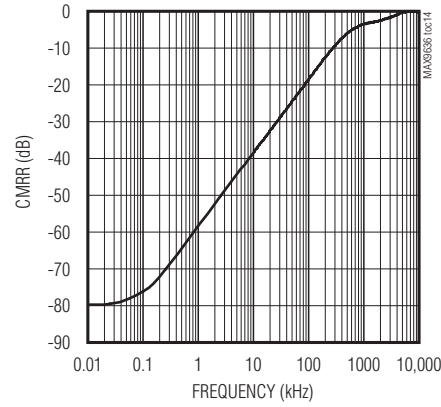

**DC COMMON-MODE REJECTION RATIO vs. TEMPERATURE**

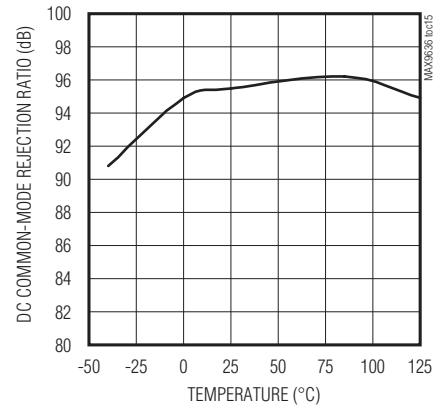

**POWER-SUPPLY REJECTION RATIO vs. FREQUENCY**

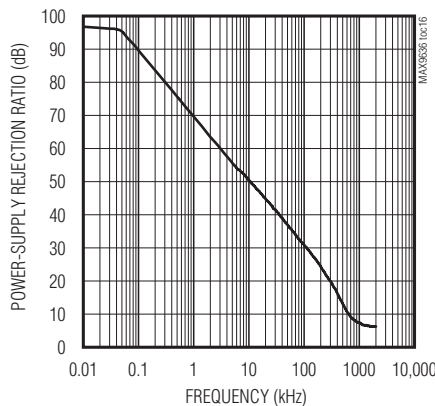

**DC POWER-SUPPLY REJECTION RATIO vs. TEMPERATURE**

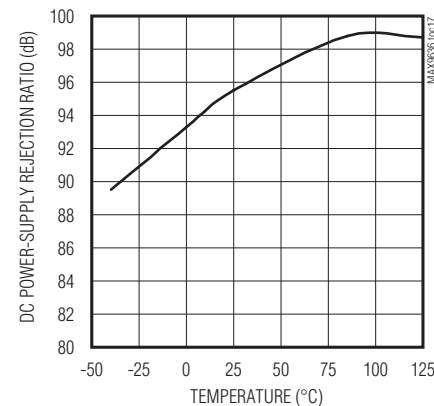

**INPUT VOLTAGE NOISE vs. FREQUENCY**

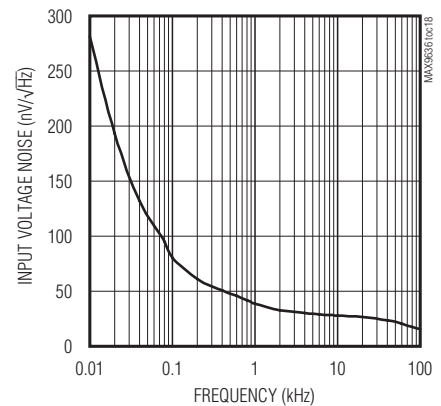

# 3V/5V Low-Power, Low-Noise, CMOS, Rail-to-Rail I/O Op Amps

## Typical Operating Characteristics (continued)

( $V_{DD} = 3.3V$ ,  $V_{SS} = 0V$ ,  $V_{IN+} = V_{IN-} = V_{CM} = V_{DD}/2$ ,  $R_L = 10k\Omega$  to  $V_{DD}/2$ ,  $\overline{SHDN} = V_{DD}$ ,  $T_A = -40^{\circ}C$  to  $+125^{\circ}C$ . Typical values are at  $T_A = +25^{\circ}C$ , unless otherwise noted.)

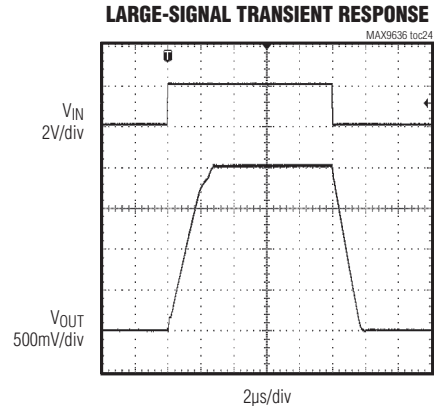
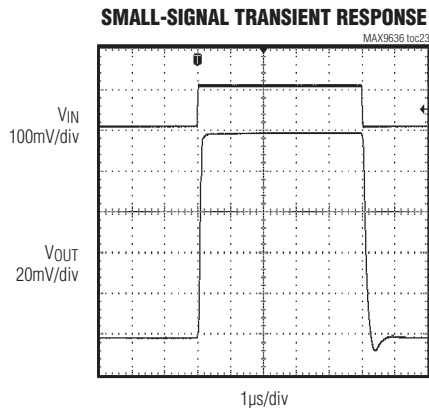
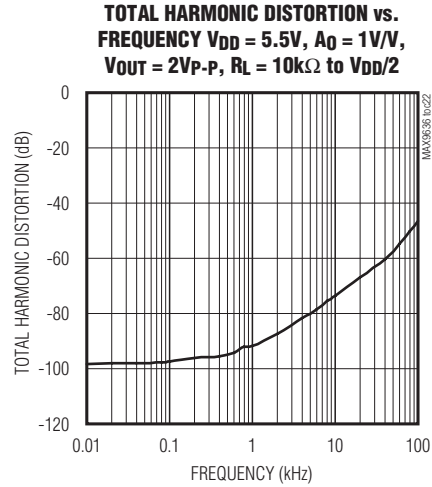
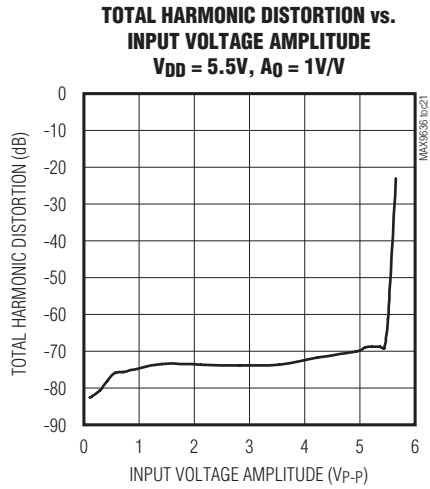
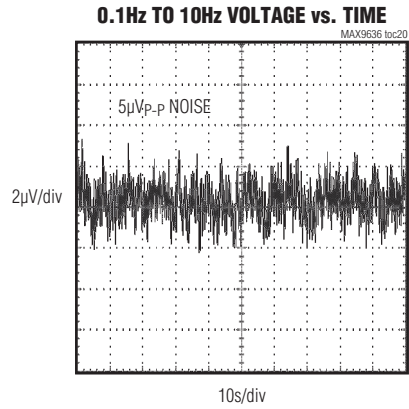
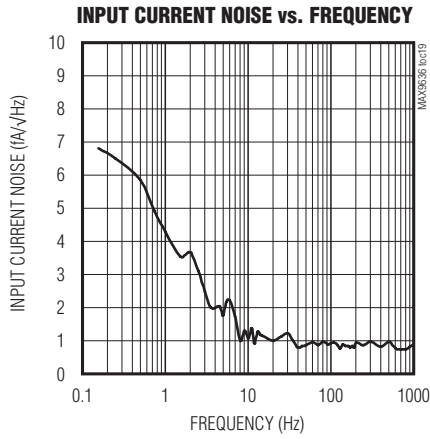

# 3V/5V Low-Power, Low-Noise, CMOS, Rail-to-Rail I/O Op Amps

## Typical Operating Characteristics (continued)

( $V_{DD} = 3.3V$ ,  $V_{SS} = 0V$ ,  $V_{IN+} = V_{IN-} = V_{CM} = V_{DD}/2$ ,  $R_L = 10k\Omega$  to  $V_{DD}/2$ ,  $\overline{SHDN} = V_{DD}$ ,  $T_A = -40^{\circ}C$  to  $+125^{\circ}C$ . Typical values are at  $T_A = +25^{\circ}C$ , unless otherwise noted.)

MAX9636/MAX9637/MAX9638

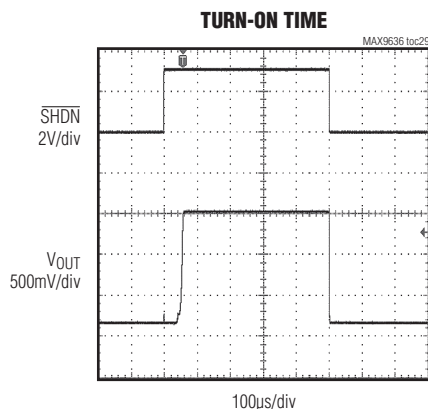
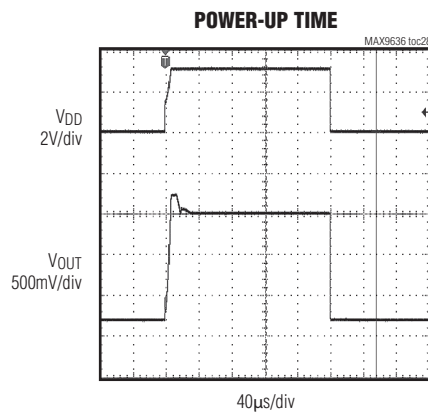
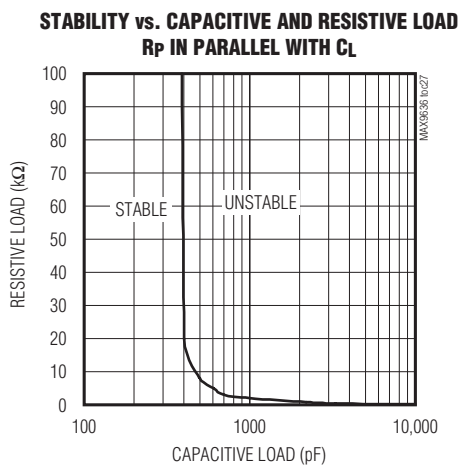
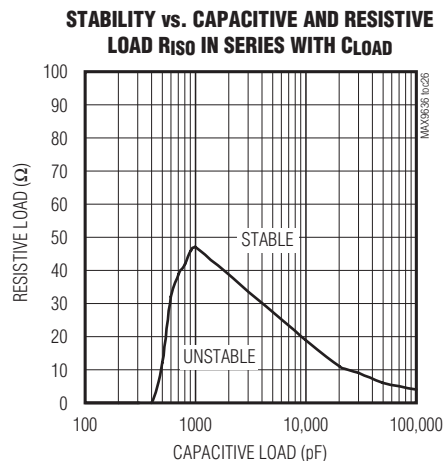
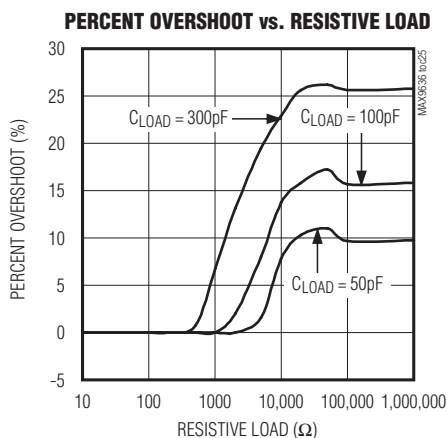

# 3V/5V Low-Power, Low-Noise, CMOS, Rail-to-Rail I/O Op Amps

## Pin Configurations

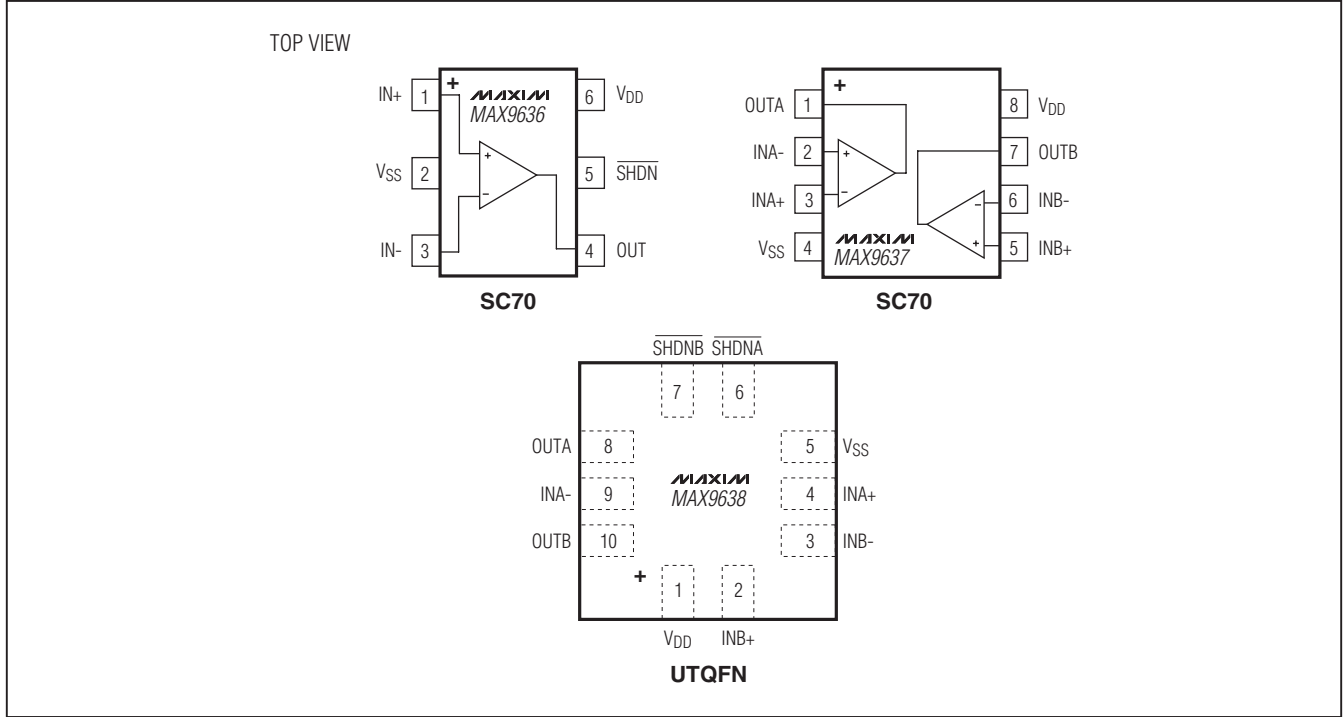

## Pin Description

PIN			NAME	FUNCTION
MAX9636 (6 SC70)	MAX9637 (8 SC70)	MAX9638 (10 UTQFN)		
1	—	—	IN+	Positive Input
—	3	4	INA+	Positive Input A
—	5	2	INB+	Positive Input B
2	4	5	VSS	Negative Power Supply. Bypass with a 0.1µF capacitor to ground.
3	—	—	IN-	Negative Input
—	2	9	INA-	Negative Input A
—	6	3	INB-	Negative Input B
4	—	—	OUT	Output
—	1	8	OUTA	Output A
—	7	10	OUTB	Output B
—	—	6	$\overline{\text{SHDNA}}$	Active-Low Shutdown A
—	—	7	$\overline{\text{SHDNB}}$	Active-Low Shutdown B
5	—	—	$\overline{\text{SHDN}}$	Active-Low Shutdown
6	8	1	VDD	Positive Power Supply. Bypass with a 0.1µF capacitor to ground.



# 3V/5V Low-Power, Low-Noise, CMOS, Rail-to-Rail I/O Op Amps

MAX9636/MAX9637/MAX9638

## Detailed Description

The MAX9636/MAX9637/MAX9638 are single-supply, CMOS input op amps. They feature wide bandwidth at low quiescent current, making them suitable for a broad range of battery-powered applications such as portable medical instruments, portable media players, and smoke detectors. A combination of extremely low input bias currents, low input current noise, and low input voltage noise allows interface to high-impedance sources such as photodiode and piezoelectric sensors. These devices are also ideal for general-purpose signal processing functions such as filtering and amplification in a broad range of portable, battery-powered applications.

The devices' operational common-mode range extends 0.1V beyond the supply rails, allowing for a wide variety of single-supply applications.

The ICs also feature low quiescent current and a shut-down mode that greatly reduces quiescent current while the device is not operational. This makes the device suitable for portable applications where power consumption must be minimized.

### Rail-to-Rail Input Stage

The operational amplifiers have parallel-connected n- and p-channel differential input stages that combine to accept a common-mode range extending 100mV beyond the supply rails. The n-channel stage is active for common-mode input voltages typically greater than ( $V_{DD} - 1.2V$ ), and the p-channel stage is active for common-mode input voltages typically less than ( $V_{DD} - 1.4V$ ). A small transition region exists, typically  $V_{DD} - 1.4$  to  $V_{DD} - 1.2V$ , during which both pairs are on.

### Rail-to-Rail Output Stage

The maximum output voltage swing is load dependent. However, it is guaranteed to be within 100mV of the positive rail even with 3mA of load current. To maximize the output current sourcing capability, these parts do not come with built-in short-circuit protection. If loads heavier than  $600\Omega$  must be driven, then ensure that the maximum allowable power dissipation is not exceeded (see the *Absolute Maximum Ratings* section).

### Low Input Bias Current

This op-amp family features ultra-low 0.1pA (typ) input bias current and guaranteed maximum current of  $\pm 50pA$  over  $-40^{\circ}C$  to  $+85^{\circ}C$  when the input common-mode voltage is at midrail. For the  $-40^{\circ}C$  to  $+85^{\circ}C$  temperature range, the variation in the input bias current is small with changes in the input voltage due to very high input impedance (in the order of  $100G\Omega$ ).

### Power-Up Time

The ICs typically require a power-up time of  $18\mu s$ . Supply settling time depends on the supply voltage, the value of the bypass capacitor, the output impedance of the incoming supply, and any lead resistance or inductance between components. Op amp settling time depends primarily on the output voltage and is slew-rate limited. The output settles in approximately  $11.5\mu s$  for  $V_{DD} = 3V$  and  $V_{OUT} = V_{DD}/2V$  (see the Power-Up Time graph in the *Typical Operating Characteristics* section).

# 3V/5V Low-Power, Low-Noise, CMOS, Rail-to-Rail I/O Op Amps

## Driving Capacitive Loads

The ICs have a high tolerance for capacitive loads. In unity-gain configuration, the op amps can typically drive up to 300pF pure capacitive load. Increasing the gain enhances the amplifier's ability to drive greater capacitive loads. In unity-gain configurations, capacitive load drive can be improved by inserting a small (5Ω to 30Ω) isolation resistor,  $R_{ISO}$ , in series with the output, as shown in Figure 1. This significantly reduces ringing while maintaining DC performance for purely capacitive loads. However, if the load also has a resistive component then a voltage-divider is created, introducing a direct current (DC) error at the output. The error introduced is proportional to the ratio  $R_{ISO}/R_L$ , which is usually negligible in most cases. Applications that cannot tolerate this slight DC error can use an alternative approach of providing stability by placing a suitable resistance in parallel with the capacitive load as shown in Figure 2 (see the *Typical Operating Characteristics* section for graphs of the stable operating region for various capacitive loads vs. resistive loads). While this approach of adding a resistor parallel to the load does not introduce DC error, it nevertheless reduces the output swing proportionally.

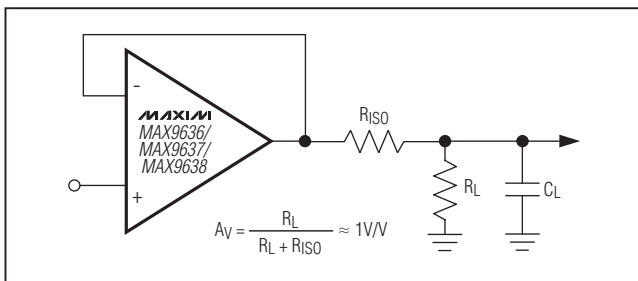

Figure 1. Using a Series Resistor to Isolate the Capacitive Load from the Op Amp

## High-Impedance Sensor Front-Ends

The ICs interface to both current-output sensors, such as photodiodes (Figure 3), and high-impedance voltage sources, such as piezoelectric sensors. For current-output sensors, a transimpedance amplifier is the most noise-efficient method for converting the input signal to a voltage. High-value feedback resistors are commonly chosen to create large gains, while feedback capacitors help stabilize the amplifier by cancelling any poles introduced in the feedback function by the highly capacitive sensor or cabling. A combination of low-current noise and low-voltage noise is important for these applications. Take care to calibrate out photodiode dark current if DC accuracy is important. The high bandwidth and slew rate also allows AC signal processing in certain medical photodiode sensor applications such as pulse oximetry.

For voltage-output sensors, a noninverting amplifier is typically used to buffer and/or apply a small gain to the input voltage signal. Due to the extremely high impedance of the sensor output, a low input bias current with minimal temperature variation is very important for these applications.

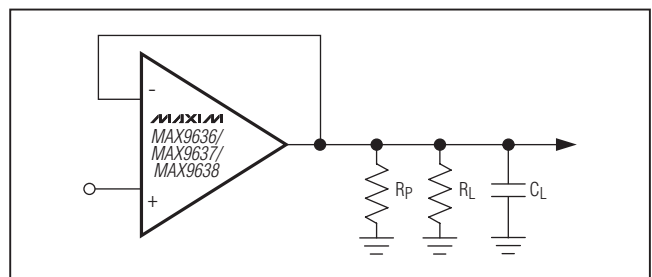

Figure 2. Using a Parallel Resistor to Degenerate the Effect of the Capacitive Load and Increase Stability

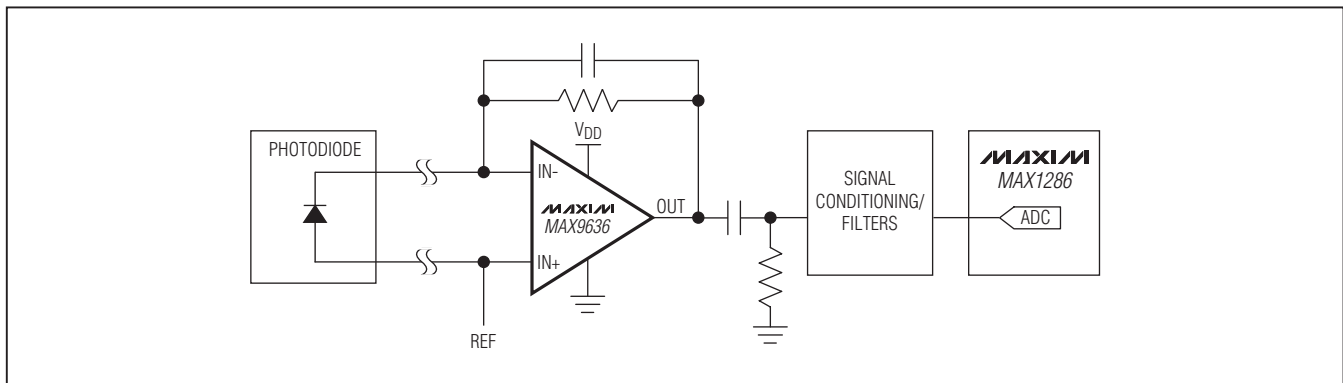

Figure 3. The MAX9636 in a Sensor Preamp Configuration

# 3V/5V Low-Power, Low-Noise, CMOS, Rail-to-Rail I/O Op Amps

MAX9636/MAX9637/MAX9638

For best performance, follow standard high-impedance layout techniques, which include the following:

- Using shielding techniques to guard against parasitic leakage paths. For example, put a trace connected to the noninverting input around the inverting input.
- Minimizing the amount of stray capacitance connected to op amp's inputs to improve stability. To achieve this, minimize trace lengths and resistor leads by placing external components as close as possible to the package.
- Use separate analog and digital power supplies.

## Applications Information

### Shutdown Operation

The MAX9636/MAX9638 feature an active-low shutdown mode that sends the inputs and output into high impedance and substantially lowers the quiescent current.

### Active-Low Input

The shutdown active-low ( $V_{IL}$ ) and high ( $V_{IH}$ ) threshold voltages are designed for ease of integration with digital controls, such as microcontroller outputs. These thresholds are independent of supply, eliminating the need for external pulldown circuitry.

### Output During Shutdown

The MAX9636/MAX9638 output is in a high-impedance state while  $\overline{SHDN}$  is low. The device structure limits the output leakage current in this state to  $0.01\mu\text{A}$  when the output is between  $0\text{V}$  to  $V_{DD}$ .

## ADC Driver

The MAX9636/MAX9637/MAX9638 are low-power amplifiers ideal for driving high to medium-resolution ADCs. Figure 3 shows how the MAX9636 is connected to a photodiode, with the amplifier output connected to additional signal conditioning/filtering, or directly to the ADC. The MAX1286–MAX1289 family of low-power, 12-bit ADCs are ideal for connecting to the MAX9636/MAX9637/MAX9638.

The MAX1286–MAX1289 ADCs offer sample rates up to 150ksps, with 3V and 5V supplies, as well as 1- and 2-channel options. These ADCs dissipate just  $15\mu\text{A}$  when sampling at 10ksps and  $0.2\mu\text{A}$  in shutdown. Offered in tiny 8-pin SOT23 and 3mm x 3mm TDFN packages, the MAX1286–MAX1289 ADCs are an ideal fit to pair with the MAX9636/MAX9637/MAX9638 amplifiers in portable applications.

Similarly, the MAX1086–MAX1089 is a family of 10-bit pin-compatible low-power ADCs with the same 3V/5V, 1- and 2-channel options. Table 1 details the amplifier and ADC pairings for single- and dual-channel applications.

## Chip Information

PROCESS: BiCMOS

**Table 1. Recommended Amplifiers/ADCs**

CHANNELS	AMPLIFIER	ADC			
		3V, 10 BIT	3V, 12 BIT	5V, 10 BIT	5V, 12 BIT
1	MAX9636	MAX1089	MAX1289	MAX1088	MAX1288
2	MAX9637	MAX1087	MAX1287	MAX1086	MAX1286
2	MAX9638	MAX1087	MAX1287	MAX1086	MAX1286

# 3V/5V Low-Power, Low-Noise, CMOS, Rail-to-Rail I/O Op Amps

## Package Information

For the latest package outline information and land patterns, go to [www.maxim-ic.com/packages](http://www.maxim-ic.com/packages). Note that a "+", "#", or "-" in the package code indicates RoHS status only. Package drawings may show a different suffix character, but the drawing pertains to the package regardless of RoHS status.

PACKAGE TYPE	PACKAGE CODE	OUTLINE NO.	LAND PATTERN NO.
6 SC70	X6SN+1	<a href="#">21-0077</a>	<a href="#">90-0189</a>
8 SC70	X8CN+1	<a href="#">21-0460</a>	<a href="#">90-0348</a>
10 UTQFN	V101A1CN+1	<a href="#">21-0028</a>	<a href="#">90-0287</a>

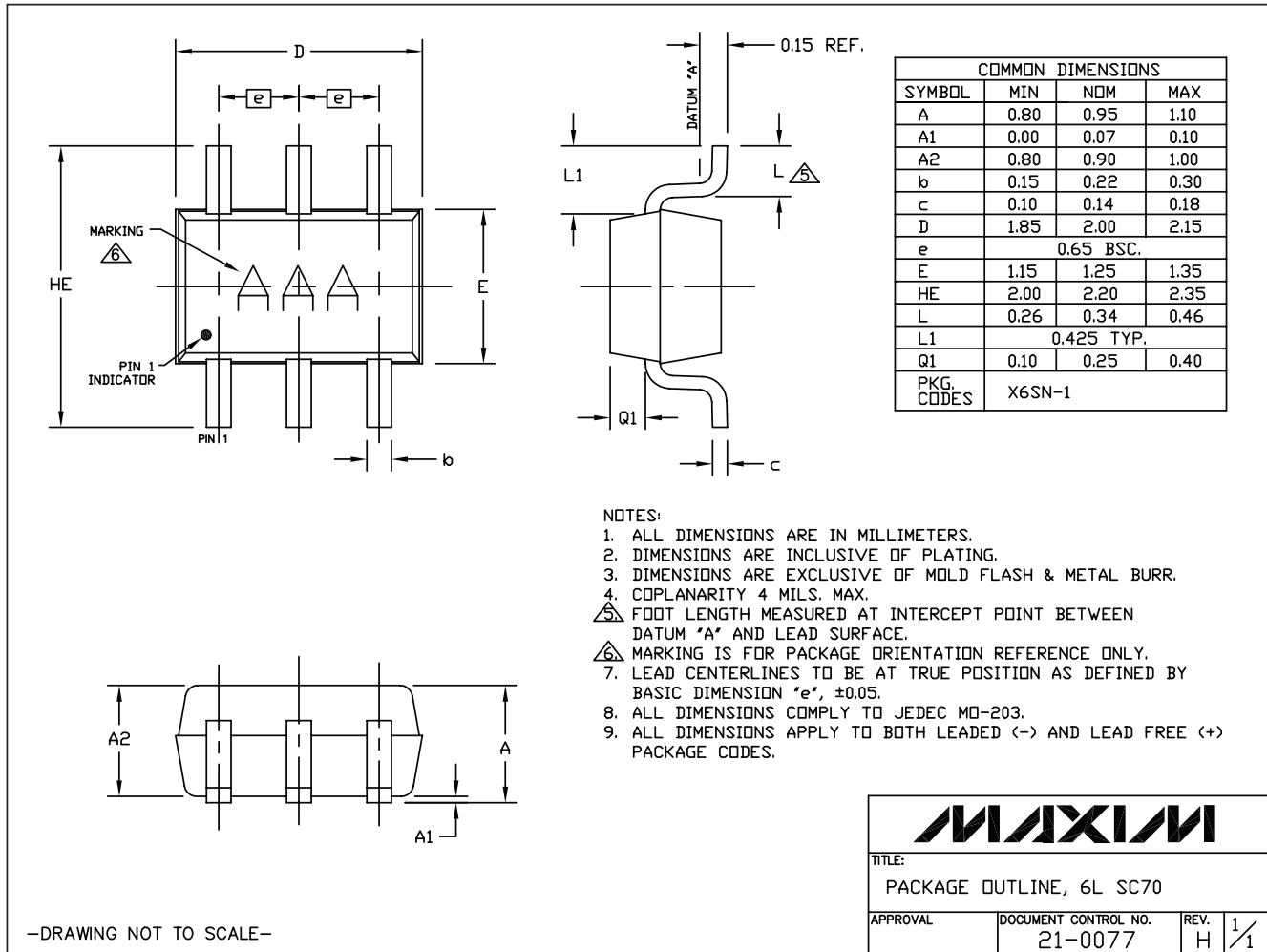

# 3V/5V Low-Power, Low-Noise, CMOS, Rail-to-Rail I/O Op Amps

## Package Information (continued)

For the latest package outline information and land patterns, go to [www.maxim-ic.com/packages](http://www.maxim-ic.com/packages). Note that a "+", "#", or "-" in the package code indicates RoHS status only. Package drawings may show a different suffix character, but the drawing pertains to the package regardless of RoHS status.

MAX9636/MAX9637/MAX9638

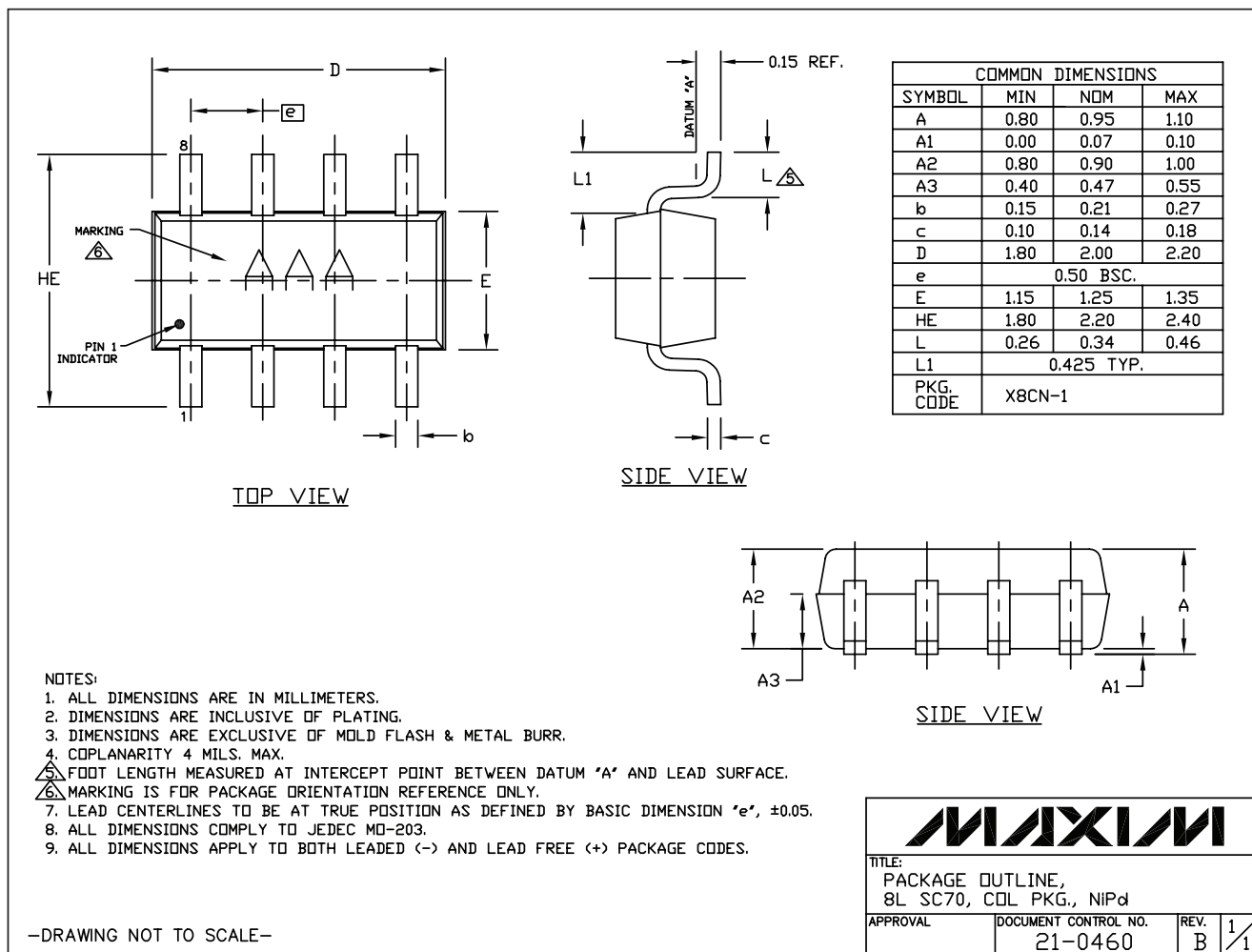

# 3V/5V Low-Power, Low-Noise, CMOS, Rail-to-Rail I/O Op Amps

## Package Information (continued)

For the latest package outline information and land patterns, go to [www.maxim-ic.com/packages](http://www.maxim-ic.com/packages). Note that a "+", "#", or "-" in the package code indicates RoHS status only. Package drawings may show a different suffix character, but the drawing pertains to the package regardless of RoHS status.

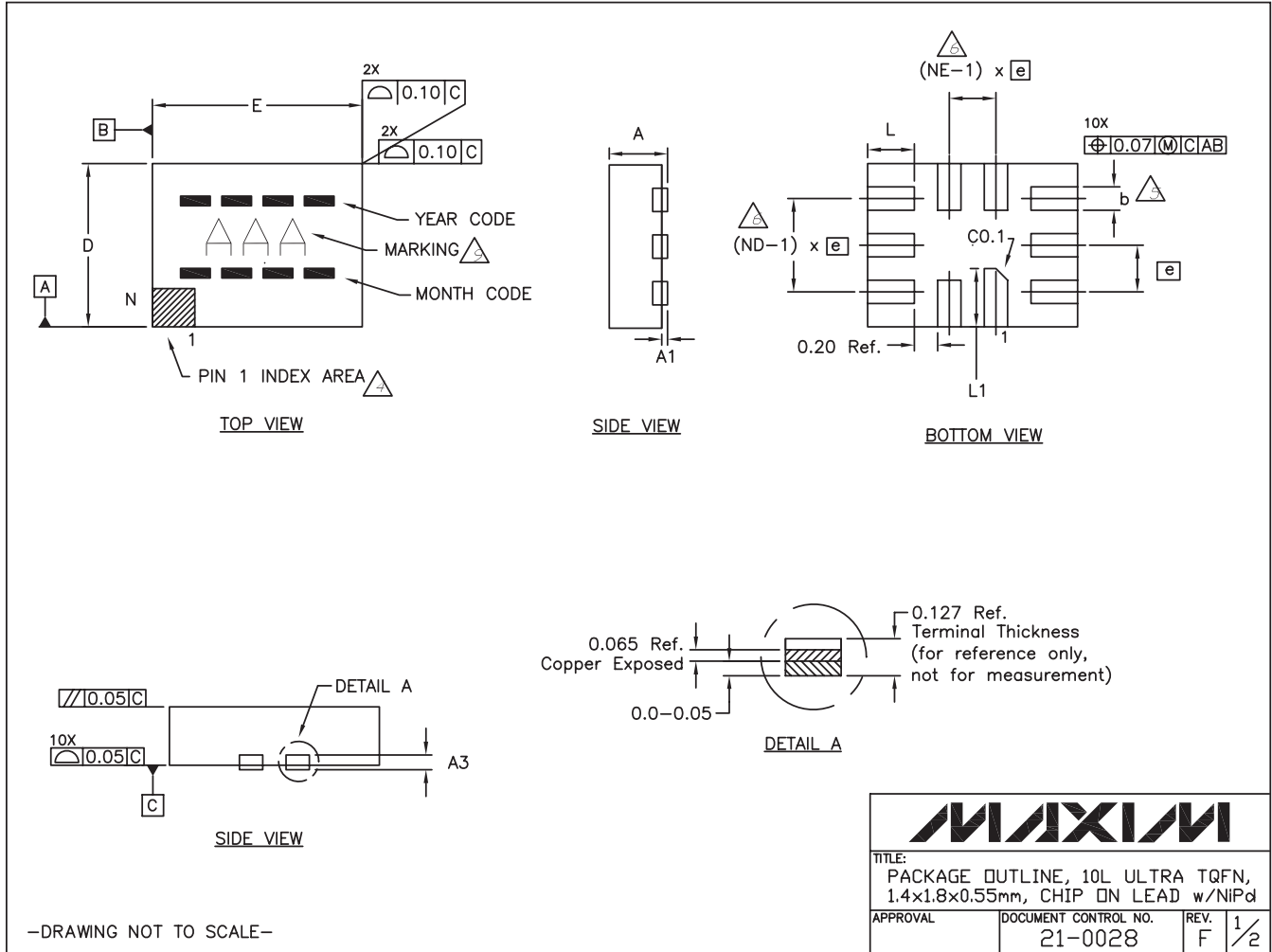

# 3V/5V Low-Power, Low-Noise, CMOS, Rail-to-Rail I/O Op Amps

## Package Information (continued)

For the latest package outline information and land patterns, go to [www.maxim-ic.com/packages](http://www.maxim-ic.com/packages). Note that a "+", "#", or "-" in the package code indicates RoHS status only. Package drawings may show a different suffix character, but the drawing pertains to the package regardless of RoHS status.

MAX9636/MAX9637/MAX9638

### NOTES:

1. DIMENSIONING & TOLERANCING CONFORM TO ASME Y14.5M-1994.
2. ALL DIMENSIONS ARE IN MILLIMETERS. ANGLES ARE IN DEGREES.
3. N IS THE TOTAL NUMBER OF TERMINALS.
4. THE TERMINAL #1 IDENTIFIER AND TERMINAL NUMBERING CONVENTION SHALL CONFORM TO JESD 95-1 SPP-012. DETAILS OF TERMINAL #1 IDENTIFIER ARE OPTIONAL, BUT MUST BE LOCATED WITHIN THE ZONE INDICATED. THE TERMINAL #1 IDENTIFIER MAY BE EITHER A MOLD OR MARKED FEATURE.
5. DIMENSION b APPLIES TO METALLIZED TERMINAL AND IS MEASURED BETWEEN 0.15mm AND 0.25mm FROM TERMINAL TIP.
6. ND AND NE REFER TO THE NUMBER OF TERMINALS ON EACH D AND E SIDE RESPECTIVELY.
7. REFER TO JEDEC MO-248 AND MO-236.
8. WARPAGE SHALL NOT EXCEED 0.05mm.
9. MARKING IS PACKAGE ORIENTATION PURPOSE ONLY.
10. DIMENSIONS APPLY TO PbFREE (+) PKG CODES ONLY.
11. COPLANARITY APPLIES TO THE EXPOSED PAD AS WELL AS THE TERMINALS. COPLANARITY SHALL NOT EXCEED 0.05mm.

PKG	10L 1.4x1.8			NOT E
REF.	MIN.	NDM.	MAX.	
A	0.45	0.50	0.55	
A1	0	-	0.05	
A3	0.127 REF			
b	0.15	0.20	0.25	
D	1.30	1.40	1.50	
E	1.70	1.80	1.90	
e	0.40 BSC.			
L	0.35	0.40	0.45	
L1	0.45	0.50	0.55	
N	10			
ND	3			
NE	2			
PKG. CODE	V101A1CN-1; V101A1CN-2			

TABLE 1

Translation Table for Calendar Year Code

2008	<input checked="" type="checkbox"/>	<input type="checkbox"/>	<input type="checkbox"/>	<input type="checkbox"/>
2009	<input checked="" type="checkbox"/>	<input type="checkbox"/>	<input type="checkbox"/>	<input checked="" type="checkbox"/>
2010	<input checked="" type="checkbox"/>	<input type="checkbox"/>	<input checked="" type="checkbox"/>	<input type="checkbox"/>
2011	<input type="checkbox"/>	<input type="checkbox"/>	<input type="checkbox"/>	<input checked="" type="checkbox"/>
2012	<input type="checkbox"/>	<input type="checkbox"/>	<input checked="" type="checkbox"/>	<input type="checkbox"/>
2013	<input type="checkbox"/>	<input type="checkbox"/>	<input checked="" type="checkbox"/>	<input checked="" type="checkbox"/>
2014	<input type="checkbox"/>	<input checked="" type="checkbox"/>	<input type="checkbox"/>	<input type="checkbox"/>
2015	<input checked="" type="checkbox"/>	<input type="checkbox"/>	<input type="checkbox"/>	<input type="checkbox"/>
2016	<input type="checkbox"/>	<input checked="" type="checkbox"/>	<input checked="" type="checkbox"/>	<input type="checkbox"/>
2017	<input type="checkbox"/>	<input checked="" type="checkbox"/>	<input checked="" type="checkbox"/>	<input checked="" type="checkbox"/>

TABLE 2

Translation Table for Calendar Month Code

Jan	<input type="checkbox"/>	<input type="checkbox"/>	<input type="checkbox"/>	<input checked="" type="checkbox"/>
Feb	<input type="checkbox"/>	<input type="checkbox"/>	<input checked="" type="checkbox"/>	<input type="checkbox"/>
Mar	<input type="checkbox"/>	<input type="checkbox"/>	<input checked="" type="checkbox"/>	<input checked="" type="checkbox"/>
Apr	<input type="checkbox"/>	<input checked="" type="checkbox"/>	<input type="checkbox"/>	<input type="checkbox"/>
May	<input type="checkbox"/>	<input checked="" type="checkbox"/>	<input checked="" type="checkbox"/>	<input checked="" type="checkbox"/>
Jun	<input type="checkbox"/>	<input checked="" type="checkbox"/>	<input checked="" type="checkbox"/>	<input type="checkbox"/>
Jul	<input type="checkbox"/>	<input checked="" type="checkbox"/>	<input checked="" type="checkbox"/>	<input checked="" type="checkbox"/>
Aug	<input checked="" type="checkbox"/>	<input type="checkbox"/>	<input type="checkbox"/>	<input type="checkbox"/>
Sep	<input checked="" type="checkbox"/>	<input type="checkbox"/>	<input type="checkbox"/>	<input checked="" type="checkbox"/>
Oct	<input checked="" type="checkbox"/>	<input type="checkbox"/>	<input checked="" type="checkbox"/>	<input type="checkbox"/>
Nov	<input checked="" type="checkbox"/>	<input type="checkbox"/>	<input checked="" type="checkbox"/>	<input checked="" type="checkbox"/>
Dec	<input checked="" type="checkbox"/>	<input checked="" type="checkbox"/>	<input type="checkbox"/>	<input type="checkbox"/>

Legend:  Marked with bar     Blank space - no bar required

-DRAWING NOT TO SCALE-

		
TITLE: PACKAGE OUTLINE, 10L ULTRA TQFN, 1.4x1.8x0.55mm, CHIP ON LEAD w/NIPd		
APPROVAL	DOCUMENT CONTROL NO. 21-0028	REV. F 2/2

# 3V/5V Low-Power, Low-Noise, CMOS, Rail-to-Rail I/O Op Amps

## Revision History

REVISION NUMBER	REVISION DATE	DESCRIPTION	PAGES CHANGED
0	6/10	Initial release	—
1	9/10	Removed future product references, updated Input Offset Voltage Drift conditions, updated Output Short-Circuit Current typ value, updated Input Current Noise Density typ value, and added Crosstalk parameter to the <i>Electrical Characteristics</i> table, modified TOCs 12, 14, 19	1, 2, 3, 5, 6
2	1/11	Corrected the MAX9637 pin configuration	8

Maxim cannot assume responsibility for use of any circuitry other than circuitry entirely embodied in a Maxim product. No circuit patent licenses are implied. Maxim reserves the right to change the circuitry and specifications without notice at any time.

16 \_\_\_\_\_ **Maxim Integrated Products, 120 San Gabriel Drive, Sunnyvale, CA 94086 408-737-7600**

© 2011 Maxim Integrated Products

Maxim is a registered trademark of Maxim Integrated Products, Inc.