

LOC	DIST	REVISIONS				
P	LTR	DESCRIPTION	DATE	DWN	APVD	
E	B	BA	NEW RELEASE	07-OCT-09	MRS	St.P

FOR FURTHER INFORMATION SEE DATA SHEET FOR
CRG SERIES-THICK FILM CHIP RESISTORS

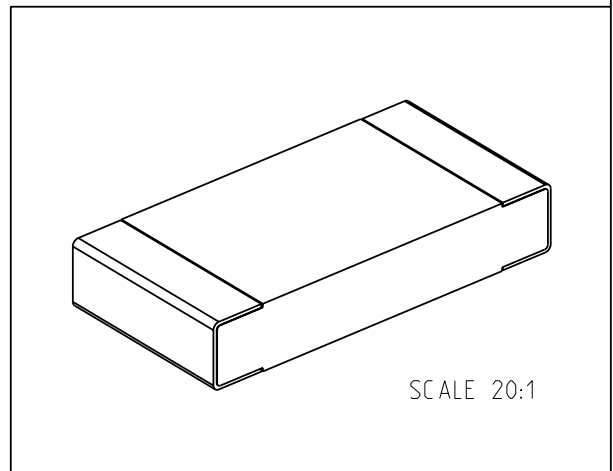
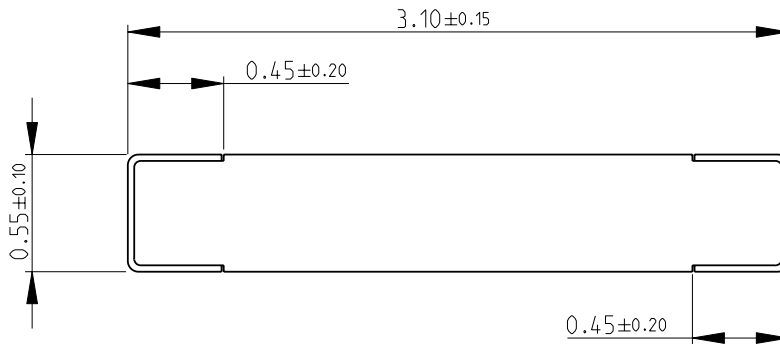
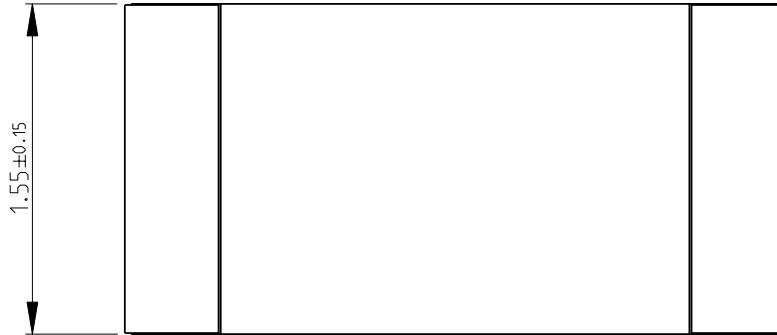

RoHS Compliant

SCALE 20:1

2009

RELEASED FOR PUBLICATION

BY TYCO ELECTRONICS CORPORATION. ALL RIGHTS RESERVED.

THIS DRAWING IS UNPUBLISHED.

© COPYRIGHT 2009

DIMENSIONS: mm TOLERANCES UNLESS OTHERWISE SPECIFIED: 0 PLC ±0.5 1 PLC ±0.2 2 PLC ±0.1 3 PLC ± 4 PLC ± ANGLES ±5°	DWN MAHARUDRA 07-OCT-09	MATERIAL -	FINISH -		
	CHK ALLAN.P 07-OCT-09	Tyco Electronics Corporation Dorcan, Swindon, SN3 5HH			
APVD STEPHEN.P 07-OCT-09	NAME THICK FILM CHIP RESISTORS SERIES CRG 1206				
PRODUCT SPEC -	APPLICATION SPEC -	SIZE A 4	CAGE CODE 00779	DRAWING NO. C= 1623405	RESTRICTED TO -
WEIGHT -	CUSTOMER DRAWING		SCALE 30:1	SHEET 1 OF 1	REV BA