

LOC	DIST	REVISIONS				
P	LTR	DESCRIPTION	DATE	DWN	APVD	
E	B	BA	NEW RELEASE	10-NOV-08	SM	St.P

FOR FURTHER INFORMATION SEE DATA SHEET FOR
CRG SERIES-THICK FILM CHIP RESISTORS

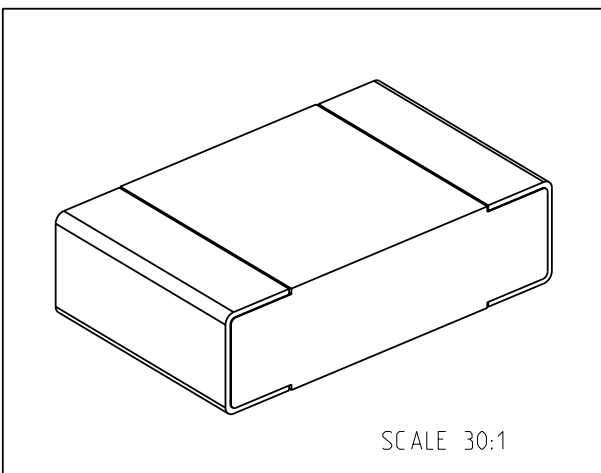
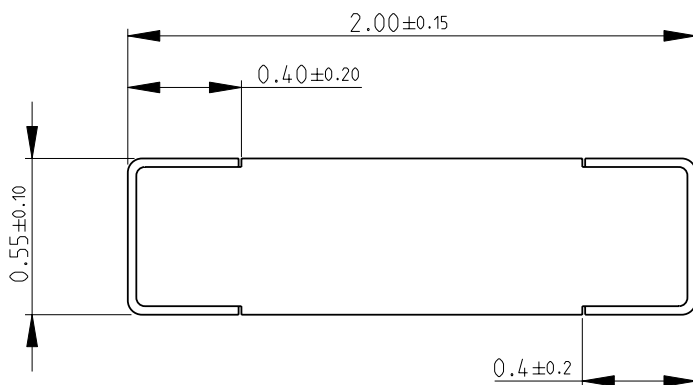

RoHS Compliant

2008

RELEASED FOR PUBLICATION

THIS DRAWING IS UNPUBLISHED.

© COPYRIGHT 2008 BY TYCO ELECTRONICS CORPORATION. ALL RIGHTS RESERVED.

DIMENSIONS: mm TOLERANCES UNLESS OTHERWISE SPECIFIED: 0 PLC ±0.5 1 PLC ±0.2 2 PLC ±0.1 3 PLC ± 4 PLC ± ANGLES ±5°	DWN SUBHASH.M	10-NOV-08	MATERIAL	-	FINISH	-
	CHK PRAKASH.S	10-NOV-08	Tyco Electronics Corporation Dorcan, Swindon, SN3 5HH			
APVD STEPHEN.P	10-NOV-08					
PRODUCT SPEC	-		NAME THICK FILM CHIP RESISTORS SERIES CRG 0805			
APPLICATION SPEC	-		SIZE	CAGE CODE	DRAWING NO	RESTRICTED TO
WEIGHT	-		A 4	00779	©= 1623101	-
CUSTOMER DRAWING			SCALE	40:1	SHEET	1 OF 1
			REV BA			