

LOC	DIST	REVISIONS				
P	LTR	DESCRIPTION	DATE	DWN	APVD	
E	B	BA	NEW RELEASE	24-Sep-08	SM	St.P

FOR FURTHER INFORMATION SEE DATA SHEET FOR
CPF SERIES-THIN FILM PRECISION CHIP RESISTORS

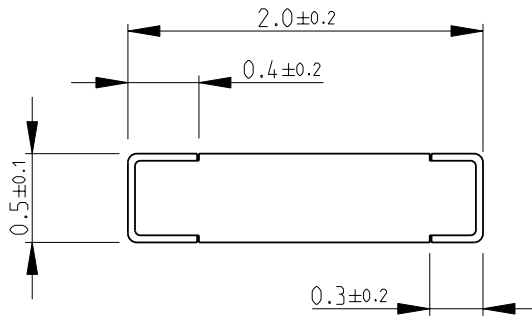

RoHS Compliant

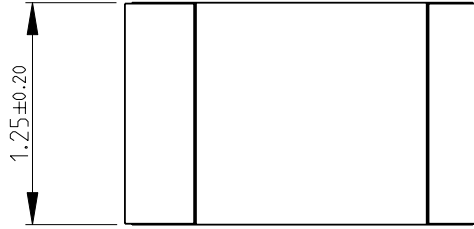
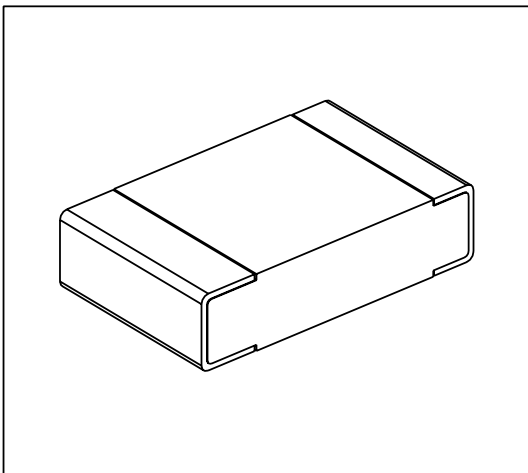

2008

RELEASED FOR PUBLICATION

THIS DRAWING IS UNPUBLISHED.

© COPYRIGHT 2008 BY TYCO ELECTRONICS CORPORATION. ALL RIGHTS RESERVED.

DIMENSIONS: mm	DWN	SUBHASH.M	24-Sep-08	MATERIAL	-	FINISH	-
	CHK	PRAKASH.S	24-Sep-08	 Tyco Electronics Corporation Dorcan, Swindon, SN3 5HH			
TOLERANCES UNLESS OTHERWISE SPECIFIED:	APVD	STEPHEN.P	24-Sep-08				
0 PLC ±0.2	PRODUCT SPEC	-	NAME	THIN FILM PRECISION CHIP RESISTORS SERIES CPF 0805			
1 PLC ±0.1	APPLICATION SPEC	-	SIZE	CAGE CODE	DRAWING NO	RESTRICTED TO	
2 PLC ±-	WEIGHT	-	A 4	00779	© = 1614931	-	
3 PLC ±-	CUSTOMER DRAWING			SCALE	25:1	SHEET	1 OF 1
4 PLC ±-						REV	BA
ANGLES ±5°							

