

LOC	DIST	REVISIONS				
P	LTR	DESCRIPTION	DATE	DWN	APVD	
E	B	BA	NEW RELEASE	23-NOV-09	MRS	St.P

FOR FURTHER INFORMATION SEE DATA SHEET FOR
CRG SERIES-THICK FILM CHIP RESISTORS

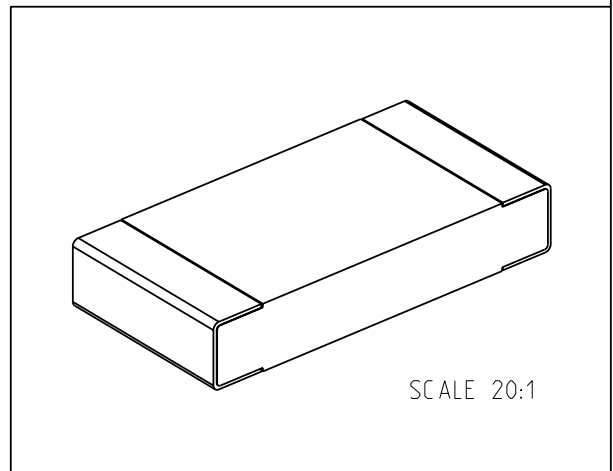
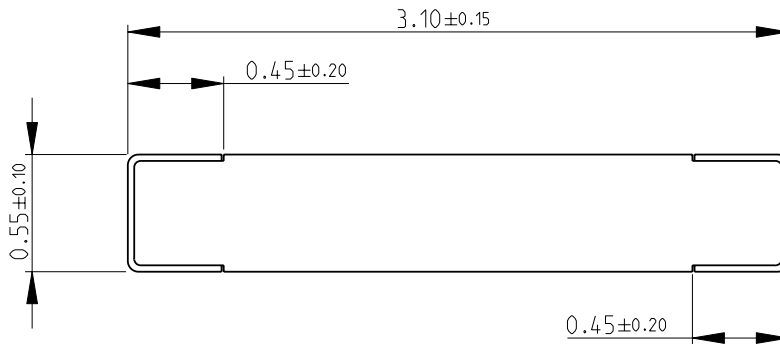
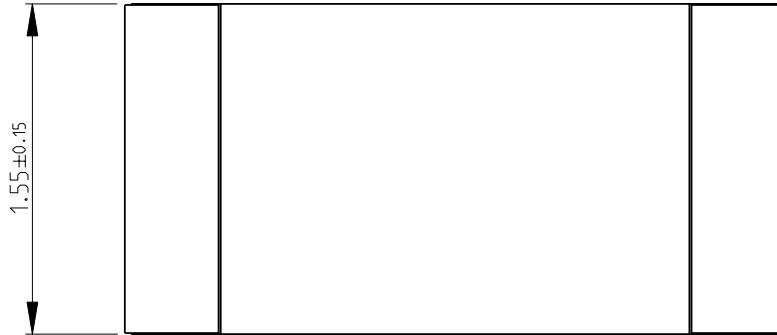

RoHS Compliant

SCALE 20:1

2009

RELEASED FOR PUBLICATION

BY TYCO ELECTRONICS CORPORATION. ALL RIGHTS RESERVED.

THIS DRAWING IS UNPUBLISHED.

© COPYRIGHT 2009

DIMENSIONS: mm	DWN MAHARUDRA	23-NOV-09	MATERIAL	-	FINISH	-
	CHK ALLAN.P	23-NOV-09	Tyco Electronics Corporation Dorcan, Swindon, SN3 5HH			
TOLERANCES UNLESS OTHERWISE SPECIFIED:	APVD STEPHEN.P	23-NOV-09				
0 PLC ±0.5	PRODUCT SPEC	-	NAME THICK FILM CHIP RESISTORS SERIES CRG 1206			
1 PLC ±0.2	APPLICATION SPEC	-	SIZE	CAGE CODE	DRAWING NO	RESTRICTED TO
2 PLC ±0.1			A 4	00779	© = 1623462	-
3 PLC ±			CUSTOMER DRAWING			
4 PLC ±	WEIGHT	-	SCALE	30:1	SHEET	1 OF 1
ANGLES ±5°			REV	BA		

