

Main Features

Symbol	Value	Unit
$I_{T(RMS)}$	0.8	A
V_{DRM}/V_{RRM}	600	V
$I_{GT(Q_1)}$	5	mA

Description

The Z00607 is suitable for low power AC switching applications. Typical applications include home appliances (electrovalve, pump, door lock, small lamp control), fan speed controllers,...

Thanks to the low gate triggering current these triacs can be driven directly by microcontrollers.

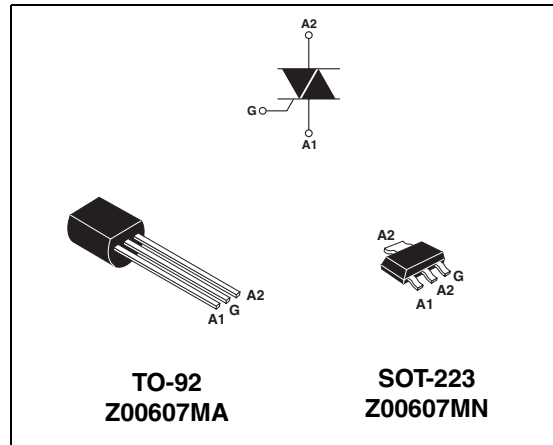
Order Codes

Part Number	Marking
Z00607MA 1BA2	Z0607MA
Z00607MA 2BL2	Z0607MA
Z00607MA 5BL2	Z0607MA
Z00607MN 5AA4	Z6M

Table 1. Absolute maximum ratings

Symbol	Parameter		Value	Unit	
$I_{T(RMS)}$	RMS on-state current (full sine wave)	SOT-223	$T_{tab} = 85^{\circ}C$	0.8	A
		TO-92	$T_L = 50^{\circ}C$		
I_{TSM}	Non repetitive surge peak on-state current (full cycle, T_j initial = $25^{\circ}C$)	F = 50 Hz	t = 20 ms	9	A
		F = 60 Hz	t = 16.7 ms	9.5	
I^2t	I^2t Value for fusing	$t_p = 10$ ms		0.45	A^2s
dl/dt	Critical rate of rise of on-state current $I_G = 2 \times I_{GT}$, $t_r \leq 100$ ns	F = 120 Hz	$T_j = 110^{\circ}C$	20	A/ μs
I_{GM}	Peak gate current	$t_p = 20$ μs	$T_j = 110^{\circ}C$	1	A
$P_{G(AV)}$	Average gate power dissipation		$T_j = 110^{\circ}C$	0.1	W
T_{stg} T_j	Storage junction temperature range Operating junction temperature range			- 40 to + 150 - 40 to + 110	$^{\circ}C$

1 Characteristics

Table 2. Electrical characteristics ($T_j = 25^\circ\text{C}$, unless otherwise specified)

Symbol	Test Conditions	Quadrant		Value	Unit
$I_{GT}^{(1)}$	$V_D = 12\text{ V}$ $R_L = 30\ \Omega$	I - II - III	MAX	5	mA
		IV		7	
V_{GT}		ALL	MAX	1.3	V
V_{GD}	$V_D = V_{DRM}$ $R_L = 3.3\text{ k}\Omega$ $T_j = 110^\circ\text{C}$	ALL	MIN	0.2	V
$I_H^{(2)}$	$I_T = 200\text{ mA}$		MX.	5	mA
I_L	$I_G = 1.2 I_{GT}$	I - III - IV	MAX	10	mA
		II		20	
$dV/dt^{(2)}$	$V_D = 67\% V_{DRM}$ gate open $T_j = 110^\circ\text{C}$		MIN	10	V/ μs
$(dV/dt)_c^{(2)}$	$(dV/dt)_c = 0.35\text{ A/ms}$ $T_j = 110^\circ\text{C}$		MIN	1.5	V/ μs

1. minimum I_{GT} is guaranteed at 5% of I_{GT} max.
2. for both polarities of A2 referenced to A1.

Table 3. Static characteristics

Symbol	Test Conditions		Value	Unit
$V_{TM}^{(1)}$	$I_{TM} = 1.1\text{ A}$ $t_p = 380\ \mu\text{s}$	$T_j = 25^\circ\text{C}$	MAX.	1.5 V
$V_{to}^{(1)}$	Threshold voltage	$T_j = 110^\circ\text{C}$	MAX.	0.95 V
$R_d^{(1)}$	Dynamic resistance	$T_j = 110^\circ\text{C}$	MAX.	420 m Ω
I_{DRM} I_{RRM}	$V_{DRM} = V_{RRM} = 600\text{ V}$	$T_j = 25^\circ\text{C}$	MAX.	5 μA
		$T_j = 110^\circ\text{C}$		0.1 mA

1. for both polarities of A2 referenced to A1.

Table 4. Thermal resistances

Symbol	Parameter	Value	Unit
$R_{th(j-t)}$	Junction to tab (AC)	SOT-223	25 $^\circ\text{C/W}$
$R_{th(j-l)}$	Junction to lead (AC)	TO-92	60 $^\circ\text{C/W}$
$R_{th(j-a)}$	Junction to ambient	$S^{(1)} = 5\text{ cm}^2$ SOT-223	60 $^\circ\text{C/W}$
		TO-92	150 $^\circ\text{C/W}$

1. S = Copper surface under tab.

Figure 1. Maximum power dissipation versus RMS on-state current (full cycle)

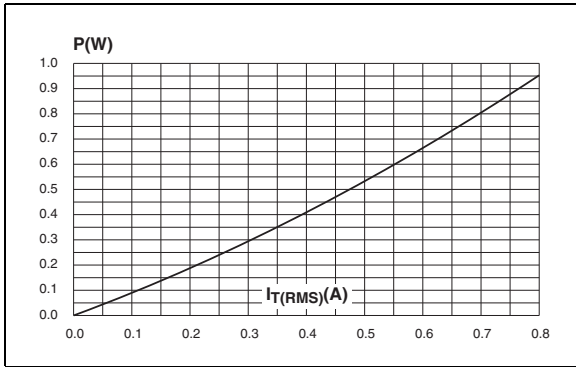

Figure 2. Relative variation of gate trigger current, holding current and latching current versus junction temperature (typical values)

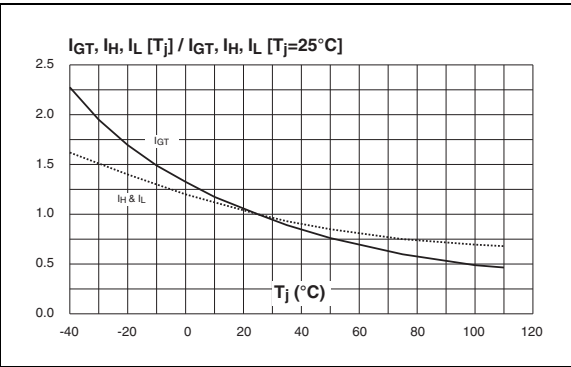

Figure 3. Surge peak on-state current versus number of cycles

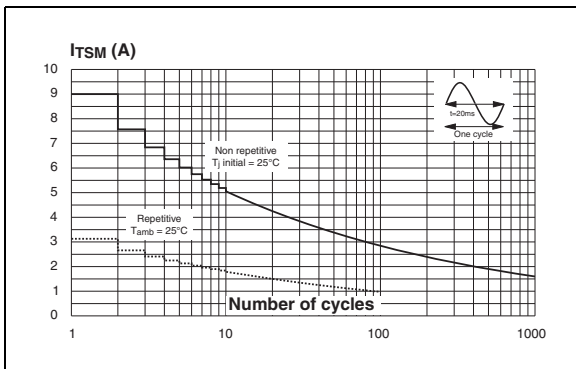

Figure 4. Non-repetitive surge peak on-state current for a sinusoidal pulse with width t_p < 10 ms and corresponding value of I^2t

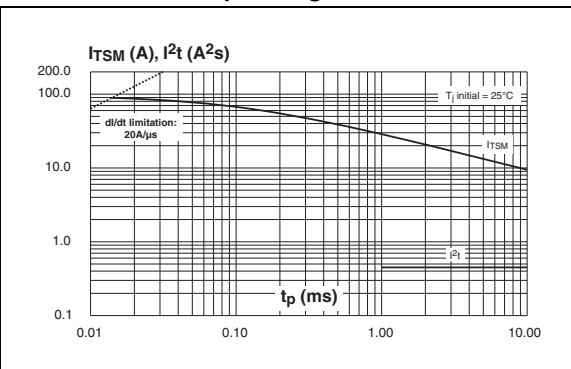

Figure 5. On-state characteristics (maximum values)

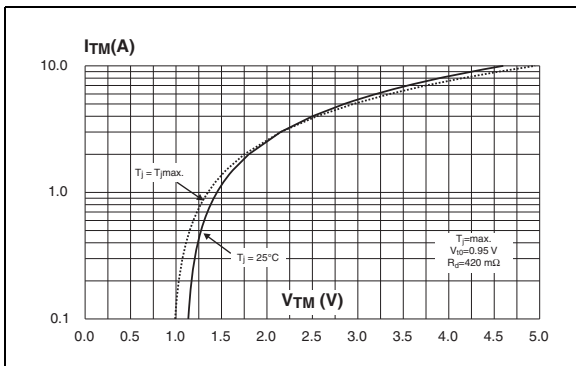

Figure 6. Relative variation of critical rate of decrease of main current versus (dV/dt)c (typical values)

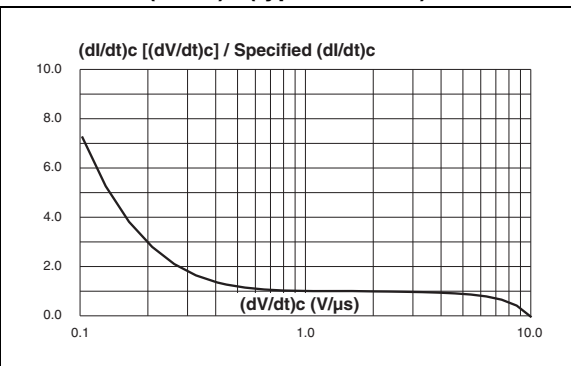

Figure 7. Relative variation of critical rate of decrease of main current versus junction temperature

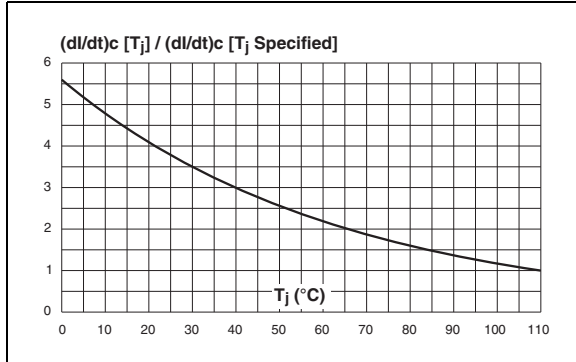
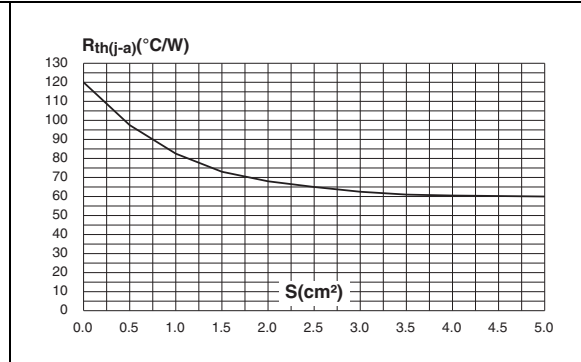
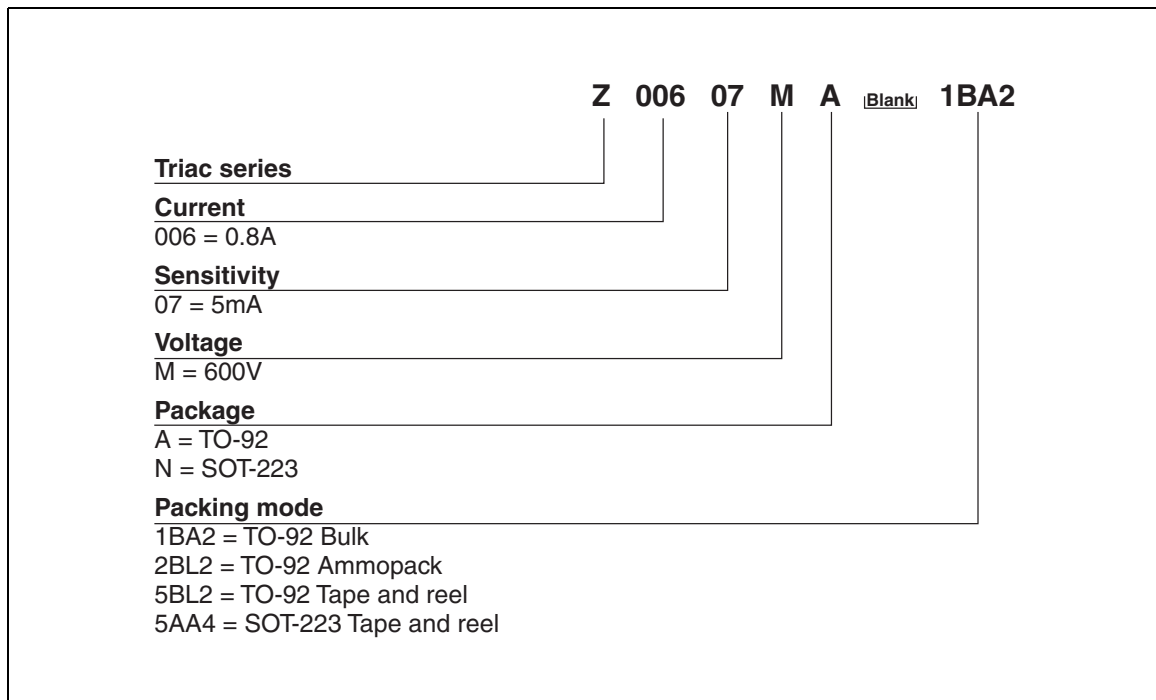

Figure 8. SOT-223 Thermal resistance junction to ambient versus copper surface under tab (printed circuit board FR4, copper thickness: 35 μm)



2 Ordering information scheme



3 Packaging information

Table 5. SOT-223 Dimensions

Ref.	Dimensions					
	Millimeters			Inches		
	Min.	Typ.	Max.	Min.	Typ.	Max.
A			1.80			0.071
A1		0.02	0.10		0.001	0.004
B	0.60	0.70	0.85	0.024	0.027	0.033
B1	2.90	3.00	3.15	0.114	0.118	0.124
c	0.24	0.26	0.35	0.009	0.010	0.014
D ⁽¹⁾	6.30	6.50	6.70	0.248	0.256	0.264
e		2.3			0.090	
e1		4.6			0.181	
E ⁽¹⁾	3.30	3.50	3.70	0.130	0.138	0.146
H	6.70	7.00	7.30	0.264	0.276	0.287
V	10° max					

1. Do not include mold flash or protrusions. Mold flash or protrusions shall not exceed 0.15mm (0.006inches)

Figure 9. Footprint (dimensions in mm)

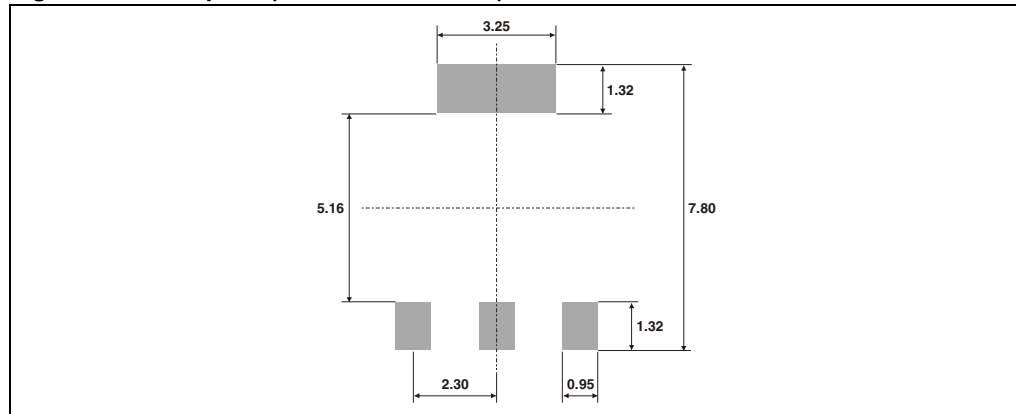

Table 6. TO-92 Dimensions

REF.	DIMENSIONS					
	Millimeters			Inches		
	Min.	Typ.	Max.	Min.	Typ.	Max.
A		1.35			0.053	
B			4.70			0.185
C		2.54			0.100	
D	4.40			0.173		
E	12.70			0.500		
F			3.70			0.146
a			0.50			0.019

4 Ordering information

Ordering type	Marking	Package	Weight	Base quantity	Delivery mode
Z00607MA 1BA2	Z0607MA	TO-92	0.2 g	2500	Bulk
Z00607MA 2BL2	Z0607MA			2000	Ammopack
Z00607MA 5BL2	Z0607MA			2000	Tape and reel
Z00607MN 5AA4	Z6M	SOT-223	0.12 g	1000	Tape and reel

5 Revision history

Date	Revision	Description of Changes
Oct-2001	4	Last update.
25-Mar-2005	5	Package: TO-92 tape and reel delivery mode 5BL2 added.
21-Jun-2005	6	Markings updated from Z006xxxx to Z06xxxx
13-Sep-2005	7	Z00607MA 2BL2: marking corrected from 00607mA to Z0607MA
12-Apr-2007	8	Reformatted to current standard. Added SOT-223 package. Changed Tj from +125 to +110 in Table 1

Please Read Carefully:

Information in this document is provided solely in connection with ST products. STMicroelectronics NV and its subsidiaries ("ST") reserve the right to make changes, corrections, modifications or improvements, to this document, and the products and services described herein at any time, without notice.

All ST products are sold pursuant to ST's terms and conditions of sale.

Purchasers are solely responsible for the choice, selection and use of the ST products and services described herein, and ST assumes no liability whatsoever relating to the choice, selection or use of the ST products and services described herein.

No license, express or implied, by estoppel or otherwise, to any intellectual property rights is granted under this document. If any part of this document refers to any third party products or services it shall not be deemed a license grant by ST for the use of such third party products or services, or any intellectual property contained therein or considered as a warranty covering the use in any manner whatsoever of such third party products or services or any intellectual property contained therein.

UNLESS OTHERWISE SET FORTH IN ST'S TERMS AND CONDITIONS OF SALE ST DISCLAIMS ANY EXPRESS OR IMPLIED WARRANTY WITH RESPECT TO THE USE AND/OR SALE OF ST PRODUCTS INCLUDING WITHOUT LIMITATION IMPLIED WARRANTIES OF MERCHANTABILITY, FITNESS FOR A PARTICULAR PURPOSE (AND THEIR EQUIVALENTS UNDER THE LAWS OF ANY JURISDICTION), OR INFRINGEMENT OF ANY PATENT, COPYRIGHT OR OTHER INTELLECTUAL PROPERTY RIGHT.

UNLESS EXPRESSLY APPROVED IN WRITING BY AN AUTHORIZED ST REPRESENTATIVE, ST PRODUCTS ARE NOT RECOMMENDED, AUTHORIZED OR WARRANTED FOR USE IN MILITARY, AIR CRAFT, SPACE, LIFE SAVING, OR LIFE SUSTAINING APPLICATIONS, NOR IN PRODUCTS OR SYSTEMS WHERE FAILURE OR MALFUNCTION MAY RESULT IN PERSONAL INJURY, DEATH, OR SEVERE PROPERTY OR ENVIRONMENTAL DAMAGE. ST PRODUCTS WHICH ARE NOT SPECIFIED AS "AUTOMOTIVE GRADE" MAY ONLY BE USED IN AUTOMOTIVE APPLICATIONS AT USER'S OWN RISK.

Resale of ST products with provisions different from the statements and/or technical features set forth in this document shall immediately void any warranty granted by ST for the ST product or service described herein and shall not create or extend in any manner whatsoever, any liability of ST.

ST and the ST logo are trademarks or registered trademarks of ST in various countries.

Information in this document supersedes and replaces all information previously supplied.

The ST logo is a registered trademark of STMicroelectronics. All other names are the property of their respective owners.

© 2007 STMicroelectronics - All rights reserved

STMicroelectronics group of companies

Australia - Belgium - Brazil - Canada - China - Czech Republic - Finland - France - Germany - Hong Kong - India - Israel - Italy - Japan - Malaysia - Malta - Morocco - Singapore - Spain - Sweden - Switzerland - United Kingdom - United States of America

www.st.com

