

LNB supply and control IC with step-up and I²C interface

Features

- Complete interface between LNB and I²C bus
- Built-in DC-DC converter for single 12 V supply operation and high efficiency (typ. 93% @ 0.5 A)
- Selectable output current limit by external resistor
- Compliant with main satellite receiver output voltage specifications
- Accurate built-in 22 kHz tone generator suits widely accepted standards
- 22 kHz tone waveform integrity guaranteed also at no load condition
- Low-drop post regulator and high efficiency step-up PWM with integrated power N-MOS allowing low power losses
- Overload and overtemperature internal protection with I²C diagnostic bits
- LNB short-circuit dynamic protection
- +/- 4 kV ESD tolerant on output power pins

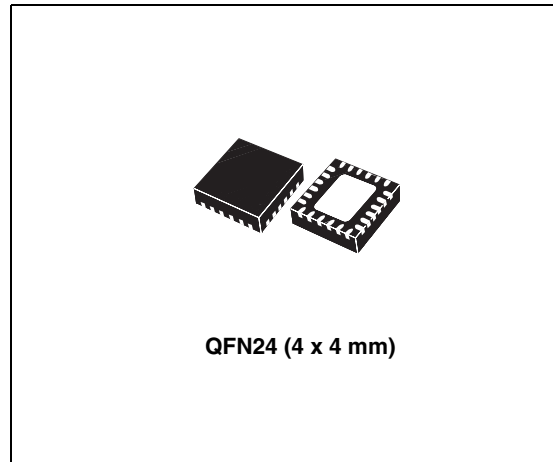

the LNB down-converter in the antenna dish or to the multi-switch box. In this application field, it offers a complete solution with extremely low component count and low power dissipation together with a simple design and I²C standard interfacing.

Applications

- STB satellite receivers
- TV satellite receivers
- PC card satellite receivers

Description

Intended for analog and digital satellite receivers/Sat-TV and Sat-PC cards, the LNBH25L is a monolithic voltage regulator and interface IC, assembled in QFN24 (4x4) specifically designed to provide the 13/18 V power supply and the 22 kHz tone signalling to

Table 1. Device summary

| Order code | Package | Packaging |
|------------|---------------|---------------|
| LNBH25LPQR | QFN24 (4 x 4) | Tape and reel |

Contents

| | | |
|----------|--|-----------|
| 1 | Block diagram | 3 |
| 2 | Application information | 4 |
| 2.1 | DiSEqC data encoding (DSQIN pin) | 4 |
| 2.2 | Data encoding by external 22 kHz tone TTL signal | 4 |
| 2.3 | Data encoding by external DiSEqC™ envelope control through the DSQIN pin | 5 |
| 2.4 | Output current limit selection | 5 |
| 2.5 | Output voltage selection | 5 |
| 2.6 | Diagnostic and protection functions | 5 |
| 2.7 | Surge protection and TVS diodes | 6 |
| 2.8 | Power-on I ² C interface reset and undervoltage lockout | 6 |
| 2.9 | PNG: input voltage minimum detection | 6 |
| 2.10 | OLF: overcurrent and short-circuit protection and diagnostic | 7 |
| 2.11 | OTF: thermal protection and diagnostic | 7 |
| 3 | Pin configuration | 8 |
| 4 | Maximum ratings | 10 |
| 5 | Typical application circuits | 11 |
| 6 | I²C bus interface | 12 |
| 6.1 | Data validity | 12 |
| 6.2 | Start and stop condition | 12 |
| 6.3 | Byte format | 12 |
| 6.4 | Acknowledge | 12 |
| 6.5 | Transmission without acknowledge | 12 |
| 7 | I²C interface protocol | 14 |
| 7.1 | Write mode transmission | 14 |
| 7.2 | Read mode transmission | 15 |
| 7.3 | Data registers | 16 |

| | | |
|-----------|---|-----------|
| 7.4 | Status registers | 18 |
| 8 | Electrical characteristics | 20 |
| 9 | Package mechanical data | 23 |
| 10 | Revision history | 27 |

1 Block diagram

Figure 1. Block diagram

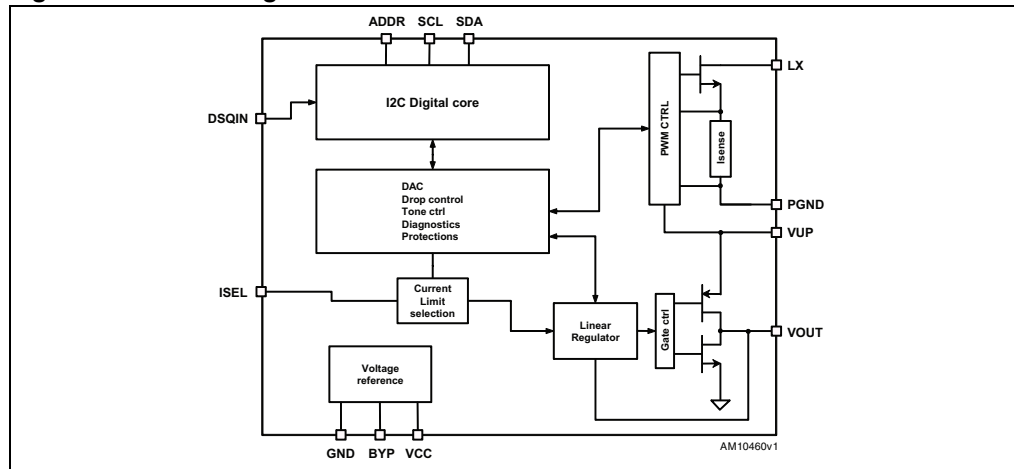

2 Application information

This IC has a built-in DC-DC step-up converter that, from a single source (8 V to 16 V), generates the voltages (V_{UP}) that let the integrated LDO post-regulator (generating the 13 V / 18 V LNB output voltages plus the 22 kHz DiSEqC™ tone) to work with a minimum dissipated power of 0.5 W typ. @ 500 mA load (the LDO drop voltage is internally kept at $V_{UP} - V_{OUT} = 1$ V typ.). The IC is also provided with an undervoltage lockout circuit that disables the whole circuit when the supplied V_{CC} drops below a fixed threshold (4.7 V typically). The step-up converter soft-start function reduces the inrush current during startup. The SS time is internally fixed at 4ms typ. to switch from 0 to 13 V and 6 ms typ. to switch from 0 to 18 V.

2.1 DiSEqC data encoding (DSQIN pin)

The internal 22 kHz tone generator is factory trimmed in accordance to DiSEqC standards, and can be activated in 3 different ways:

1. by an external 22 kHz source DiSEqC data connected to the DSQIN logic pin (TTL compatible). In this case the I²C tone control bits must be set: EXT_M = TEN = 1.
2. by an external DiSEqC data envelope source connected to the DSQIN logic pin. In this case the I²C tone control bits must be set: EXT_M=0 and TEN=1.
3. through the TEN I²C bit if a 22 kHz presence is requested in continuous mode. In this case the DSQIN TTL pin must be pulled HIGH and EXT_M bit set to "0".

2.2 Data encoding by external 22 kHz tone TTL signal

In order to improve design flexibility an external tone signal can be input to the DSQIN pin by setting the EXT_M bit to "1".

The DSQIN is a logic input pin which activates the 22 kHz tone to the V_{OUT} pin, by using the LNBH25L integrated tone generator.

The output tone waveforms are internally controlled by the LNBH25L tone generator in terms of rise/fall time and tone amplitude, while, the external 22 kHz signal on the DSQIN pin is used to define the frequency and the duty cycle of the output tone. A TTL compatible 22 kHz signal is required for the proper control of the DSQIN pin function. Before sending the TTL signal on the DSQIN pin, the EXT_M and TEN bits must be previously set to "1". As soon as the DSQIN internal circuit detects the 22 kHz TTL external signal code, the LNBH25L activates the 22 kHz tone on the V_{OUT} output with about 1 μ s delay from TTL signal activation, and it stops with about 60 μ s delay after the 22 kHz TTL signal on DSQIN has expired (refer to [Figure 2](#)).

Figure 2. Tone enable and disable timing (using external waveform)

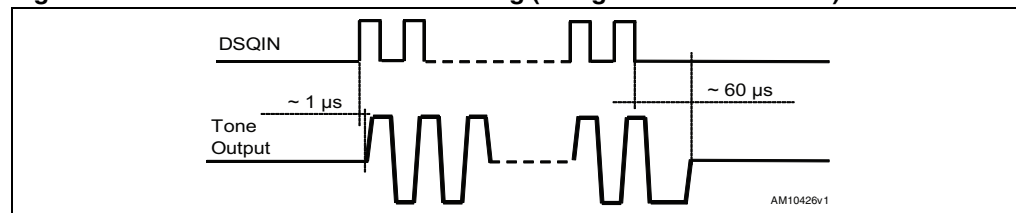

2.3 Data encoding by external DiSEqC™ envelope control through the DSQIN pin

If an external DiSEqC envelope source is available, it is possible to use the internal 22 kHz generator activated during the tone transmission by connecting the DiSEqC envelope source to the DSQIN pin. In this case the I²C tone control bits must be set: EXT_M = 0 and TEN = 1. In this way, the internal 22 kHz signal is superimposed to the V_{OUT} DC voltage to generate the LNB output 22 kHz tone. During the period in which the DSQIN is kept HIGH, the internal control circuit activates the 22 kHz tone output.

The 22 kHz tone on the V_{OUT} pin is activated with about 6 μs delay from the DSQIN TTL signal rising edge, and it stops with a delay time in the range from 15 μs to 60 μs after the 22 kHz TTL signal on DSQIN has expired (refer to [Figure 3](#)).

Figure 3. Tone enable and disable timing (using envelope signal)

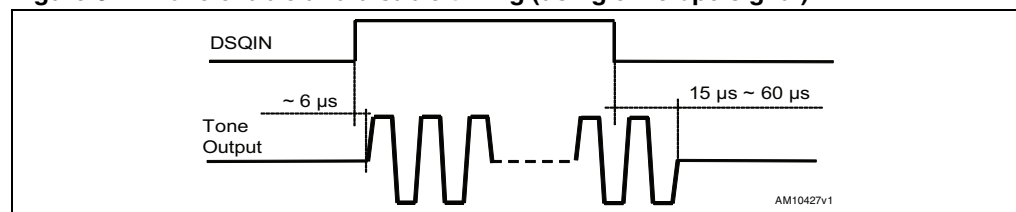

2.4 Output current limit selection

The linear regulator current limit threshold can be set by an external resistor connected to the ISEL pin. The resistor value defines the output current limit by the equation:

Equation 1

$$I_{\text{MAX}}(\text{typ.}) = \frac{13915}{\text{RSEL}^{1.111}}$$

where RSEL is the resistor connected between ISEL and GND expressed in kΩ and I_{MAX}(typ.) is the typical current limit threshold expressed in mA. I_{MAX} can be set up to 750 mA.

2.5 Output voltage selection

The linear regulator output voltage level can be easily programmed in order to accomplish application specific requirements, using 4 bits of an internal DATA1 register (see [Section 7.3](#) and [Table 13](#) for exact programmable values). Register writing is accessible via the I²C bus.

2.6 Diagnostic and protection functions

The LNBH25L has 3 diagnostic internal functions provided via the I²C bus, by reading 3 bits on the STATUS1 register (in read mode). All the diagnostic bits are, in normal operation (that is no failure detected), set to LOW. Two diagnostic bits are dedicated to the overtemperature and overload protection status (OTF and OLF). One bit is dedicated to the input voltage power not good function (PNG). Once the OLF (or OTF or PNG) bit has been activated (set to “1”), it is latched to “1” until the relevant cause is removed and a new register reading operation is done.

2.7 Surge protection and TVS diodes

The LNBH25L device is directly connected to the antenna cable in a set-top box. Atmospheric phenomenon can cause high voltage discharges on the antenna cable causing damage to the attached devices. Surge pulses occur due to direct or indirect lightning strikes to an external (outdoor) circuit. This leads to currents or electromagnetic fields causing high voltage or current transients. Transient voltage suppressor (TVS) devices are usually used, as shown in the following schematic, to protect the STB output circuits where the LNBH25L and other devices are electrically connected to the antenna cable.

Figure 4. Surge protection circuit

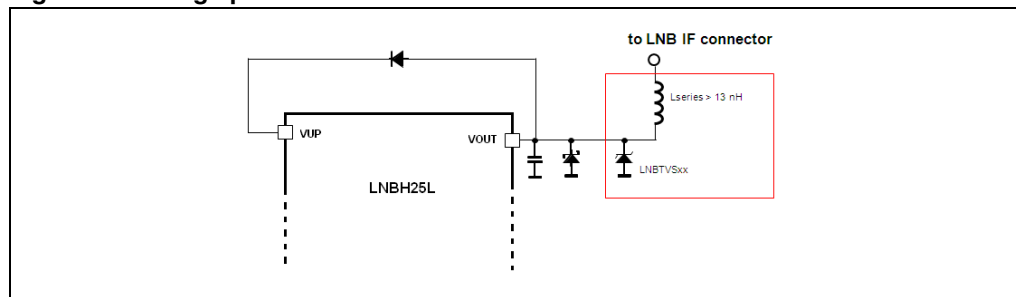

For this purpose we recommend the use of LNBTVSxx surge protection diodes specifically designed by ST. The selection of the LNBTVS diode should be made based on the maximum peak power dissipation that the diode is capable of supporting (see the LNBTVS datasheet for further details).

2.8 Power-on I²C interface reset and undervoltage lockout

The I²C interface built into the LNBH25L is automatically reset at power-on. As long as the V_{CC} stays below the undervoltage lockout (UVLO) threshold (4.7 V typ.), the interface does not respond to any I²C command and all data register bits are initialized to zeroes, therefore keeping the power blocks disabled. Once the V_{CC} rises above 4.8 V typ. the I²C interface becomes operative and the data registers can be configured by the main microprocessor.

2.9 PNG: input voltage minimum detection

When input voltage (V_{CC} pin) is lower than LPD (low power diagnostic) minimum thresholds, the PNG I²C bit is set to “1” and the FLT pin is set low. Refer to [Table 12](#) for threshold details.

2.10 OLF: overcurrent and short-circuit protection and diagnostic

In order to reduce the total power dissipation during an overload or a short-circuit condition, the device is provided with a dynamic short-circuit protection. It is possible to set the short-circuit current protection either statically (simple current clamp) or dynamically by the PCL bit of the I²C DATA3 register. When the PCL (pulsed current limiting) bit is set to LOW, the overcurrent protection circuit works dynamically: as soon as an overload is detected, the output current is provided for a T_{ON} time of 90 ms, after which the output is set in shutdown for a T_{OFF} time of typically 900 ms. Simultaneously, the diagnostic OLF I²C bit of the system register is set to "1". After this time has elapsed, the output is resumed for a time T_{ON} . At the end of T_{ON} , if the overload is still detected, the protection circuit cycles again through T_{OFF} and T_{ON} . At the end of a full T_{ON} in which no overload is detected, normal operation is resumed and the OLF diagnostic bit is reset to LOW after a register reading is done. Typical $T_{ON} + T_{OFF}$ time is 990 ms and an internal timer determines it. This dynamic operation can greatly reduce the power dissipation in a short-circuit condition, still ensuring excellent power-on startup in most conditions. However, there may be some cases in which a highly capacitive load on the output can cause a difficult startup when the dynamic protection is chosen. This can be solved by initiating any power startup in static mode (PCL=1) and then switching to the dynamic mode (PCL=0) after a chosen amount of time depending on the output capacitance. Also in static mode, the diagnostic OLF bit goes to "1" when the current clamp limit is reached and returns LOW when the overload condition is cleared and a register reading is done.

After the overload condition is removed, normal operation can be resumed in two ways, according to the OLR I²C bit on the DATA4 register.

If OLR=1, all VSEL 1..4 bits are reset to "0" and LNB output (V_{OUT} pin) is disabled. To re-enable the output stage, the VSEL bits must be set again by the microprocessor, and the OLF bit is reset to "0" after a register reading operation.

If OLR=0, output is automatically re-enabled as soon as the overload condition is removed, and the OLF bit is reset to "0" after a register reading operation.

2.11 OTF: thermal protection and diagnostic

The LNBH25L is also protected against overheating: when the junction temperature exceeds 150 °C (typ.), the step-up converter and the linear regulator are shut off, the diagnostic OTF bit in the STATUS1 register is set to "1". After the overtemperature condition is removed, normal operation can be resumed in two ways, according to the THERM I²C bit on the DATA4 register.

If THERM=1, all VSEL 1..4 bits are reset to "0" and LNB output (V_{OUT} pin) is disabled. To re-enable the output stage, the VSEL bits must be set again by the microprocessor, while the OTF bit is reset to "0" after a register reading operation.

If THERM=0, output is automatically re-enabled as soon as the overtemperature condition is removed, while the OTF bit is reset to "0" after a register reading operation.

3 Pin configuration

Figure 5. Pin connections (top view)

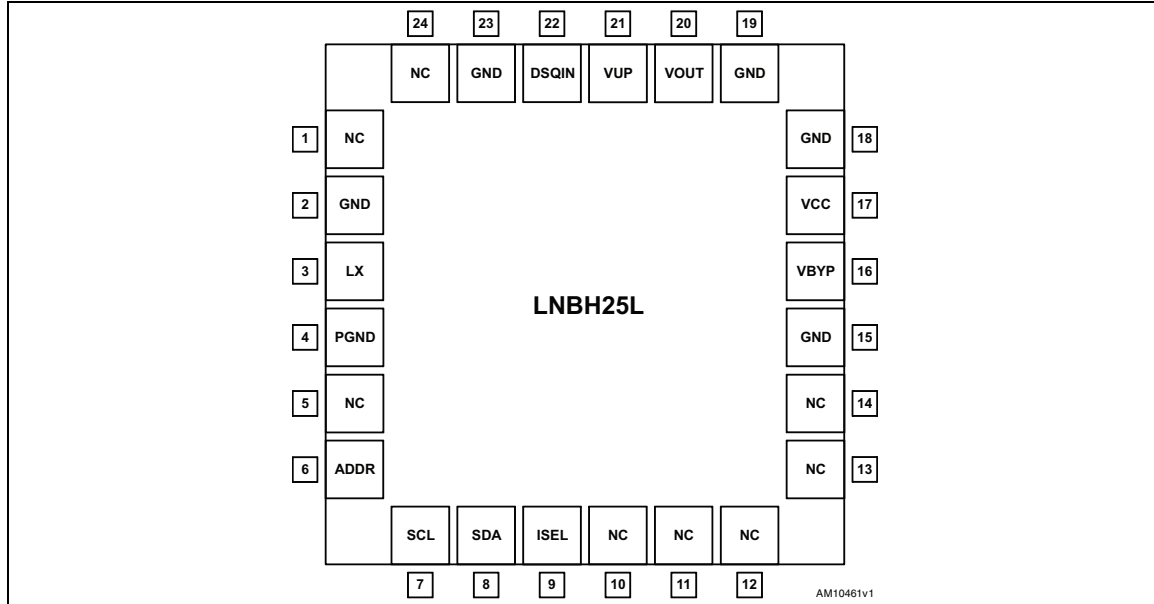

Table 2. Pin description

| Pin n° | Symbol | Name | Pin function |
|------------------|------------------|-------------------|---|
| 3 | LX | N-MOS drain | Integrated N-channel Power MOSFET drain. |
| 4 | P-GND | Power ground | DC-DC converter power ground. To be connected directly to the Epad. |
| 6 | ADDR | Address setting | Two I ² C bus addresses available by setting the address pin level voltage. See Table 15 . |
| 7 | SCL | Serial clock | Clock from I ² C bus. |
| 8 | SDA | Serial data | Bi-directional data from/to the I ² C bus. |
| 9 | ISEL | Current selection | The resistor "RSEL" connected between ISEL and GND defines the linear regulator current limit threshold. Refer to Section 2.4 . |
| 2,15, 18, 19, 23 | GND | Analog ground | Analog circuits ground. To be connected directly to the Epad. |
| 16 | BYP | Bypass capacitor | Needed for internal pre-regulator filtering. The BYP pin is intended only to connect an external ceramic capacitor. Any connection of this pin to external current or voltage sources may cause permanent damage to the device. |
| 17 | V _{CC} | Supply input | 8 to 16 V IC DC-DC power supply. |
| 20 | V _{OUT} | LNB output port | Output of the integrated very low drop linear regulator. See Table 13 for voltage selection and description. |
| 21 | V _{UP} | Step-up voltage | Input of the linear post-regulator. The voltage on this pin is monitored by the internal step-up controller to keep a minimum dropout across the linear pass transistor. |

Table 2. Pin description (continued)

| Pin n° | Symbol | Name | Pin function |
|---------------------------------|--------|--|---|
| 22 | DSQIN | DSQIN for DiSEqC envelope input or External 22 kHz TTL input | It can be used as DiSEqC envelope input or external 22 kHz TTL input depending on the EXTM I ² C bit setting as follows: EXTM=0, TEN=1: it accepts the DiSEqC envelope code from the main microcontroller. The LNBH25L uses this code to modulate the internally generated 22 kHz carrier. EXTM=TEN=1: it accepts external 22 kHz logic signals which activate the 22 kHz tone output (refer to Section 2.3). Pull up high if the tone output is activated only by the TEN I ² C bit. |
| Epad | Epad | Exposed pad | To be connected with power grounds and to the ground layer through vias to dissipate the heat. |
| 1, 5, 10, 11, 12, 13, 14, 24 | N.C. | Not internally connected | Not internally connected pins. These pins can be connected to GND to improve thermal performances. |

4 Maximum ratings

Table 3. Absolute maximum ratings

| Symbol | Parameter | Value | Unit |
|-----------|---|--------------------|------|
| V_{CC} | DC power supply input voltage pins | -0.3 to 20 | V |
| V_{UP} | DC input voltage | -0.3 to 40 | V |
| I_{OUT} | Output current | Internally limited | mA |
| V_{OUT} | DC output pin voltage | -0.3 to 40 | V |
| V_I | Logic input pins voltage (SDA, SCL, DSQIN, ADDR pins) | -0.3 to 7 | V |
| LX | LX input voltage | -0.3 to 30 | V |
| V_{BYP} | Internal reference pin voltage | -0.3 to 4.6 | V |
| ISEL | Current selection pin voltage | -0.3 to 3.5 | V |
| T_{STG} | Storage temperature range | -50 to 150 | °C |
| T_J | Operating junction temperature range | -25 to 125 | °C |
| ESD | ESD rating with human body model (HBM) all pins, unless power output pins | 2 | kV |
| | ESD rating with human body model (HBM) for power output pins | 4 | |

Table 4. Thermal data

| Symbol | Parameter | Value | Unit |
|------------|--|-------|------|
| R_{thJC} | Thermal resistance junction-case | 2 | °C/W |
| R_{thJA} | Thermal resistance junction-ambient with device soldered on 2s2p 4-layer PCB provided with thermal vias below exposed pad. | 40 | °C/W |

Note: Absolute maximum ratings are those values beyond which damage to the device may occur. These are stress ratings only and functional operation of the device at these conditions is not implied. Exposure to absolute-maximum-rated conditions for extended periods may affect device reliability. All voltage values are with respect to the network ground terminal.

5 Typical application circuits

Figure 6. DiSEqC 1.x application circuit

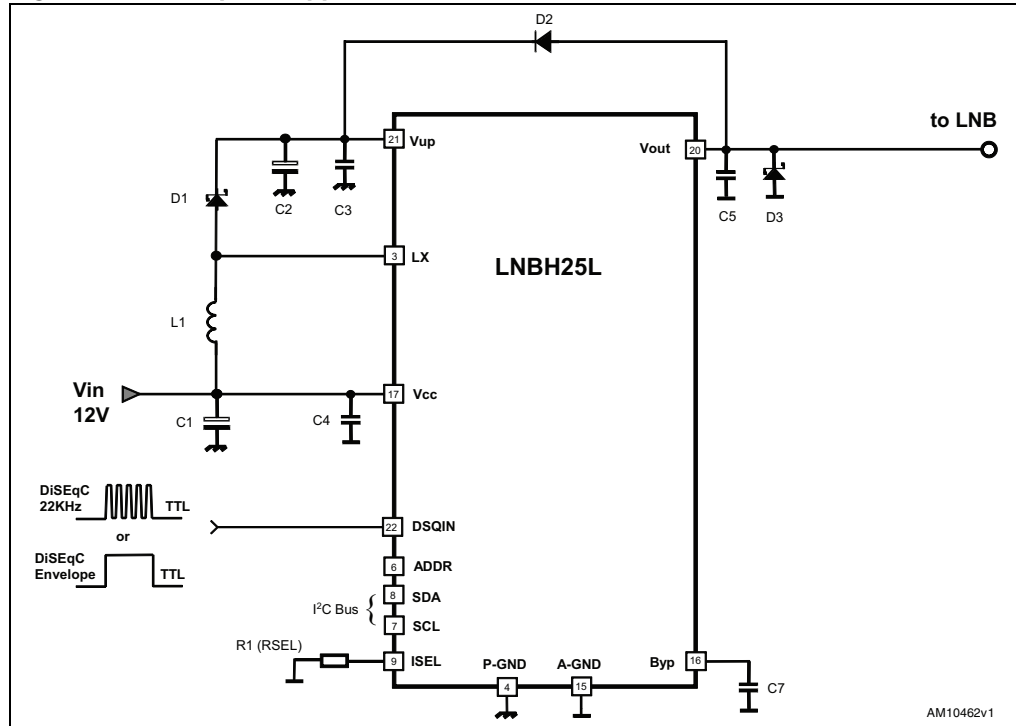

Table 5. Typical application circuit bill of material

| Component | Notes |
|-----------|---|
| R1 (RSEL) | SMD resistor. Refer to Table 12 and ISEL pin description in Table 2 |
| C1, C2 | > 25 V electrolytic capacitor, 100 μ F is suitable. |
| C3 | From 470 nF to 2.2 μ F ceramic capacitor. Higher values allow lower DC-DC noise. |
| C5 | From 100 nF to 220 nF ceramic capacitor. Higher values allow lower DC-DC noise. |
| C4, C7 | 220 nF ceramic capacitors. |
| D1 | STPS130A or similar schottky diode. |
| D3 | BAT54, BAT43, 1N5818, or any low power schottky diode with $I_F (AV) > 0.2$ A, $V_{RRM} > 25$ V, $V_F < 0.5$ V. To be placed as close as possible to V_{OUT} pin. |
| D2 | 1N4001-07, S1A-S1M, or any similar general purpose rectifier. |
| L1 | 10 μ H inductor with $I_{sat} > I_{peak}$ where I_{peak} is the boost converter peak current. |

6 I²C bus interface

Data transmission from the main microprocessor to the LNBH25L and vice versa takes place through the 2-wire I²C bus interface, consisting of the 2-line SDA and SCL (pull-up resistors to positive supply voltage must be externally connected).

6.1 Data validity

As shown in [Figure 7](#), the data on the SDA line must be stable during the high semi-period of the clock. The HIGH and LOW state of the data line can only change when the clock signal on the SCL line is LOW.

6.2 Start and stop condition

As shown in [Figure 8](#), a start condition is a HIGH to LOW transition of the SDA line while SCL is HIGH. The stop condition is a LOW to HIGH transition of the SDA line while SCL is HIGH. A STOP condition must be sent before each START condition.

6.3 Byte format

Every byte transferred to the SDA line must contain 8 bits. Each byte must be followed by an acknowledge bit. The MSB is transferred first.

6.4 Acknowledge

The master (microprocessor) puts a resistive HIGH level on the SDA line during the acknowledge clock pulse (see [Figure 9](#)). The peripheral (LNBH25L) that acknowledges must pull down (LOW) the SDA line during the acknowledge clock pulse, so that the SDA line is stable LOW during this clock pulse. The peripheral which has been addressed must generate an acknowledge after the reception of each byte, otherwise the SDA line remains at the HIGH level during the ninth clock pulse time. In this case the master transmitter can generate the STOP information in order to abort the transfer. The LNBH25L does not generate an acknowledge if the V_{CC} supply is below the undervoltage lockout threshold (4.7 V typ.).

6.5 Transmission without acknowledge

To avoid detection of the LNBH25L acknowledges, the microprocessor can use a simpler transmission: it simply waits one clock cycle without checking the slave acknowledging, and sends the new data. This approach is of course less protected from misworking and decreases the noise immunity.

Figure 7. Data validity on the I²C bus

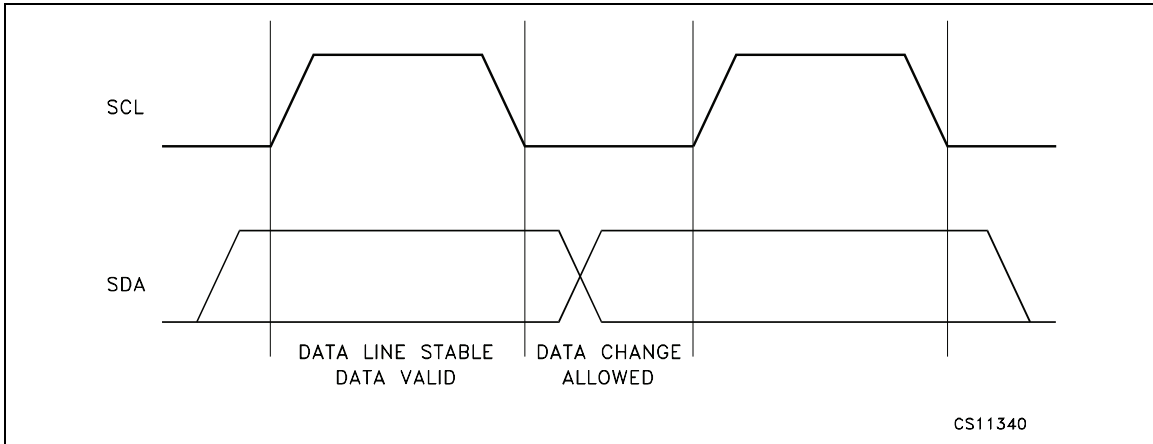

Figure 8. Timing diagram of I²C bus

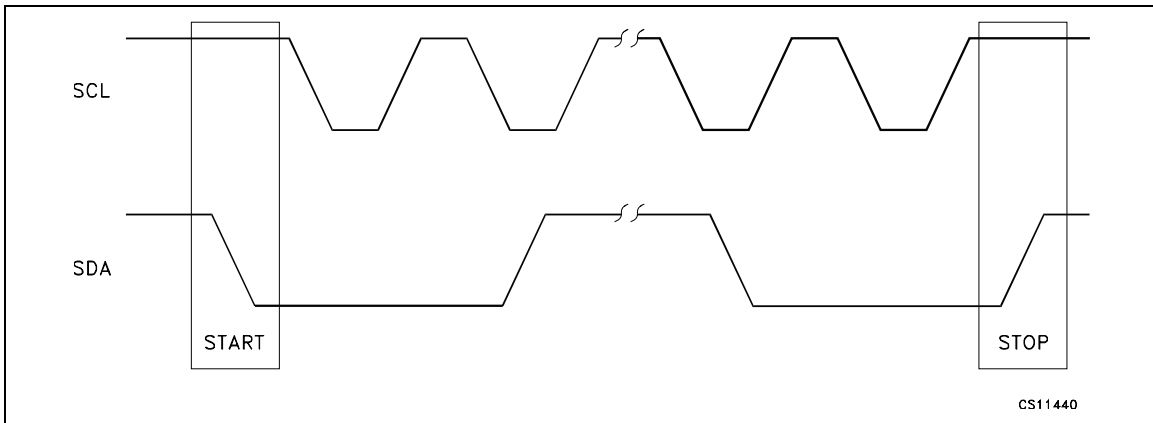
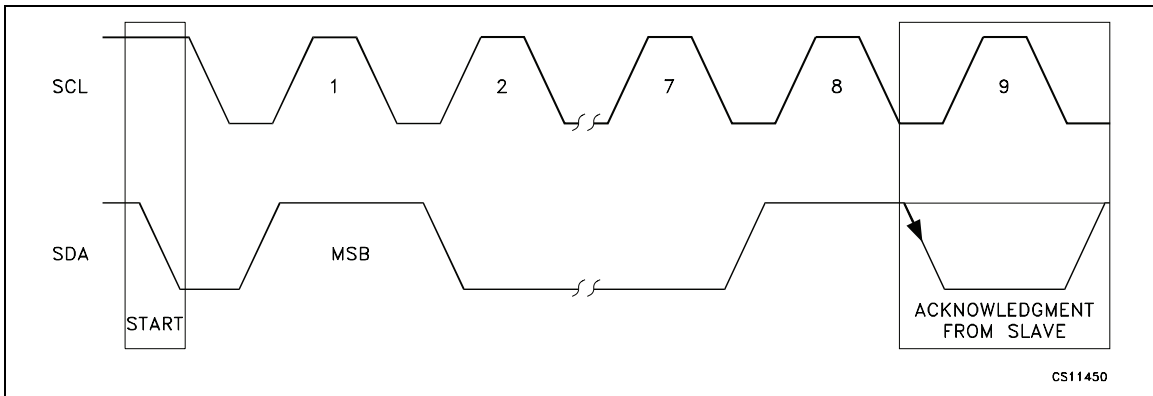

Figure 9. Acknowledge on the I²C bus



7 I²C interface protocol

7.1 Write mode transmission

The LNBH25L interface protocol is made up of:

- a start condition (S)
- a chip address byte with the LSB bit R/W = 0
- a register address (internal address of the first register to be accessed)
- a sequence of data (byte to write in the addressed internal register + acknowledge)
- the following bytes, if any, to be written in successive internal registers
- a stop condition (P). The transfer lasts until a stop bit is encountered
- the LNBH25L, as slave, acknowledges every byte transfer.

Figure 10. Example of writing procedure starting with first data address 0x2 (a)

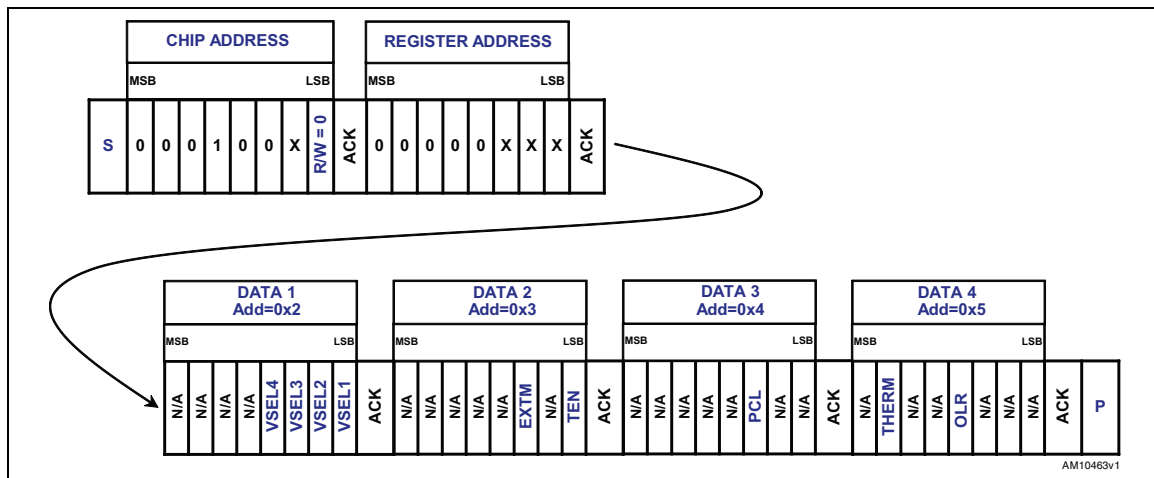

ACK = Acknowledge

S = Start

P = Stop

R/W = 1/0, Read/Write bit

X = 0/1, set the values to select the CHIP ADDRESS (see [Table 15](#) for pin selection) and to select the REGISTER ADDRESS (see [Table 6](#) to [Table 11](#)).

- a. The writing procedure can start from any register address by simply setting the X values in the register address byte (after the chip address). It can be also stopped from the master by sending a stop condition after any acknowledge bit.

7.2 Read mode transmission

In read mode the bytes sequence must be as follows:

- a start condition (S)
- a chip address byte with the LSB bit R/W=0
- the register address byte of the internal first register to be accessed
- a stop condition (P)
- a new master transmission with the chip address byte and the LSB bit R/W=1
- after the acknowledge the LNBH25L starts to send the addressed register content. As long as the master keeps the acknowledge LOW, the LNBH25L transmits the next address register byte content.
- the transmission is terminated when the master sets the acknowledge HIGH with a following stop bit.

Figure 11. Example of reading procedure starting with first status address 0X0 (b)

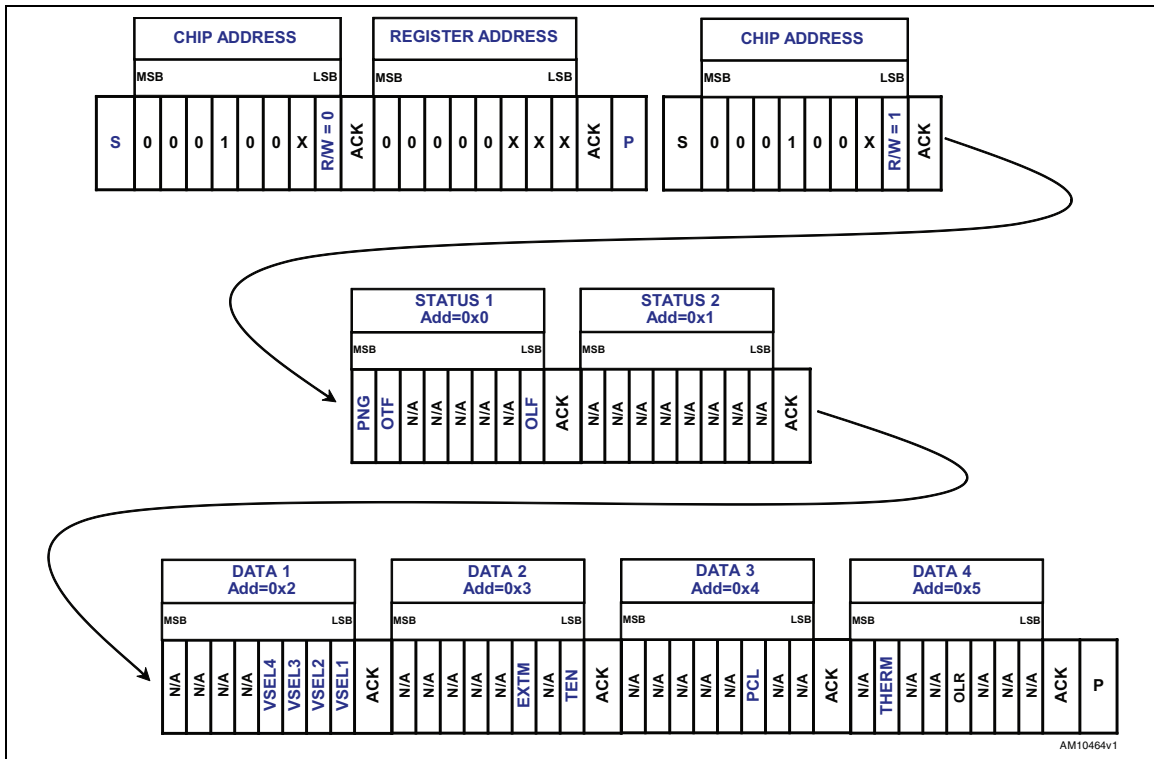

ACK = Acknowledge

S = Start

P = Stop

R/W = 1/0, Read/Write bit

X = 0/1, set the values to select the CHIP ADDRESS (see [Table 15](#) for pin selection) and to select the REGISTER ADDRESS (see [Table 6](#) to [Table 11](#)).

- b. The reading procedure can start from any register address (Status 1, 2 or Data1..4) by simply setting the X values in the register address byte (after the first chip address in the above figure). It can be also stopped from the master by sending a stop condition after any acknowledge bit.

7.3 Data registers

The data 1..4 registers can be addressed both in write and read mode. In read mode they return the last writing byte status received in the previous write transmission.

The following tables provide the register address values of data 1..4 and a function description of each bit.

Table 6. Data 1 (read/write register. Register address = 0X2)

| BIT | Name | Value | Description |
|-------------|-------|-------|---|
| Bit 0 (LSB) | VSEL1 | 0/1 | Output voltage selection bits. (Refer to Table 13) |
| Bit 1 | VSEL2 | 0/1 | |
| Bit 2 | VSEL3 | 0/1 | |
| Bit 3 | VSEL4 | 0/1 | |
| Bit 4 | N/A | 0 | Reserved. Keep to "0" |
| Bit 5 | N/A | 0 | Reserved. Keep to "0" |
| Bit 6 | N/A | 0 | Reserved. Keep to "0" |
| Bit 7 (MSB) | N/A | 0 | Reserved. Keep to "0" |

N/A = Reserved bit.

All bits reset to "0" at power-on.

Table 7. Data 2 (read/write register. Register address = 0X3)

| BIT | Name | Value | Description |
|-------------|------|-------|---|
| Bit 0 (LSB) | TEN | 1 | 22 kHz tone enabled. Tone output controlled by the DSQIN pin |
| | | 0 | 22 kHz tone output disabled |
| Bit 1 | N/A | 0 | Reserved. Keep to "0" |
| Bit 2 | EXTM | 1 | DSQIN input pin is set to receive external 22 kHz TTL signal source |
| | | 0 | DSQIN input pin is set to receive external DiSEqC envelope TTL signal |
| Bit 3 | N/A | 0 | Reserved. Keep to "0" |
| Bit 4 | N/A | 0 | Reserved. Keep to "0" |
| Bit 5 | N/A | 0 | Reserved. Keep to "0" |
| Bit 6 | N/A | 0 | Reserved. Keep to "0" |
| Bit 7 (MSB) | N/A | 0 | Reserved. Keep to "0" |

N/A = Reserved bit.

All bits reset to "0" at power-on.

Table 8. Data 3 (read/write register. Register address = 0X4)

| BIT | Name | Value | Description |
|-------------|------|-------|---|
| Bit 0 (LSB) | N/A | 0 | Reserved. Keep to "0" |
| Bit 1 | N/A | 0 | Reserved. Keep to "0" |
| Bit 2 | PCL | 1 | Pulsed (Dynamic) LNB output current limiting is deactivated |
| | | 0 | Pulsed (Dynamic) LNB output current limiting is activated |
| Bit 3 | N/A | 0 | Reserved. Keep to "0" |
| Bit 4 | N/A | 0 | Reserved. Keep to "0" |
| Bit 5 | N/A | 0 | Reserved. Keep to "0" |
| Bit 6 | N/A | 0 | Reserved. Keep to "0" |
| Bit 7 (MSB) | N/A | 0 | Reserved. Keep to "0" |

N/A = Reserved bit.

All bits reset to "0" at power-on.

Table 9. Data 4 (read/write register. Register address = 0X5)

| BIT | Name | Value | Description |
|-------------|-------|-------|---|
| Bit 0 (LSB) | N/A | 0 | Reserved. Keep to "0" |
| Bit 1 | N/A | 0 | Reserved. Keep to "0" |
| Bit 2 | N/A | 0 | Reserved. Keep to "0" |
| Bit 3 | OLR | 1 | In case of overload protection activation (OLF=1), all VSEL 1..4 bits are reset to "0" and LNB output (V _{OUT} pin) is disabled. The VSEL bits must be set again by the master after the overcurrent condition is removed (OLF=0). |
| | | 0 | In case of overload protection activation (OLF=1) the LNB output (V _{OUT} pin) is automatically enabled as soon as the overload condition is removed (OLF=0) with the previous VSEL bits setting. |
| Bit 4 | N/A | 0 | Reserved. Keep to "0" |
| Bit 5 | N/A | 0 | Reserved. Keep to "0" |
| Bit 6 | THERM | 1 | If thermal protection is activated (OTF=1), all VSEL 1..4 bits are reset to "0" and LNB output (V _{OUT} pin) is disabled. The VSEL bits must be set again by the master after the overtemperature condition is removed (OTF=0). |
| | | 0 | In case of thermal protection activation (OTF=1) the LNB output (V _{OUT} pin) is automatically enabled as soon as the overtemperature condition is removed (OTF=0) with the previous VSEL bits setting. |
| Bit 7 (MSB) | N/A | 0 | Reserved. Keep to "0" |

N/A = Reserved bit.

All bits reset to "0" at power-on.

7.4 Status registers

The STATUS 1, 2 registers can be addressed only in read mode and provide the diagnostic functions described in the following tables.

Table 10. STATUS 1 (Read register. Register address = 0X0)

| BIT | Name | Value | Description |
|-------------|------|-------|--|
| Bit 0 (LSB) | OLF | 1 | V _{OUT} pin overload protection has been triggered ($I_{OUT} > I_{MAX}$). Refer to Table 8 for the overload operation settings (PCL bit). |
| | | 0 | No overload protection has been triggered to the V _{OUT} pin ($I_{OUT} < I_{MAX}$). |
| Bit 1 | N/A | - | Reserved |
| Bit 2 | N/A | - | Reserved |
| Bit 3 | N/A | - | Reserved |
| Bit 4 | N/A | - | Reserved |
| Bit 5 | N/A | - | Reserved |
| Bit 6 | OTF | 1 | Junction overtemperature is detected, $T_J > 150$ °C. See also the THERM bit setting in Table 9 . |
| | | 0 | Junction overtemperature not detected, $T_J < 135$ °C. T_J is below thermal protection threshold. |
| Bit 7 (MSB) | PNG | 1 | Input voltage (V _{CC} pin) lower than LPD minimum thresholds. Refer to Table 12 . |
| | | 0 | Input voltage (V _{CC} pin) higher than LPD thresholds. Refer to Table 12 . |

N/A = Reserved bit.

All bits reset to “0” at power-on.

Table 11. STATUS 2 (Read register. Register address = 0X1)

| BIT | Name | Value | Description |
|-------------|------|-------|-------------|
| Bit 0 (LSB) | N/A | - | Reserved |
| Bit 1 | N/A | - | Reserved |
| Bit 2 | N/A | - | Reserved |
| Bit 3 | N/A | - | Reserved |
| Bit 4 | N/A | - | Reserved |
| Bit 5 | N/A | - | Reserved |
| Bit 6 | N/A | - | Reserved |
| Bit 7 (MSB) | N/A | - | Reserved |

N/A = Reserved bit.

All bits reset to “0” at power-on.

8 Electrical characteristics

Refer to [Section 5](#), T_J from 0 to 85 °C, all data 1..4 register bits set to 0 unless $VSEL1 = 1$, $RSEL = 16.2\text{ k}\Omega$, $DSQIN = \text{LOW}$, $V_{IN} = 12\text{ V}$, $I_{OUT} = 50\text{ mA}$, unless otherwise stated. Typical values are referred to $T_J = 25\text{ }^\circ\text{C}$. $V_{OUT} = V_{OUT}$ pin voltage. See software description section for I²C access to the system register ([Section 6](#) and [Section 7](#)).

Table 12. Electrical characteristics

| Symbol | Parameter | Test conditions | Min. | Typ. | Max. | Unit |
|----------------------|---------------------------------------|---|------|--------------|------|---------------|
| V_{IN} | Supply voltage ⁽¹⁾ | | 8 | 12 | 16 | V |
| I_{IN} | Supply current | $I_{OUT} = 0\text{ mA}$ | | 6 | | mA |
| | | 22 kHz tone enabled (TEN=1, DSQIN=High), $I_{OUT} = 0\text{ mA}$ | | 10 | | |
| | | $VSEL1 = VSEL2 = VSEL3 = VSEL4 = 0$ | | 1 | | |
| V_{OUT} | Output voltage total accuracy | Valid at any V_{OUT} selected level | -3.5 | | +3.5 | % |
| V_{OUT} | Line regulation | $V_{IN} = 8\text{ to }16\text{ V}$ | | | 40 | mV |
| V_{OUT} | Load regulation | I_{OUT} from 50 to 500 mA | | 75 | 100 | |
| I_{MAX} | Output current limiting thresholds | $RSEL = 16.2\text{ k}\Omega$ | 500 | | 750 | mA |
| | | $RSEL = 22\text{ k}\Omega$ | 350 | | 550 | |
| I_{SC} | Output short-circuit current | $RSEL = 16.2\text{ k}\Omega$ | | 350 | | mA |
| SS | Soft-start time | V_{OUT} from 0 to 13 V | | 4 | | ms |
| SS | Soft-start time | V_{OUT} from 0 to 18 V | | 6 | | ms |
| T13-18 | Soft transition rise time | V_{OUT} from 13V to 18 V | | 1.5 | | ms |
| T18-13 | Soft transition fall time | V_{OUT} from 18V to 13 V | | 1.5 | | ms |
| T_{OFF} | Dynamic overload protection OFF time | PCL=0, output shorted | | 900 | | ms |
| T_{ON} | Dynamic overload protection ON time | PCL=0, output shorted | | $T_{OFF}/10$ | | |
| A_{TONE} | Tone amplitude | DSQIN=High, EXTM=0, TEN=1 I_{OUT} from 0 to 500 mA C_{BUS} from 0 to 750 nF | 0.55 | 0.675 | 0.8 | V_{PP} |
| F_{TONE} | Tone frequency | | 20 | 22 | 24 | kHz |
| D_{TONE} | Tone duty cycle | DSQIN=High, EXTM=0, TEN=1 | 43 | 50 | 57 | % |
| t_r, t_f | Tone rise or fall time ⁽²⁾ | | 5 | 8 | 15 | μs |
| Eff _{DC/DC} | DC-DC converter efficiency | $I_{OUT} = 500\text{ mA}$ | | 93 | | % |
| F_{SW} | DC-DC converter switching frequency | | | 440 | | kHz |
| UVLO | Undervoltage lockout thresholds | UVLO threshold rising | | 4.8 | | V |
| | | UVLO threshold falling | | 4.7 | | |
| V_{LP} | Low power diagnostic (LPD) thresholds | V_{LP} threshold rising | | 7.2 | | V |
| | | V_{LP} threshold falling | | 6.7 | | |

Table 12. Electrical characteristics (continued)

| Symbol | Parameter | Test conditions | Min. | Typ. | Max. | Unit |
|----------------------|-------------------------------|---|------|------|------|--------------------|
| V_{IL} | DSQIN, pin logic low | | | | 0.8 | V |
| V_{IH} | DSQIN, pin logic high | | 2 | | | V |
| I_{IH} | DSQIN, pin input current | $V_{IH}=5\text{ V}$ | | 15 | | μA |
| I_{OBK} | Output backward current | All VSELx=0, $V_{OBK}=30\text{ V}$ | | -3 | -6 | mA |
| I_{SINK} | Output low-side sink current | V_{OUT} forced at $V_{OUT_nom}+0.1\text{ V}$ | | 70 | | mA |
| $I_{SINK_TIME-OUT}$ | Low-side sink current timeout | V_{OUT} forced at $V_{OUT_nom}+0.1\text{ V}$ | | 10 | | ms |
| I_{REV} | Max. reverse current | V_{OUT} forced at $V_{OUT_nom}+0.1\text{ V}$, after $I_{SINK_TIME-OUT}$ is elapsed | | 2 | | mA |
| T_{SHDN} | Thermal shutdown threshold | | | 150 | | $^{\circ}\text{C}$ |
| ΔT_{SHDN} | Thermal shutdown hysteresis | | | 15 | | $^{\circ}\text{C}$ |

1. In applications where $(V_{CC}-V_{OUT}) > 1.3\text{ V}$, the increased power dissipation inside the integrated LDO must be taken into account in the application thermal management design.

2. Guaranteed by design.

Table 13. Output voltage selection table (Data1 register, write mode)

| VSEL4 | VSEL3 | VSEL2 | VSEL1 | V_{OUT} min. | V_{OUT} pin voltage | V_{OUT} max. | Function |
|-------|-------|-------|-------|----------------|-----------------------|----------------|--|
| 0 | 0 | 0 | 0 | | 0.000 | | V_{OUT} disabled. LNBH25L set in standby |
| 0 | 0 | 0 | 1 | 12.545 | 13.000 | 13.455 | |
| 0 | 0 | 1 | 0 | 12.867 | 13.333 | 13.800 | |
| 0 | 0 | 1 | 1 | 13.188 | 13.667 | 14.145 | |
| 0 | 1 | 0 | 0 | 13.51 | 14.000 | 14.490 | |
| | | | | | | | |
| 1 | 0 | 0 | 0 | 17.515 | 18.150 | 18.785 | |
| 1 | 0 | 0 | 1 | 17.836 | 18.483 | 19.130 | |
| 1 | 0 | 1 | 0 | 18.158 | 18.817 | 19.475 | |
| 1 | 0 | 1 | 1 | 18.48 | 19.150 | 19.820 | |

T_J from 0 to 85 °C, $V_I = 12$ V.

Table 14. I²C electrical characteristics

| Symbol | Parameter | Test conditions | Min. | Typ. | Max. | Unit |
|-----------|---|-----------------------------------|------|------|------|---------|
| V_{IL} | Low level input voltage | SDA, SCL | | | 0.8 | V |
| V_{IH} | High level input voltage | SDA, SCL | 2 | | | V |
| I_{IN} | Input current | SDA, SCL, $V_{IN} = 0.4$ to 4.5 V | -10 | | 10 | μ A |
| V_{OL} | Low level output voltage ⁽¹⁾ | SDA (open drain), $I_{OL} = 6$ mA | | | 0.6 | V |
| F_{MAX} | Maximum clock frequency | SCL | 400 | | | kHz |

1. Guaranteed by design.

T_J from 0 to 85 °C, $V_I = 12$ V.

Table 15. Address pin characteristics

| Symbol | Parameter | Test condition | Min. | Typ. | Max. | Unit |
|--------------|--|--|------|------|------|------|
| V_{ADDR-1} | "0001000(R/W)" address pin voltage range | R/W bit determines the transmission mode: read (R/W=1) write (R/W=0) | 0 | | 0.8 | V |
| V_{ADDR-2} | "0001001(R/W)" address pin voltage range | R/W bit determines the transmission mode: read (R/W=1) write (R/W=0) | 2 | | 5 | V |

9 Package mechanical data

In order to meet environmental requirements, ST offers these devices in different grades of ECOPACK® packages, depending on their level of environmental compliance. ECOPACK specifications, grade definitions and product status are available at: www.st.com. ECOPACK is an ST trademark.

Table 16. QFN24L (4 x 4 mm) mechanical data

| Dim. | (mm) | | |
|------|------|------|------|
| | Min. | Typ. | Max. |
| A | 0.80 | 0.90 | 1.00 |
| A1 | 0.00 | 0.02 | 0.05 |
| b | 0.18 | 0.25 | 0.30 |
| D | 3.90 | 4.00 | 4.10 |
| D2 | 2.55 | 2.70 | 2.80 |
| E | 3.90 | 4.00 | 4.10 |
| E2 | 2.55 | 2.70 | 2.80 |
| e | 0.45 | 0.50 | 0.55 |
| L | 0.25 | 0.35 | 0.45 |

Figure 12. QFN24L (4 x 4 mm) package dimensions

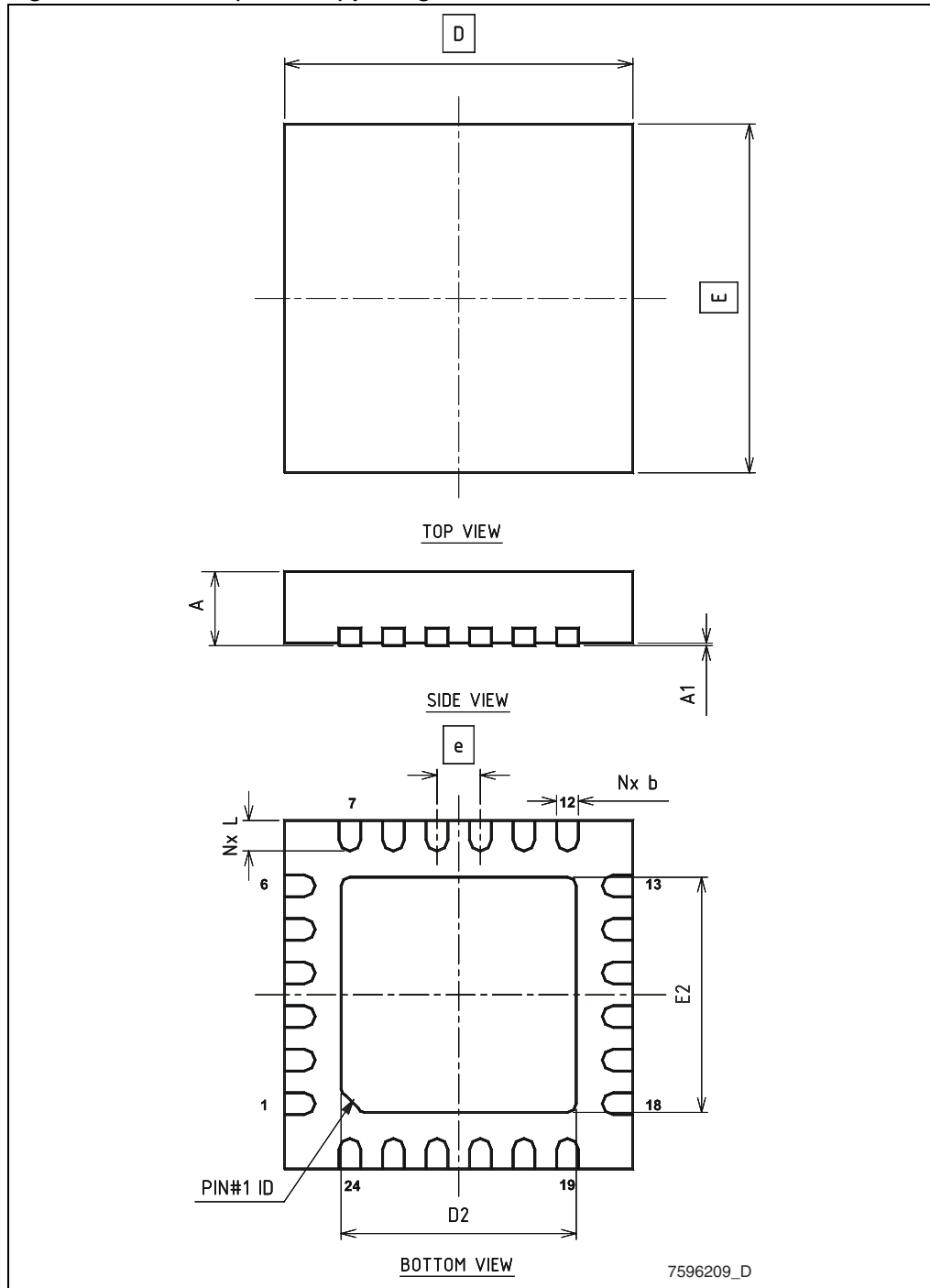

Tape & reel QFNxx/DFNxx (4x4) mechanical data

| Dim. | mm. | | | inch. | | |
|------|------|------|------|-------|-------|--------|
| | Min. | Typ. | Max. | Min. | Typ. | Max. |
| A | | | 330 | | | 12.992 |
| C | 12.8 | | 13.2 | 0.504 | | 0.519 |
| D | 20.2 | | | 0.795 | | |
| N | 99 | | 101 | 3.898 | | 3.976 |
| T | | | 14.4 | | | 0.567 |
| Ao | | 4.35 | | | 0.171 | |
| Bo | | 4.35 | | | 0.171 | |
| Ko | | 1.1 | | | 0.043 | |
| Po | | 4 | | | 0.157 | |
| P | | 8 | | | 0.315 | |

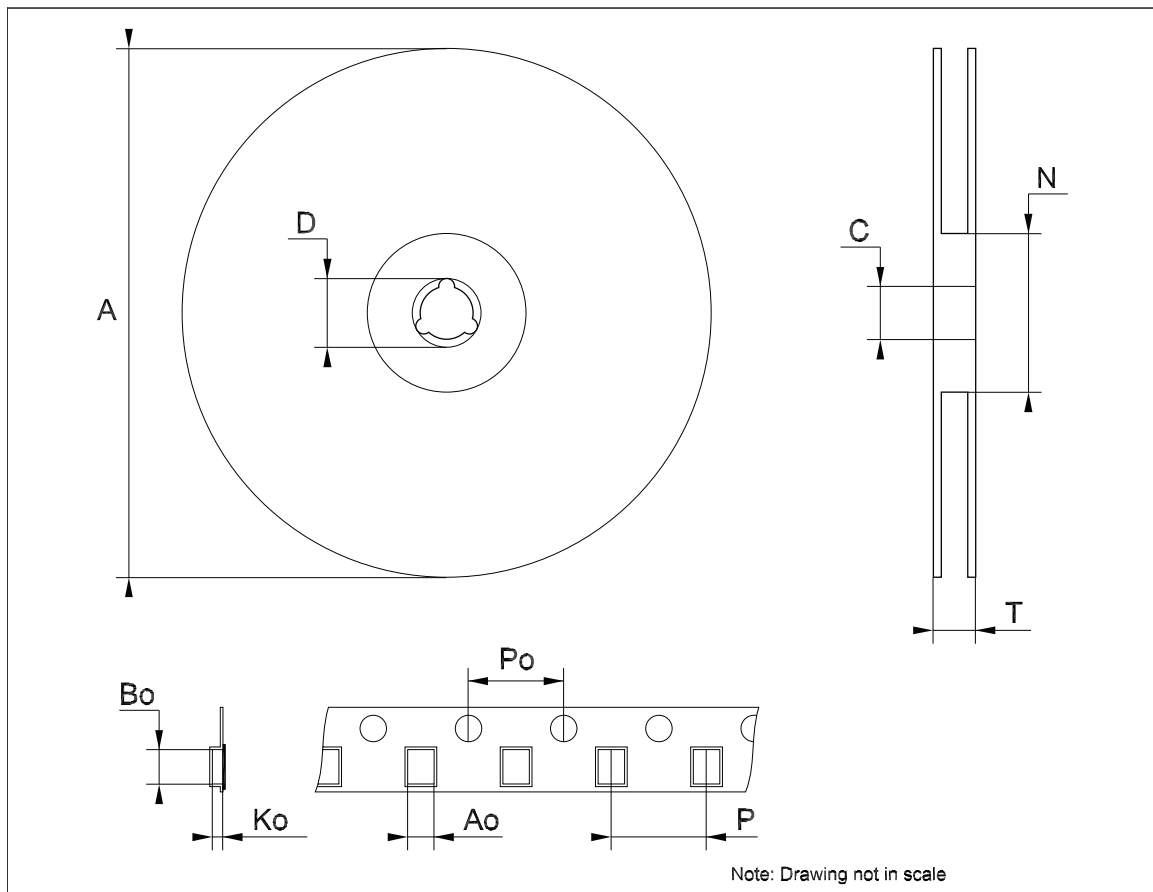
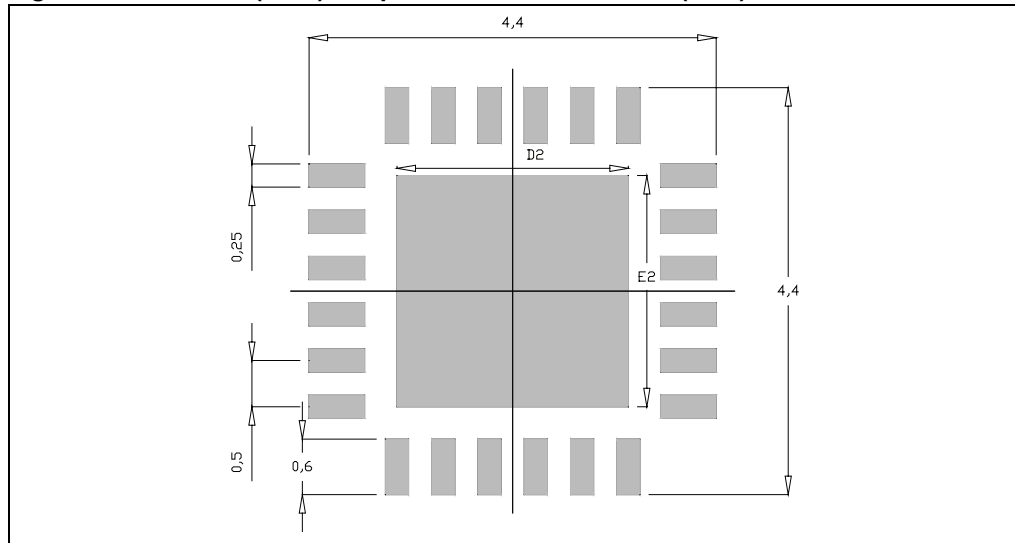

Figure 13. QFN24L (4 x 4) footprint recommended data (mm.)



10 Revision history

Table 17. Document revision history

| Date | Revision | Changes |
|-------------|----------|--|
| 09-Jan-2012 | 1 | Initial release. |
| 15-Feb-2012 | 2 | Modified: D1 and D3 Table 5 on page 12 . |

Please Read Carefully:

Information in this document is provided solely in connection with ST products. STMicroelectronics NV and its subsidiaries ("ST") reserve the right to make changes, corrections, modifications or improvements, to this document, and the products and services described herein at any time, without notice.

All ST products are sold pursuant to ST's terms and conditions of sale.

Purchasers are solely responsible for the choice, selection and use of the ST products and services described herein, and ST assumes no liability whatsoever relating to the choice, selection or use of the ST products and services described herein.

No license, express or implied, by estoppel or otherwise, to any intellectual property rights is granted under this document. If any part of this document refers to any third party products or services it shall not be deemed a license grant by ST for the use of such third party products or services, or any intellectual property contained therein or considered as a warranty covering the use in any manner whatsoever of such third party products or services or any intellectual property contained therein.

UNLESS OTHERWISE SET FORTH IN ST'S TERMS AND CONDITIONS OF SALE ST DISCLAIMS ANY EXPRESS OR IMPLIED WARRANTY WITH RESPECT TO THE USE AND/OR SALE OF ST PRODUCTS INCLUDING WITHOUT LIMITATION IMPLIED WARRANTIES OF MERCHANTABILITY, FITNESS FOR A PARTICULAR PURPOSE (AND THEIR EQUIVALENTS UNDER THE LAWS OF ANY JURISDICTION), OR INFRINGEMENT OF ANY PATENT, COPYRIGHT OR OTHER INTELLECTUAL PROPERTY RIGHT.

UNLESS EXPRESSLY APPROVED IN WRITING BY TWO AUTHORIZED ST REPRESENTATIVES, ST PRODUCTS ARE NOT RECOMMENDED, AUTHORIZED OR WARRANTED FOR USE IN MILITARY, AIR CRAFT, SPACE, LIFE SAVING, OR LIFE SUSTAINING APPLICATIONS, NOR IN PRODUCTS OR SYSTEMS WHERE FAILURE OR MALFUNCTION MAY RESULT IN PERSONAL INJURY, DEATH, OR SEVERE PROPERTY OR ENVIRONMENTAL DAMAGE. ST PRODUCTS WHICH ARE NOT SPECIFIED AS "AUTOMOTIVE GRADE" MAY ONLY BE USED IN AUTOMOTIVE APPLICATIONS AT USER'S OWN RISK.

Resale of ST products with provisions different from the statements and/or technical features set forth in this document shall immediately void any warranty granted by ST for the ST product or service described herein and shall not create or extend in any manner whatsoever, any liability of ST.

ST and the ST logo are trademarks or registered trademarks of ST in various countries.

Information in this document supersedes and replaces all information previously supplied.

The ST logo is a registered trademark of STMicroelectronics. All other names are the property of their respective owners.

© 2012 STMicroelectronics - All rights reserved

STMicroelectronics group of companies

Australia - Belgium - Brazil - Canada - China - Czech Republic - Finland - France - Germany - Hong Kong - India - Israel - Italy - Japan - Malaysia - Malta - Morocco - Philippines - Singapore - Spain - Sweden - Switzerland - United Kingdom - United States of America

www.st.com