

Plug Adapter Assemblies 600 Series

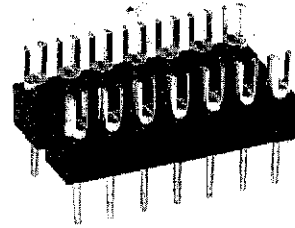

614-CG1

FEATURES:

The 600 Series is a high quality machined pin molded adaptor which is used to assemble hybrid and special network circuits. The .018" (0,46) diameter precision pin allows the adaptor to be plugged into socket or wire wrappable panels repeatedly.

- Precision machined pins
- Used for interposing discrete components
- Terminals are the same dimension as IC board patterns
- Option of round, solder pocket or slotted pin styles
- Thermoplastic polyester insulators
- Large variety of styles:
 - 8, 14, 16, 20 pins - .300" (7,62) between rows
 - 22 pins - .400" (10,16) between rows
 - 14, 16, 24, 28, 32, 36, and 40 pins - .600" (15,24) between rows
 - 14 & 16 pins - .800" (20,32) between rows

MATERIAL SPECIFICATIONS:

Insulator Thermoplastic polyester, UL rated 94V-0
 Pins Phosphor bronze, gold or tin/lead plated

PERFORMANCE SPECIFICATIONS:

MECHANICAL

Vibration Tested to a frequency range of 10 to 2,000 Hz and returned to 10Hz in three perpendicular planes at a double amplitude of .06" (1,52) or 20 G's, whichever was less per MIL-STD-202, Method 204

Mechanical Shock Will meet the requirements of MIL-STD-202, Method 213 when subjected to a shock test at 150 G's acceleration

ELECTRICAL

Current Rating 5 Amps when tested with a 30-gauge wire attached. Terminal will have a maximum 30°C temperature rise above ambient

Capacitance At a test frequency of 1 KHz, adjacent and/or terminal all at guard potential

Adjacent terminal:

AG and CG solder tail36pF

BG (solder pocket)42pF

Opposite Terminal:

AG and CG solder tail025pF

BG (solder pocket)034pF

Dielectric Withstanding

Voltage 1,000 VRMS @ 30 inches mercury, .500 VRMS when tested @ 0.9 inches mercury, tested per MIL-STD-202, Method 301

Insulation Resistance ... 1×10^{12} Ohms, tested to MIL-STD 202, Method 302, tested @ 500 Volts

ENVIRONMENTAL

Thermal Shock No visual damage when tested in accordance with MIL-STD-202, Method 107, test condition F for 5 consecutive cycles of -65°C to +150°C

Operating

Temperatures -65°C to +125°C

Salt Spray No visual evidence of corrosion on Gold terminals when tested per MIL-STD-202, Method 101 Test condition B for 48 hours and a 5% salt solution

F

Need more technical information?

Consult your TE Connectivity sales office listed on the back cover

F3

TE Connectivity
 1555 Lynnfield Road
 Memphis, TN 38119
 (901) 682-8221 FAX (901) 537-8805

2003

600 Series Plug Adapter Assemblies

STANDARD CONFIGURATIONS

Number of Pins	Pin Style	Gold Part Number	Tin Part Number	"A" Max.	"B" Typ.	"C" *	"D ₁ " **	"D ₂ " **	"D ₃ " **	Figure
8	Round	608-AG1	608-AG1T	.400 (10,16)	.300 (7,62)	.300 (7,62)	—	—	—	1A
	Solder Pocket	608-BG1	608-BG1T							1B
	Slotted	608-CG1	608-CG1T							1C
14	Round	614-AG1	614-AG1T	.700 (17,78)	.600 (15,24)	.300 (7,62)	—	—	—	1A
	Solder Pocket	614-BG1	614-BG1T							1B
	Slotted	614-CG1	614-CG1T							1C
14	Round	614-AG3	614-AG3T	.700 (17,78)	.500 (12,70)	.600 (15,24)	.400 (10,16)	—	—	2A
	Solder Pocket	614-BG3	614-BG3T							2B
	Slotted	614-CG3	614-CG3T							2C
14	Round	614-AG2	614-AG2T	.750 (19,05)	.600 (15,24)	.800 (20,32)	—	—	—	3A
	Solder Pocket	614-BG2	614-BG2T							3B
	Slotted	614-CG2	614-CG2T							3C
16	Round	616-AG1	616-AG1T	.800 (20,32)	.700 (17,78)	.300 (7,62)	—	—	—	1A
	Solder Pocket	616-BG1	616-BG1T							1B
	Slotted	616-CG1	616-CG1T							1C
16	Round	616-AG3	616-AG3T	.800 (20,32)	.700 (17,78)	.600 (15,24)	.400 (10,16)	—	—	2A
	Solder Pocket	616-BG3	616-BG3T							2B
	Slotted	616-CG3	616-CG3T							2C
16	Round	616-AG2	616-AG2T	.850 (21,59)	.700 (17,78)	.800 (20,32)	—	—	—	3A
	Solder Pocket	616-BG2	616-BG2T							3B
	Slotted	616-CG2	616-CG2T							3C
18	Round	618-AG1	618-AG1T	.900 (22,86)	.800 (20,32)	.300 (7,62)	—	—	—	1A
	Solder Pocket	618-BG1	618-BG1T							1B
	Slotted	618-CG1	618-CG1T							1C
20	Round	620-AG1	620-AG1T	1.000 (25,90)	.900 (22,86)	.300 (7,62)	—	—	—	1A
	Solder Pocket	620-BG1	620-BG1T							1B
	Slotted	620-CG1	620-CG1T							1C
22	Round	622-AG1	622-AG1T	1.150 (29,21)	1.000 (25,90)	.400 (10,16)	—	—	—	1A
	Solder Pocket	622-BG1	622-BG1T							1B
	Slotted	622-CG1	622-CG1T							1C
24	Round	624-AG1	624-AG1T	1.200 (30,98)	1.100 (27,94)	.600 (15,24)	.900 (22,86)	.400 (10,16)	—	2A
	Solder Pocket	624-BG1	624-BG1T							2B
	Slotted	624-CG1	624-CG1T							2C
28	Round	628-AG2	628-AG2T	1.400 (35,56)	1.300 (33,02)	.600 (15,24)	.900 (22,86)	.400 (10,16)	—	2A
	Solder Pocket	628-BG2	628-BG2T							2B
	Slotted	628-CG2	628-CG2T							2C
32	Round	632-AG2	632-AG2T	1.600 (40,64)	1.500 (38,10)	.600 (15,24)	.900 (22,86)	.400 (10,16)	—	2A
	Solder Pocket	632-BG2	632-BG2T							2B
	Slotted	632-CG2	632-CG2T							2C
36	Round	636-AG1	636-AG1T	1.800 (45,72)	1.700 (43,18)	.600 (15,24)	1.500 (38,10)	.900 (22,86)	.400 (10,16)	2A
	Solder Pocket	636-BG1	636-BG1T							2B
	Slotted	636-CG1	636-CG1T							2C
40	Round	640-AG1	640-AG1T	2.000 (50,80)	1.900 (48,26)	.600 (15,24)	1.500 (38,10)	.900 (22,86)	.400 (10,16)	2A
	Solder Pocket	640-BG1	640-BG1T							2B
	Slotted	640-CG1	640-CG1T							2C

* Dimension C ± .010 (0,25)

** Dimension D₁, D₂, D₃ ± .005 (0,13)

Solderless Wrap Styles:

3 Level Solderless Wrap: add "F" to printed circuit Part Number. Ex. 608-AG1TF



TE Connectivity

F4

TE Connectivity
1555 Lynnfield Road
Memphis, TN 38119
FAX (901) 537-8805
(901) 682-8221

Plug Adapter Assemblies 600 Series

SOLDER STYLE TERMINALS

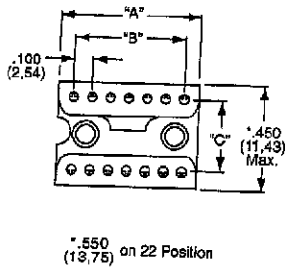

.550 (13,75) on 22 Position

Fig. 1

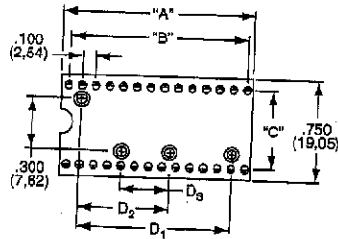

Fig. 2

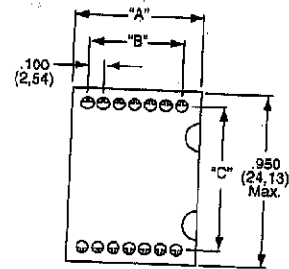

Fig. 3

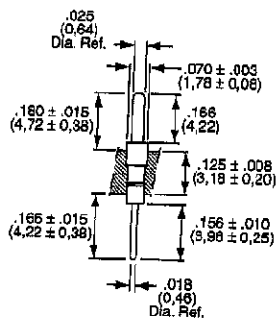

Figure A
8128-41P6 (Gold)

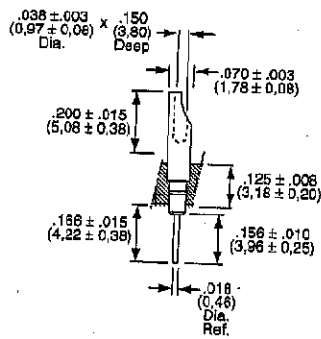

Figure B
8128-40P10 (Gold)

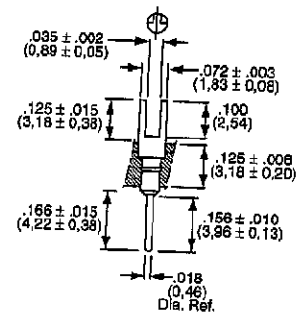

Figure C
8128-39P6 (Gold)

F

Need more technical information?
Consult your TE Connectivity
sales office listed on the back cover

F5

TE Connectivity
1555 Lynnfield Road
Memphis, TN 38119
(901) 682-8221 FAX (901) 537-8805