

THIS DRAWING IS UNPUBLISHED. RELEASED FOR PUBLICATION 2001
 COPYRIGHT 2001 BY TYCO ELECTRONICS CORPORATION. ALL RIGHTS RESERVED.

LOC	DISP	REVISIONS			
P	LTR	DESCRIPTION	DATE	DRN	APVD
0		PRELIMINARY ISSUE	04MAY2001	M.B.	D.C.
A		FIRST ISSUE (ET00-046-02)	07MAR2002	M.B.	D.C.
A1		RELEASED FOR PRODUCTION (ET00-0235-04)	10DEC2004	M.B.	D.C.
A2		UPDATED PARTS TABLE (ECR-06-000726)	16JAN2006		

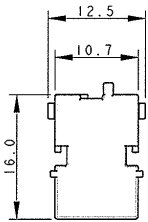
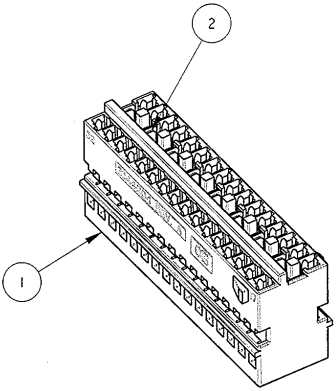

NOTES
(NOTE)

- 1) HOUSING SUITABLE FOR SHELL P/N 284715-1 (BLOCCETTO ADATTO PER LA CORAZZA P/N 284715-1)
- 2) N. 32 CAVITIES SUITABLE FOR FEMALE CONNECTORS MQS P/N 144969-2
 CuNiSi + STAINLESS STEEL SPRING GOLD PLATED ON CONTACT AREA AND IN THE BACK OF THE SPRING
 WIRE SIZE 0.35-0.5 mm2
 (CAVITA' ADATTE PER CONTATTI FEMMINA MQS P.N. 144969-2
 CuNiSi + MOLLA ACCIAIO INOX DORATA NELLA ZONA DI CONTATTO E SUL DORSO DELLA MOLLA
 RANGO FILO 0.35-0.5 mm2)

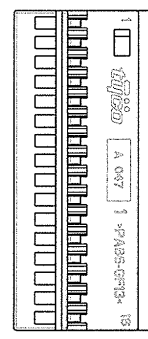
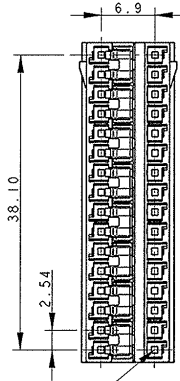
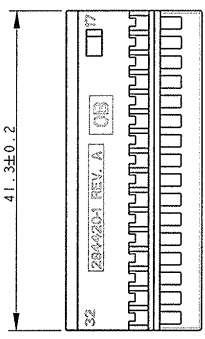

ITEM (VOCE)	DESCRIPTION (DESCRIZIONE)	MATERIAL (MATERIALE)	Q. TY (Q. TA')
1	HOUSING (BLOCCETTO)	PA 66 GF COLOR BLACK (COLORE NERO)	1
2	SHORT CIRCUIT SPRING (MOLLA DI CORTO CIRCUITO)	STAINLESS STEEL (ACCIAIO INOX)	8

284422-1 AS SHOWN
(COME MOSTRATO)

<small>THIS DRAWING IS A CONTROLLED DOCUMENT FOR TYCO ELECTRONICS CORPORATION. IT IS SUBJECT TO CHANGE AND THE CONTROLLING ENGINEERING ORGANIZATION SHOULD BE CONTACTED FOR THE LATEST REVISION.</small>		DWN 04MAY2001 M. BARBERIS CHR 04MAY2001 O. CANUTO APVD - A. GENTA	tyco Electronics Ilyco Electronics AMP Italia S.p.A. C.so F.lli Cervi, 15 Collegno (TO)
DIMENSIONS: mm 	TOLERANCES UNLESS OTHERWISE SPECIFIED: 0 PLC ±0.3 1 PLC ±0.2 2 PLC ±0.1 3 PLC ± 4 PLC ± ANGLES ±°	PRODUCT SPEC APPLICATION SPEC WEIGHT -	32 POSITIONS REC. HOUSING ASS'Y FOR AIRBAG SIZE A3 CAGE CODE 00779 DRAWING NO C-284422 RESTRICTED TO -
MATERIAL SEE TABLE (VEDI TABELLA)	FINISH SEE TABLE (VEDI TABELLA)	CUSTOMER DRAWING	SCALE 2:1 SHEET 1 OF 3 REV A2

THIS DRAWING IS UNPUBLISHED. RELEASED FOR PUBLICATION 2001
 © COPYRIGHT 2001 BY TYCO ELECTRONICS CORPORATION. ALL RIGHTS RESERVED.

LOC		DIST		REVISIONS			
P	LTR	DESCRIPTION	DATE	DRN	APVD		
-		SEE SHEET 1 (VEDI FOGLIO 1)	-	-	-		

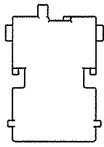
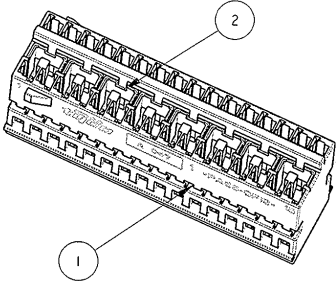

NOTES
 (NOTE)
 1) HOUSING SUITABLE FOR SHELL P/N 284715-2
 (BLOCCETTO ADATTO PER LA CORAZZA P/N 284715-2)
 2) FOR MISSING NOTES AND DIMENSIONS SEE
 P/N 284422-1, SHEET 1 OF 3
 (PER LE NOTE E LE QUOTE MANCANTI VEDERE
 P/N 284422-1, FOGLIO 1 DI 3)

ITEM (VOCE)	DESCRIPTION (DESCRIZIONE)	MATERIAL (MATERIALE)	Q. TY (Q. TA')
1	HOUSING (BLOCCETTO)	PA 66 GF COLOR GRAY (COLORE GRIGIO)	1
2	SHORT CIRCUIT SPRING (MOLLA DI CORTO CIRCUITO)	STAINLESS STEEL (ACCIAIO INOX)	8

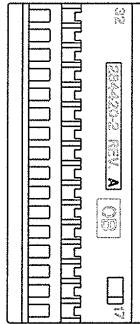
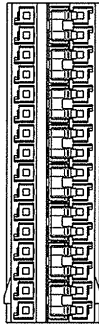
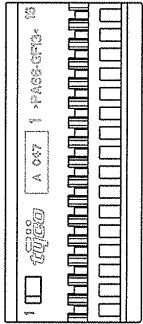

284422-2 AS SHOWN
 (COME MOSTRATO)

<small>THIS DRAWING IS A CONTROLLED DOCUMENT FOR TYCO ELECTRONICS CORPORATION. IT IS SUBJECT TO CHANGE AND THE CONTROLLING ENGINEERING ORGANIZATION SHOULD BE CONTACTED FOR THE LATEST REVISION.</small>		OWN: 04MAY2001 M. BARBERIS CHK: 04MAY2001 Q. CANUTO APVD: A. GENTA	tyco Electronics tyco Electronics AMP Italia S.p.A. C.so F.lli Cervi, 15 Collegno (TO)
DIMENSIONS: mm	TOLERANCES UNLESS OTHERWISE SPECIFIED: 0 PLC ±0.3 1 PLC ±0.2 2 PLC ±0.1 3 PLC ± 4 PLC ± ANGLES ±°	NAME: 32 POSITIONS REC. HOUSING ASS'Y FOR AIRBAG PRODUCT SPEC: APPLICATION SPEC: WEIGHT:	SIZE: A3 CAGE CODE: 00779 DRAWING NO: C-284422 RESTRICTED TO:
MATERIAL: SEE TABLE (VEDI TABELLA) FINISH: SEE TABLE (VEDI TABELLA)	CUSTOMER DRAWING	SCALE: 2:1 SHEET: 2 OF 3 REV: A2	

THIS DRAWING IS UNPUBLISHED. RELEASED FOR PUBLICATION 2001
 © COPYRIGHT 2001 BY TYCO ELECTRONICS CORPORATION. ALL RIGHTS RESERVED.

LOC		DIST		REVISIONS			
P	LTR	DESCRIPTION	DATE	DRN	APVD		
		SEE SHEET 1 (VEDI FOGLIO 1)					

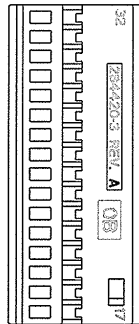
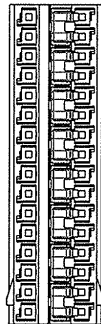
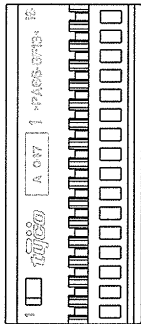
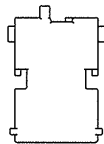
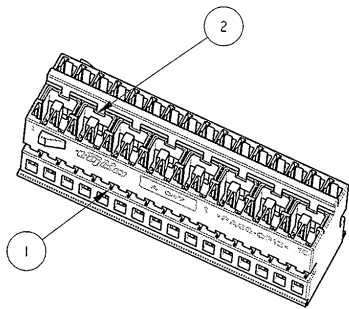

NOTES
(NOTE)

- 1) HOUSING SUITABLE FOR SHELL P/N 284715-3 (BLOCCHETTO ADATTO PER LA CORAZZA P/N 284715-3)
- 2) FOR MISSING NOTES AND DIMENSIONS SEE P/N 284422-1, SHEET 1 OF 3 (PER LE NOTE E LE QUOTE MANCANTI VEDERE P/N 284422-1, FOGLIO 1 DI 3)

ITEM (VOCE)	DESCRIPTION (DESCRIZIONE)	MATERIAL (MATERIALE)	Q. TY (Q. TA')
1	HOUSING (BLOCCHETTO)	PA 66 GF COLOR BLUE (COLORE BLU)	1
2	SHORT CIRCUIT SPRING (MOLLA DI CORTO CIRCUITO)	STAINLESS STEEL (ACCIOIO INOX)	8

284422-3 AS SHOWN
 COME MOSTRATO

<small>THIS DRAWING IS A CONTROLLED DOCUMENT FOR TYCO ELECTRONICS CORPORATION. IT IS SUBJECT TO CHANGE AND THE CONTROLLING ENGINEERING ORGANIZATION SHOULD BE CONTACTED FOR THE LATEST REVISION.</small>		DWN: 04MAY2001 M. BARBERIS CHK: 04MAY2001 Q. CANUTO APVD: A. GENTA	tyco Electronics tyco Electronics AMP Italia S.p.A. C.so F.lli Cervi, 15 Collegno (TO)
DIMENSIONS: mm	TOLERANCES UNLESS OTHERWISE SPECIFIED: 0 PLC ±0.3 1 PLC ±0.2 2 PLC ±0.1 3 PLC ± 4 PLC ± ANGLES ±°	PRODUCT SPEC APPLICATION SPEC WEIGHT	NAME: 32 POSITIONS REC. HOUSING ASS'Y FOR AIRBAG SIZE: A3 CAGE CODE: 00779 DRAWING NO: C-284422 RESTRICTED TO:
MATERIAL SEE TABLE (VEDI TABELLA)	FINISH SEE TABLE (VEDI TABELLA)	CUSTOMER DRAWING	SCALE: 2:1 SHEET 3 OF 3 REV A2