

REVISED		REVISIONS			
NO	DATE	DESCRIPTION	BY	CHECKED	APP'D
A		ADDED ASSEMBLY DATE CODE			

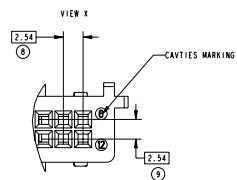

DESIGNATION	REP.	Q.	MATERIAL	TE FN	COLOR	CODING
SHIELD	1	1	PBT204FV		BLUE	
LEVER	2	1	PBT204FV	185341-2	BLACK	
SHIELD	1	1	PBT204FV		BROWN	
LEVER	2	1	PBT204FV	185341-1	BLACK	

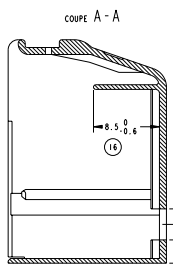
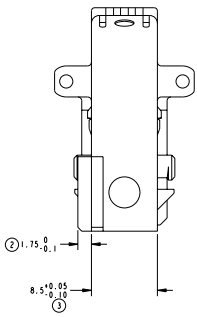
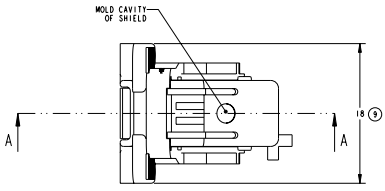
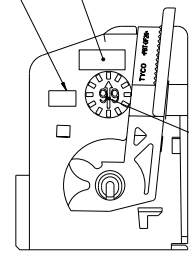
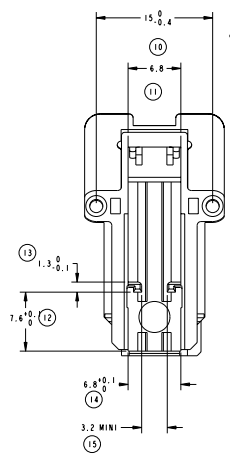
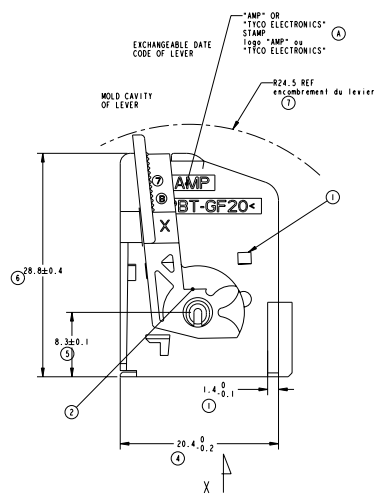

TYCO ELECTRONICS France SAS
 BP 30339, 95301 CERGY-PONTOISE Cedex

COVER + LEVER ASSY
 FOR MOS 12 POS 0 DEG

185341

DATE: 13/03/2007

BY: J. BOLLILLARD

APP'D: M. BOUILLARD

CUSTOMER DRAWING: /PLAN CLIENT NON RETENUE