

## HIGH EFFICIENCY ULTRAFAST DIODE

### MAIN PRODUCT CHARACTERISTICS

$I_{F(AV)}$	2 x 4A
$V_{RRM}$	200 V
$T_j$ (max)	175 °C
$V_F$ (max)	0.95 V
$t_{rr}$ (max)	20 ns

### FEATURES AND BENEFITS

- Suited for SMPS
- Low losses
- Low forward and reverse recovery times
- High surge current capability
- High junction temperature
- Insulated package: TO-220FPAB

### DESCRIPTION

Dual center tap rectifier suited for Switch Mode Power Supplies and High frequency DC to DC converters.

Packaged in DPAK, TO-220AB or TO-220FPAB. This device is intended for use in low voltage, high frequency inverters, free wheeling and polarity protection applications.

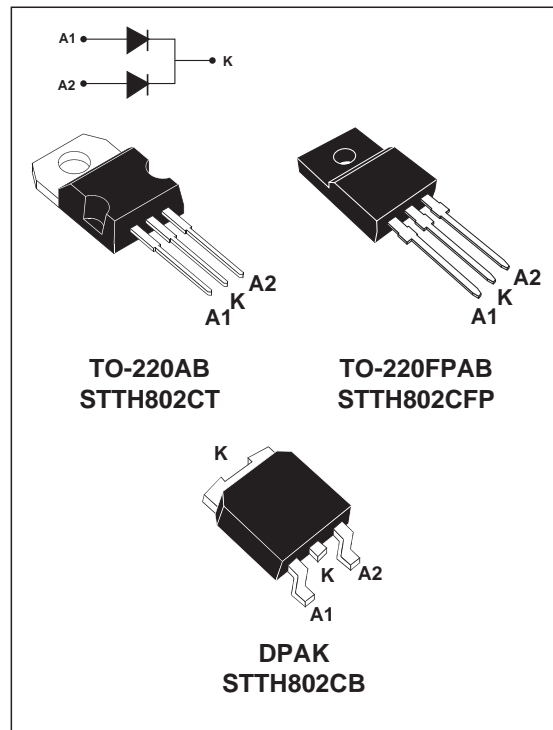

### ABSOLUTE RATINGS (limiting values)

Symbol	Parameter			Value	Unit	
$V_{RRM}$	Repetitive peak reverse voltage			200	V	
$I_{F(RMS)}$	RMS forward current	TO-220AB / TO-220FPAB / DPAK		10	A	
$I_{F(AV)}$	Average forward current $\delta = 0.5$	TO-220AB / DPAK	$T_c = 155^\circ\text{C}$	Per diode	4	A
		TO-220FPAB	$T_c = 145^\circ\text{C}$			
		TO-220AB / DPAK	$T_c = 150^\circ\text{C}$	Per device	8	A
		TO-220FPAB	$T_c = 130^\circ\text{C}$			
$I_{FSM}$	Surge non repetitive forward current		$t_p = 10 \text{ ms}$ Sinusoidal	50	A	
$T_{stg}$	Storage temperature range			- 65 + 175	°C	
$T_j$	Maximum operating junction temperature			175	°C	

## STTH802/CT/CB/CFP

### THERMAL PARAMETERS

Symbol	Parameter			Maximum	Unit
R <sub>th(j-c)</sub>	Junction to case	TO-220AB / DPAK	Per diode	4.0	°C/W
		TO-220FPAB		6.5	
		TO-220AB / DPAK	Total	2.5	
		TO-220FPAB		5	
R <sub>th(j-c)</sub>	Coupling	TO-220AB / DPAK		1	°C/W
		TO-220FPAB		3.5	

When the diodes 1 and 2 are used simultaneously:

$$\Delta T_j (\text{diode1}) = P(\text{diode1}) \times R_{th(j-c)} (\text{per diode}) + P(\text{diode2}) \times R_{th(c)}$$

### STATIC ELECTRICAL CHARACTERISTICS

Symbol	Parameter	Tests conditions		Min.	Typ.	Max.	Unit
I <sub>R</sub> <sup>*</sup>	Reverse leakage current	T <sub>j</sub> = 25°C	V <sub>R</sub> = V <sub>RRM</sub>			4	μA
		T <sub>j</sub> = 125°C			2	40	
V <sub>F</sub> <sup>**</sup>	Forward voltage drop	T <sub>j</sub> = 25°C	I <sub>F</sub> = 4 A			1.1	V
		T <sub>j</sub> = 125°C	I <sub>F</sub> = 4 A		0.81	0.95	
		T <sub>j</sub> = 25°C	I <sub>F</sub> = 8 A			1.25	
		T <sub>j</sub> = 125°C	I <sub>F</sub> = 8 A		0.95	1.1	

Pulse test: \* t<sub>p</sub> = 5ms, δ < 2%

\*\* t<sub>p</sub> = 380μs, δ < 2%

To evaluate the maximum conduction losses use the following equation :

$$P = 0.80 \times I_{F(AV)} + 0.037 I_{F(RMS)}^2$$

### DYNAMIC ELECTRICAL CHARACTERISTICS

Symbol	Parameter	Tests conditions		Min.	Typ.	Max.	Unit
t <sub>rr</sub>	Reverse recovery time	T <sub>j</sub> = 25°C	I <sub>F</sub> = 0.5 A I <sub>rr</sub> = 0.25 A I <sub>R</sub> = 1A		13	20	ns
t <sub>fr</sub>	Forward recovery time	T <sub>j</sub> = 25°C	I <sub>F</sub> = 4 A dI <sub>F</sub> /dt = 100 A/μs V <sub>FR</sub> = 1.1 x V <sub>Fmax</sub>		50		ns
V <sub>FP</sub>	Forward recovery voltage	T <sub>j</sub> = 25°C	I <sub>F</sub> = 4 A dI <sub>F</sub> /dt = 100 A/μs		2.4		V

**Fig. 1:** Average forward power dissipation versus average forward current (per diode).

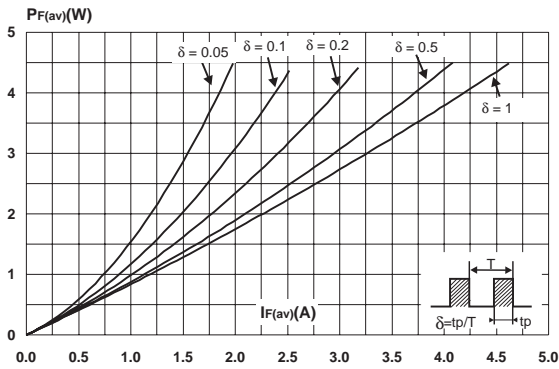

**Fig. 2:** Peak current versus form factor (per diode).

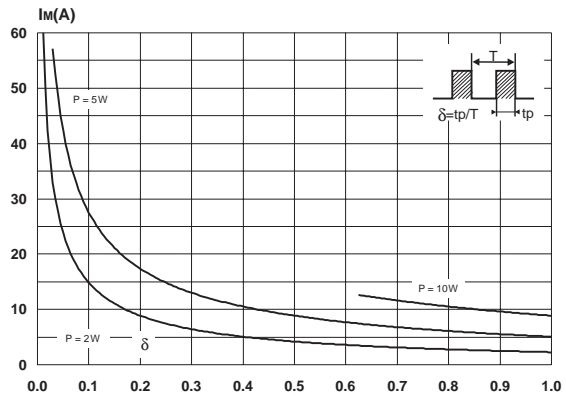

**Fig. 3:** Forward voltage drop versus forward current (per diode).

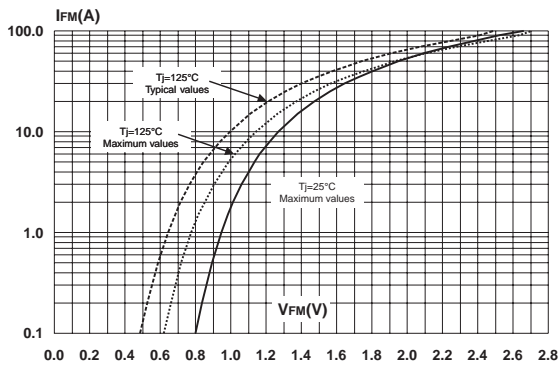

**Fig. 4-1:** Relative variation of thermal impedance junction to case versus pulse duration (TO-220AB, DPAK).

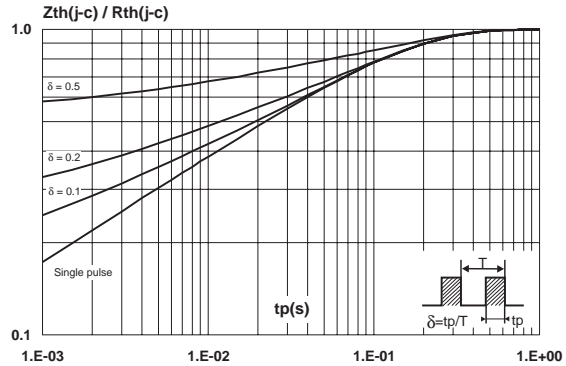

**Fig. 4-2:** Relative variation of thermal impedance junction to case versus duration (TO-220FPAB).

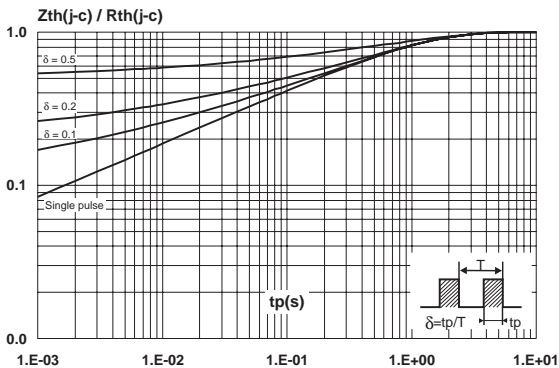

**Fig. 5-1:** Non repetitive surge peak forward current versus overload duration per diode (TO-220AB, DPAK).

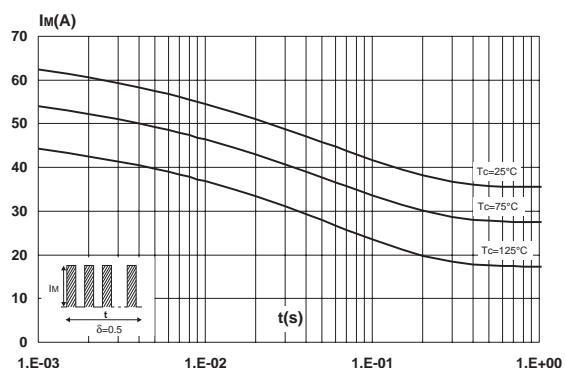

**Fig. 5-2:** Non repetitive surge peak forward current versus overload duration per diode (TO-220FPAB).

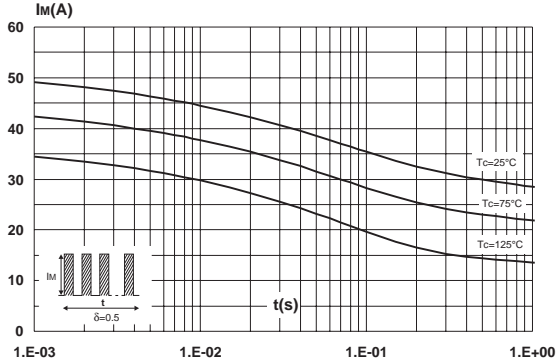

**Fig. 6:** Average forward current versus ambient temperature ( $\delta = 0.5$ , per diode).

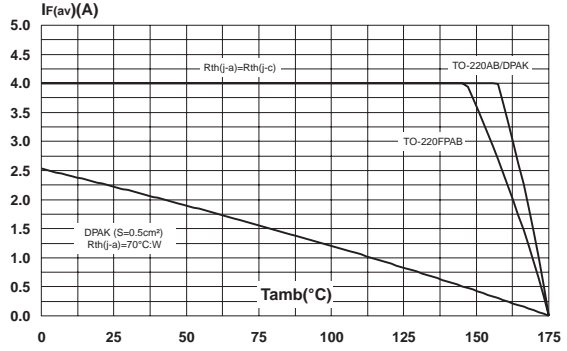

**Fig. 7:** Junction capacitance versus reverse voltage applied (typical values, per diode).

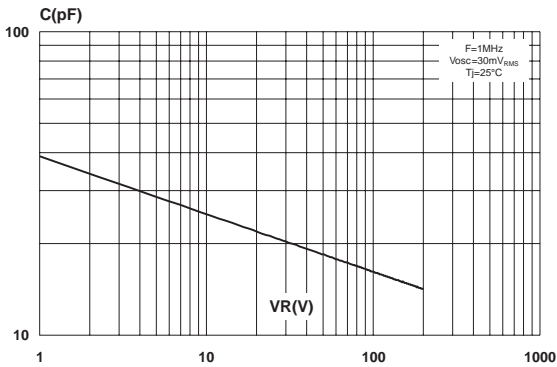

**Fig. 8:** Reverse recovery charges versus dIF/dt (90% confidence, per diode).

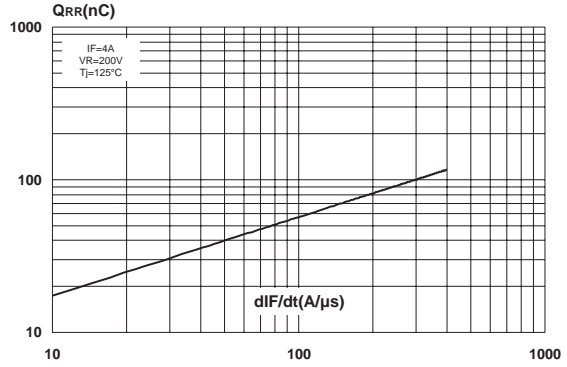

**Fig. 9:** Peak reverse recovery current versus dIF/dt (90% confidence, per diode).

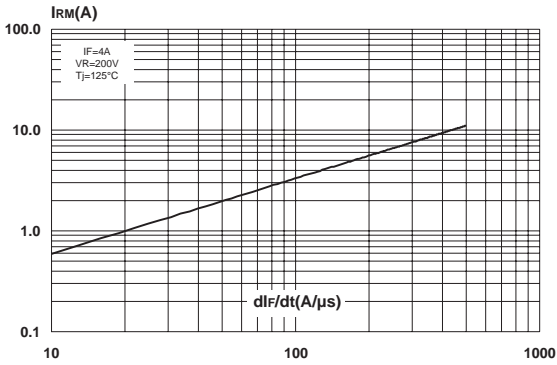

**Fig. 10:** Dynamic parameters versus junction temperature.

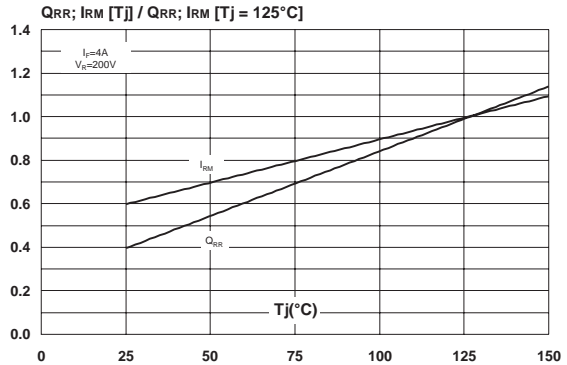

**Fig. 11:** Thermal resistance junction to ambient versus copper surface under tab (Epoxy printed circuit board FR4, copper thickness: 35µm) for DPAK.

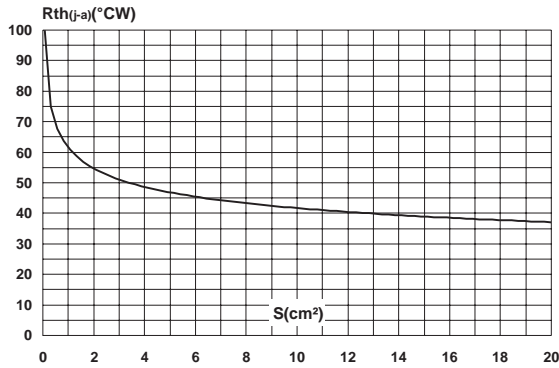

**PACKAGE MECHANICAL DATA**  
TO-220AB

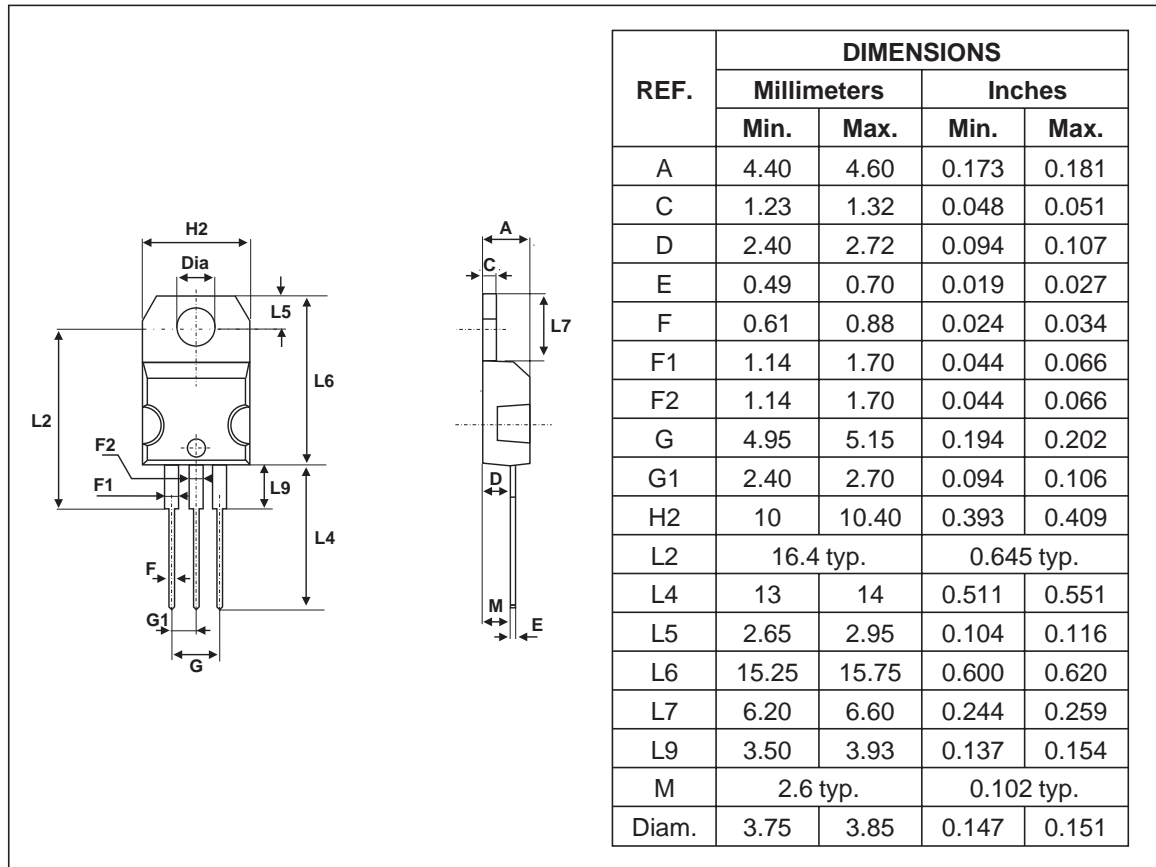

**PACKAGE MECHANICAL DATA**  
DPAK

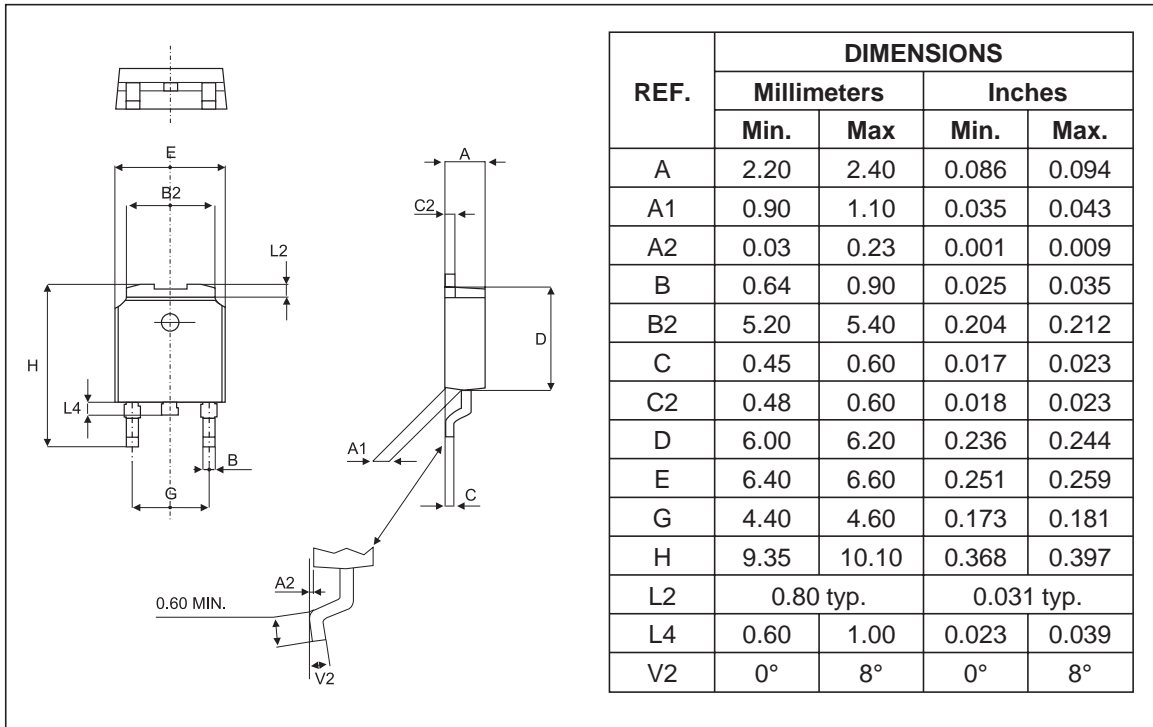

**FOOTPRINT**

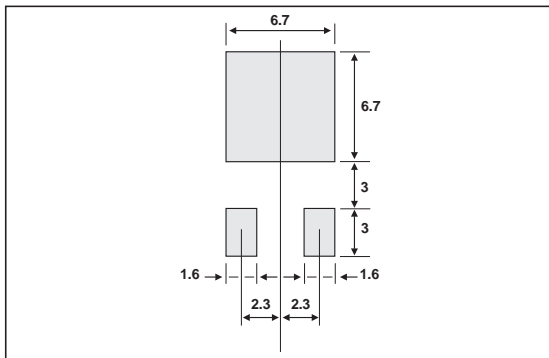

**PACKAGE MECHANICAL DATA**  
 TO-220FPAB

REF.	DIMENSIONS			
	Millimeters		Inches	
	Min.	Max.	Min.	Max.
A	4.4	4.6	0.173	0.181
B	2.5	2.7	0.098	0.106
D	2.5	2.75	0.098	0.108
E	0.45	0.70	0.018	0.027
F	0.75	1	0.030	0.039
F1	1.15	1.70	0.045	0.067
F2	1.15	1.70	0.045	0.067
G	4.95	5.20	0.195	0.205
G1	2.4	2.7	0.094	0.106
H	10	10.4	0.393	0.409
L2	16 Typ.		0.63 Typ.	
L3	28.6	30.6	1.126	1.205
L4	9.8	10.6	0.386	0.417
L5	2.9	3.6	0.114	0.142
L6	15.9	16.4	0.626	0.646
L7	9.00	9.30	0.354	0.366
Dia.	3.00	3.20	0.118	0.126

Ordering code	Marking	Package	Weight	Base qty	Delivery mode
STTH802CT	STTH802CT	TO-220AB	2.23 g	50	Tube
STTH802CB	STTH802CB	DPAK	0.3 g	75	Tube
STTH802CB-TR	STTH802CB	DPAK	0.3 g	2500	Tape & reel
STTH802CFP	STTH802CFP	TO-220FPAB	2.0 g	50	Tube

- Cooling method: by conduction (method C)
- Recommended torque value (TO-220AB): 0.8 N.m
- Maximum torque value (TO-220AB): 1.0 N.m
- Recommended torque value (TO-220FPAB): 0.55 N.m
- Maximum torque value (TO-220FPAB): 0.7 N.m
- Epoxy meets UL 94,V0

Information furnished is believed to be accurate and reliable. However, STMicroelectronics assumes no responsibility for the consequences of use of such information nor for any infringement of patents or other rights of third parties which may result from its use. No license is granted by implication or otherwise under any patent or patent rights of STMicroelectronics. Specifications mentioned in this publication are subject to change without notice. This publication supersedes and replaces all information previously supplied. STMicroelectronics products are not authorized for use as critical components in life support devices or systems without express written approval of STMicroelectronics.

The ST logo is a registered trademark of STMicroelectronics

© 2002 STMicroelectronics - Printed in Italy - All rights reserved.

STMicroelectronics GROUP OF COMPANIES

Australia - Brazil - Canada - China - Finland - France - Germany  
Hong Kong - India - Israel - Italy - Japan - Malaysia - Malta - Morocco - Singapore  
Spain - Sweden - Switzerland - United Kingdom - United States.

<http://www.st.com>