



# STPS30L40CG/CT/CW

## LOW DROP POWER SCHOTTKY RECTIFIER

### MAIN PRODUCTS CHARACTERISTICS

$I_{F(AV)}$	2 x 15 A
$V_{RRM}$	40 V
$T_j$ (max)	150 °C
$V_F$ (max)	0.50 V

### FEATURES AND BENEFITS

- VERY SMALL CONDUCTION LOSSES
- NEGLIGIBLE SWITCHING LOSSES
- LOW FORWARD VOLTAGE DROP
- LOW THERMAL RESISTANCE
- AVALANCHE CAPABILITY SPECIFIED

### DESCRIPTION

Dual center tap schottky rectifiers suited for Switched Mode Power Supplies and high frequency DC to DC converters.

Packaged in TO-247, TO-220AB and D<sup>2</sup>PAK these devices are intended for use in low voltage, high frequency inverters, free-wheeling and polarity protection applications.

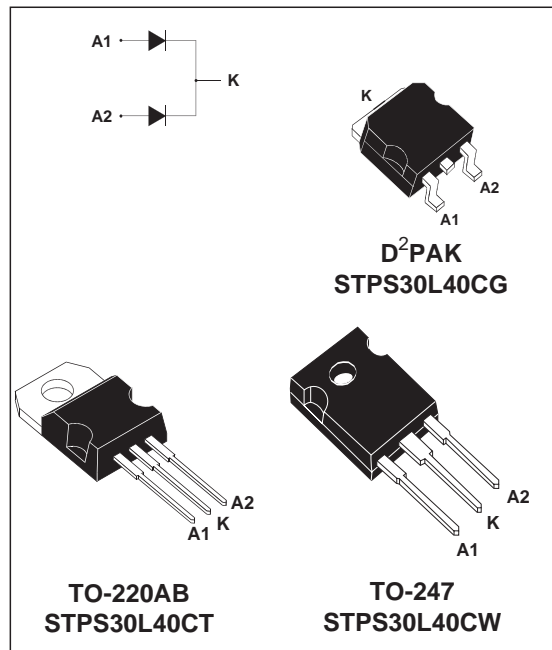

### ABSOLUTE RATINGS (limiting values, per diode)

Symbol	Parameter		Value	Unit
$V_{RRM}$	Repetitive peak reverse voltage		40	V
$I_{F(RMS)}$	RMS forward current		30	A
$I_{F(AV)}$	Average forward current	$T_c = 135^\circ\text{C}$ $\delta = 0.5$	Per diode 15 Per device 30	A
$I_{FSM}$	Surge non repetitive forward current	$t_p = 10$ ms Sinusoidal	220	A
$I_{RRM}$	Repetitive peak reverse current	$t_p = 2$ $\mu\text{s}$ square $F=1\text{kHz}$	1	A
$I_{RSM}$	Non repetitive peak reverse current	$t_p = 100$ $\mu\text{s}$ square	3	A
$P_{ARM}$	Repetitive peak avalanche power	$t_p = 1$ $\mu\text{s}$ $T_j = 25^\circ\text{C}$	6000	W
$T_{stg}$	Storage temperature range		- 65 to + 150	°C
$T_j$	Maximum operating junction temperature *		150	°C
$dV/dt$	Critical rate of rise of reverse voltage		10000	V/ $\mu\text{s}$

\* :  $\frac{dP_{tot}}{dT_j} < \frac{1}{R_{th}(j-a)}$  thermal runaway condition for a diode on its own heatsink

## STPS30L40CG/CT/CW

### THERMAL RESISTANCES

Symbol	Parameter		Value	Unit
$R_{th(j-c)}$	Junction to case	Per diode	1.60	$^{\circ}\text{C}/\text{W}$
		Total	0.85	
$R_{th(c)}$		Coupling	0.10	$^{\circ}\text{C}/\text{W}$

When the diodes 1 and 2 are used simultaneously :  
 $\Delta T_{j(\text{diode } 1)} = P(\text{diode } 1) \times R_{th(j-c)}(\text{Per diode}) + P(\text{diode } 2) \times R_{th(c)}$

### STATIC ELECTRICAL CHARACTERISTICS (per diode)

Symbol	Parameter	Tests Conditions		Min.	Typ.	Max.	Unit
$I_R^*$	Reverse leakage current	$T_j = 25^{\circ}\text{C}$	$V_R = V_{RRM}$			360	$\mu\text{A}$
		$T_j = 100^{\circ}\text{C}$			20	50	mA
$V_F^*$	Forward voltage drop	$T_j = 25^{\circ}\text{C}$	$I_F = 15\text{ A}$			0.55	V
		$T_j = 125^{\circ}\text{C}$	$I_F = 15\text{ A}$		0.42	0.50	
		$T_j = 25^{\circ}\text{C}$	$I_F = 30\text{ A}$			0.74	
		$T_j = 125^{\circ}\text{C}$	$I_F = 30\text{ A}$		0.59	0.67	

Pulse test : \*  $t_p = 380\ \mu\text{s}$ ,  $\delta < 2\%$

To evaluate the conduction losses use the following equation :  
 $P = 0.330 \times I_{F(AV)} + 0.011 I_{F(RMS)}^2$

**Fig. 1:** Average forward power dissipation versus average forward current (per diode).

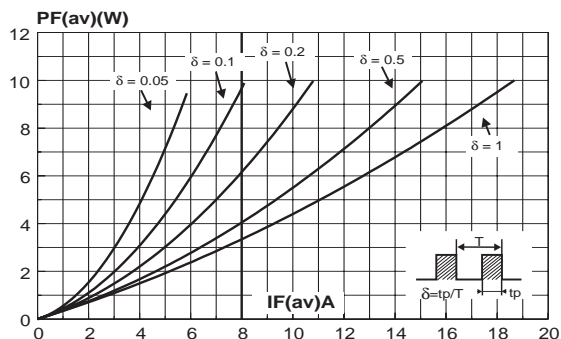

**Fig. 2:** Average current versus ambient temperature ( $\delta=0.5$ ) (per diode).

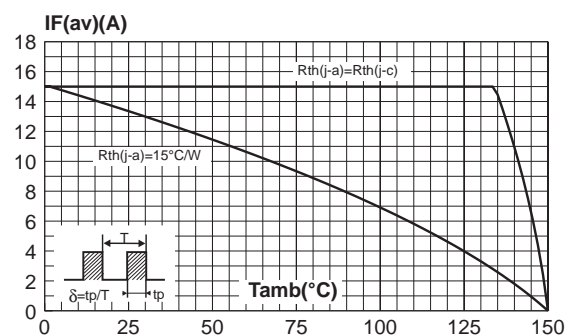

**Fig. 3:** Normalized avalanche power derating versus pulse duration.

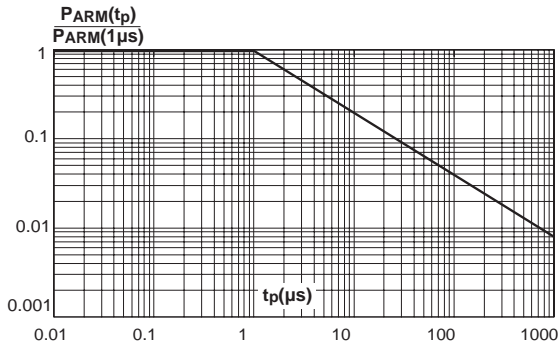

**Fig. 4:** Normalized avalanche power derating versus junction temperature.

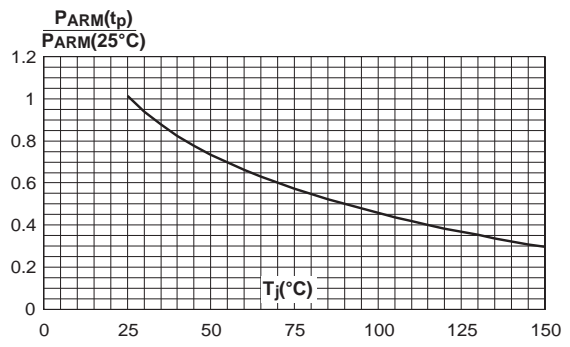

**Fig. 5:** Non repetitive surge peak forward current versus overload duration (maximum values) (per diode).

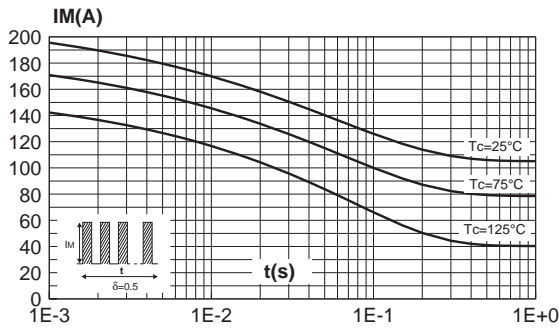

**Fig. 6:** Relative variation of thermal transient impedance junction to case versus pulse duration.

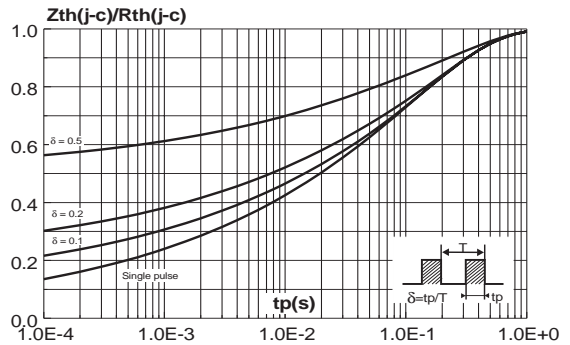

**Fig. 7:** Reverse leakage current versus reverse voltage applied (typical values) (per diode).

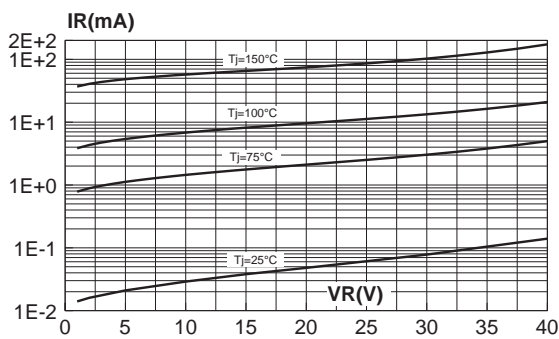

**Fig. 8:** Junction capacitance versus reverse voltage applied (typical values) (per diode).

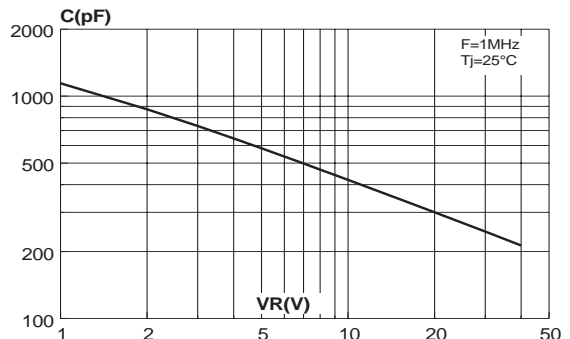

**Fig. 9:** Forward voltage drop versus forward current (maximum values) (per diode).

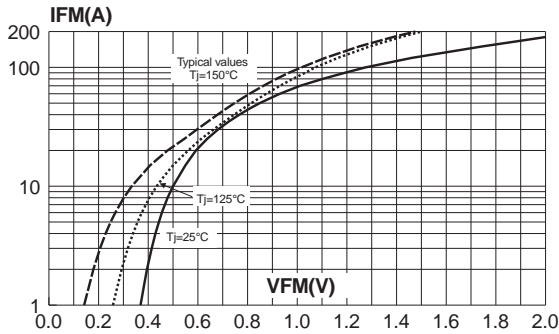

**Fig. 10:** Thermal resistance junction to ambient versus copper surface under tab (Epoxy printed circuit board FR4, copper thickness: 35µm) (STPS30L40CG only).

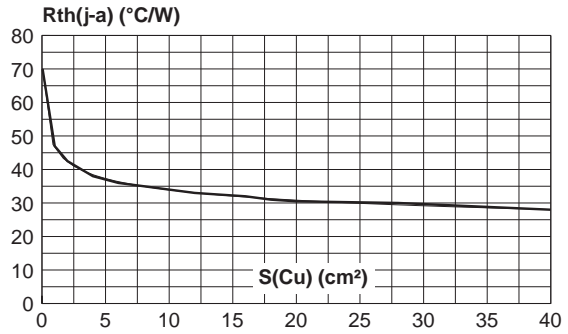

**PACKAGE MECHANICAL DATA**  
TO-220AB

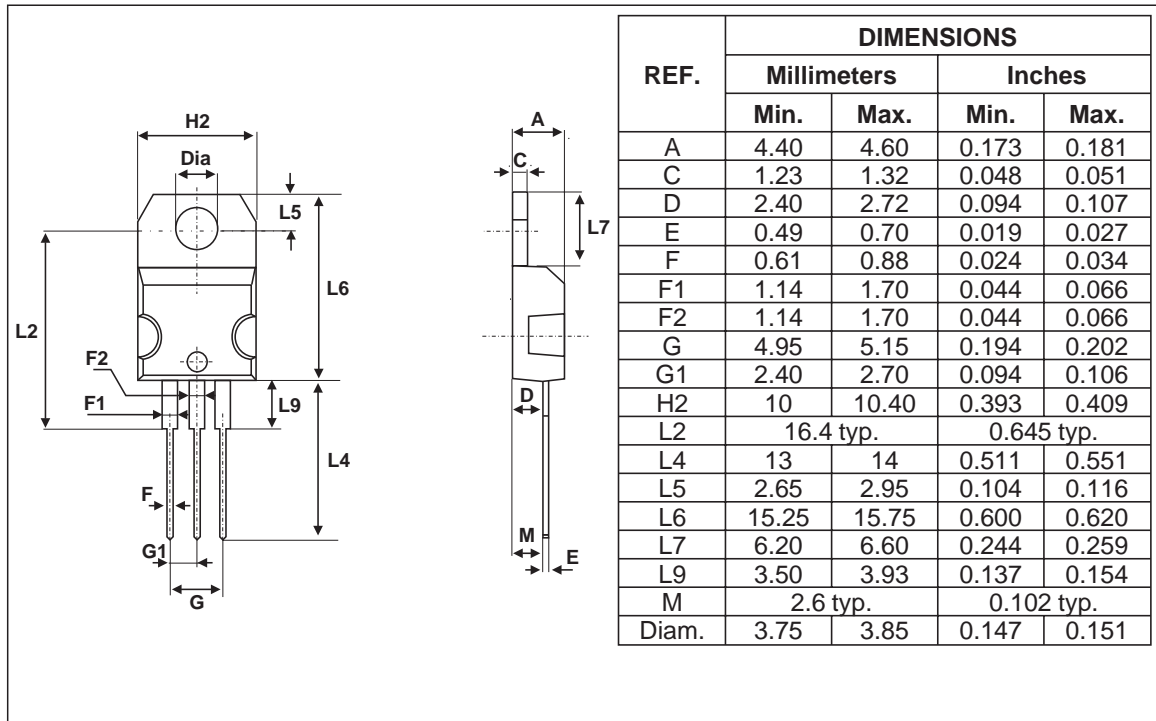

- COOLING METHOD : C
- RECOMMENDED TORQUE VALUE : 0.55 M.N
- MAXIMUM TORQUE VALUE : 0.70 M.N

**PACKAGE MECHANICAL DATA**  
D<sup>2</sup>PAK

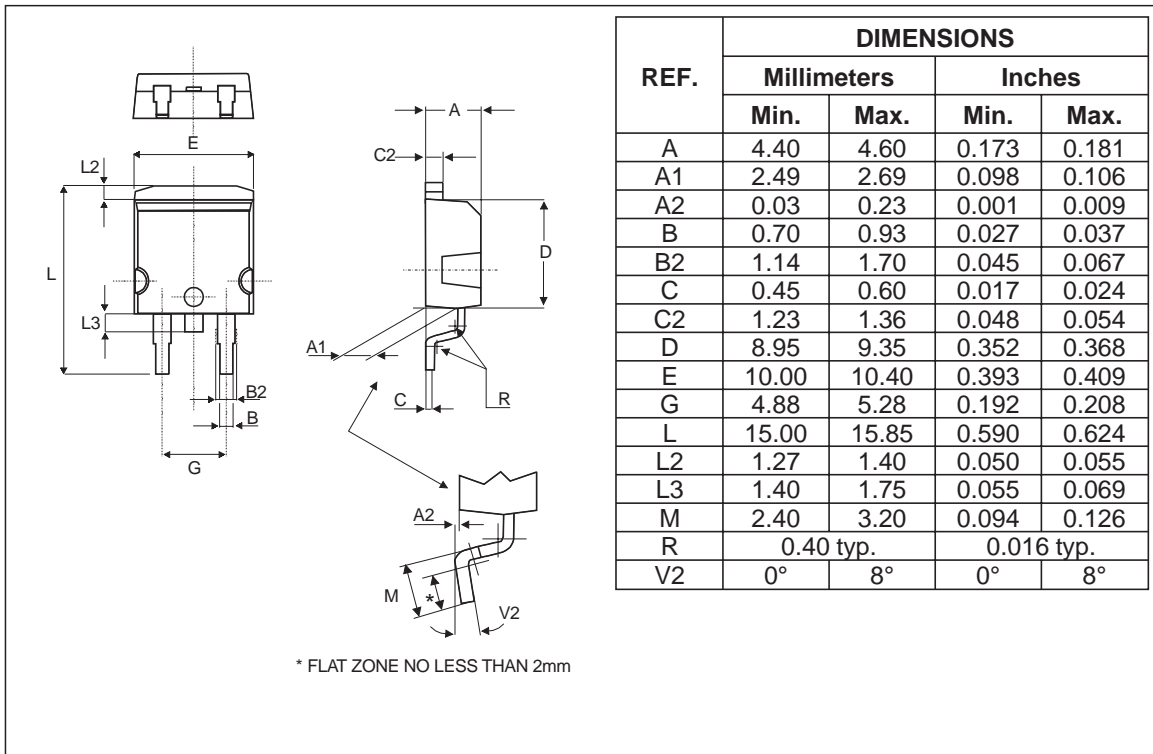

• COOLING METHOD : BY CONDUCTION  
(METHOD C)

**FOOT PRINT (in millimeters)**  
D<sup>2</sup>PAK

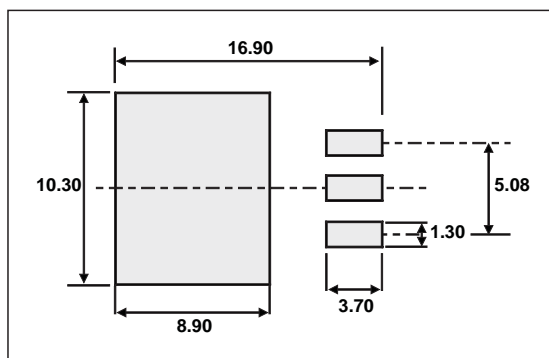

# STPS30L40CG/CT/CW

## PACKAGE MECHANICAL DATA TO-247

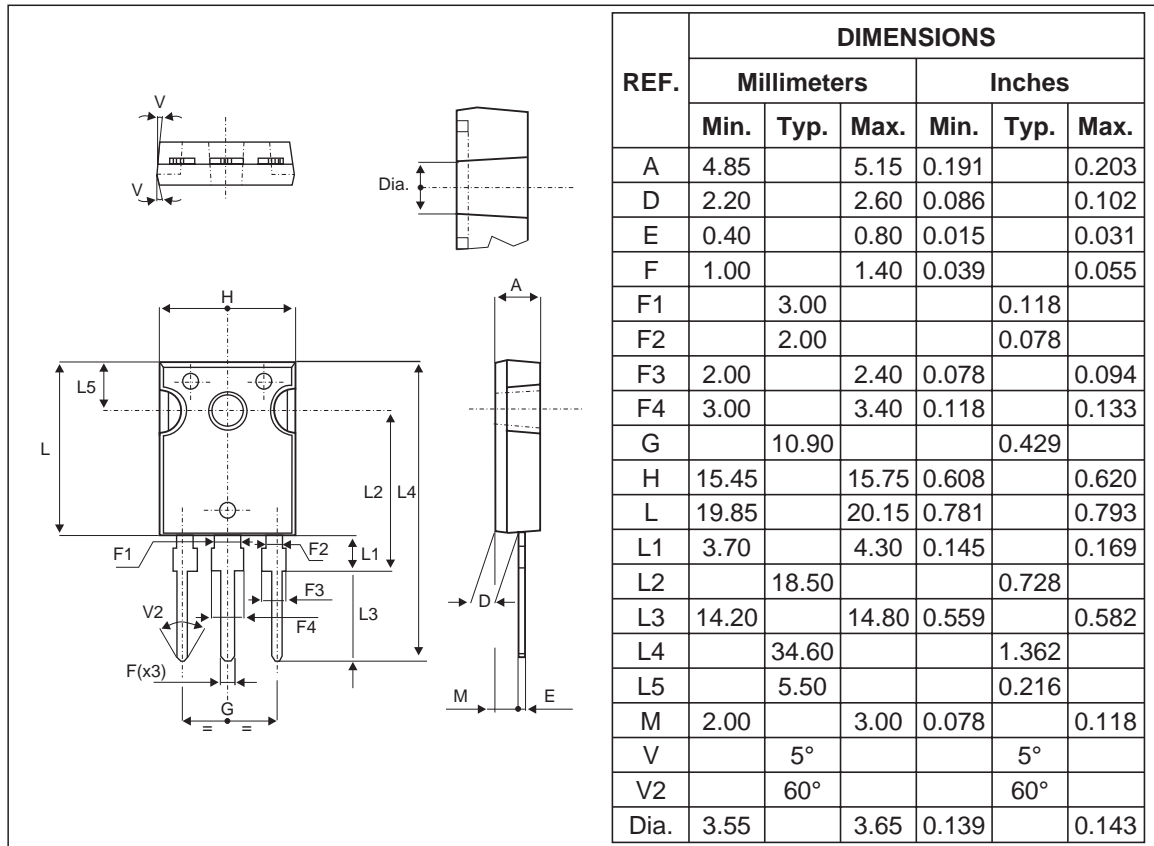

- COOLING METHOD : C
- RECOMMENDED TORQUE VALUE : 0.8M.N
- MAXIMUM TORQUE VALUE : 1.0M.N

Ordering type	Marking	Package	Weight	Base qty	Delivery mode
STPS30L40CT	STPS30L40CT	TO-220AB	2g	50	Tube
STPS30L40CG	STPS30L40CG	D <sup>2</sup> PAK	1.8g	50	Tube
STPS30L40CG-TR	STPS30L40CG	D <sup>2</sup> PAK	1.8g	500	Tape & reel
STPS30L40CW	STPS30L40CW	TO-247	4.4g	30	Tube

- EPOXY MEETS UL94,V0

Information furnished is believed to be accurate and reliable. However, STMicroelectronics assumes no responsibility for the consequences of use of such information nor for any infringement of patents or other rights of third parties which may result from its use. No license is granted by implication or otherwise under any patent or patent rights of STMicroelectronics. Specifications mentioned in this publication are subject to change without notice. This publication supersedes and replaces all information previously supplied. STMicroelectronics products are not authorized for use as critical components in life support devices or systems without express written approval of STMicroelectronics.

The ST logo is a registered trademark of STMicroelectronics

© 2003 STMicroelectronics - Printed in Italy - All rights reserved.

STMicroelectronics GROUP OF COMPANIES

Australia - Brazil - Canada - China - Finland - France - Germany  
 Hong Kong - India - Israel - Italy - Japan - Malaysia - Malta - Morocco - Singapore  
 Spain - Sweden - Switzerland - United Kingdom - United States.

<http://www.st.com>