

## High voltage power Schottky rectifier

### Main product characteristics

$I_{F(AV)}$	2 x 5 A
$V_{RRM}$	170 V
$T_j$	175° C
$V_F$ (typ)	0.69 V

### Features and benefits

- High junction temperature capability
- Good trade-off between leakage current and forward voltage drop
- Low leakage current
- Avalanche capability specified

### Description

Dual centre tab Schottky rectifier designed for high frequency switch mode power supplies.

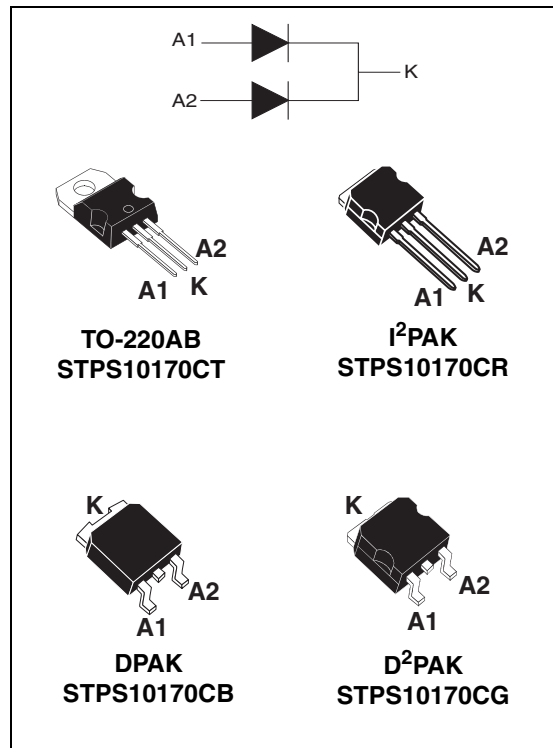

### Order codes

Part Number	Marking
STPS10170CT	STPS10170CT
STPS10170CG	STPS10170CG
STPS10170CG-TR	STPS10170CG
STPS10170CR	STPS10170CR
STPS10170CB	PS10170CB
STPS10170CB-TR	PS10170CB

# 1 Characteristics

**Table 1. Absolute ratings (limiting values per diode,  $T_{amb} = 25^{\circ}C$  unless otherwise specified)**

Symbol	Parameter			Value	Unit
$V_{RRM}$	Repetitive peak reverse voltage			170	V
$I_{F(RMS)}$	RMS forward current			10	A
$I_{F(AV)}$	Average forward current, $\delta = 0.5$	$T_c = 155^{\circ}C$	Per diode	5	A
			Total package	10	
$I_{FSM}$	Surge non repetitive forward current	$t_p = 10$ ms Sinusoidal		75	A
$P_{ARM}$	Relative peak avalanche power	$T_j = 25^{\circ}C$	$t_p = 1\mu s$	3100	W
$T_{stg}$	Storage temperature range			-65 to + 175	$^{\circ}C$
$T_j$	Maximum operating junction temperature <sup>(1)</sup>			175	$^{\circ}C$
dV/dt	Critical rate of rise of reverse voltage			10 000	V/ $\mu s$

1.  $\frac{dP_{tot}}{dT_j} < \frac{1}{R_{th(j-a)}}$  thermal runaway condition for a diode on its own heatsink

**Table 2. Thermal parameters**

Symbol	Parameter		Value	Unit
$R_{th(j-c)}$	Junction to case	Per diode	4	$^{\circ}C/W$
		Total	2.4	
$R_{th(c)}$	Coupling		0.7	

**Table 3. Static electrical characteristics**

Symbol	Parameter	Test conditions		Min.	Typ	Max.	Unit
$I_R^{(1)}$	Reverse leakage current	$T_j = 25^{\circ}C$	$V_R = V_{RRM}$			10	$\mu A$
		$T_j = 125^{\circ}C$				10	mA
$V_F^{(2)}$	Forward voltage drop	$T_j = 25^{\circ}C$	$I_F = 5$ A			0.92	V
		$T_j = 125^{\circ}C$			0.69	0.75	
		$T_j = 25^{\circ}C$	$I_F = 10$ A			1	
		$T_j = 125^{\circ}C$			0.79	0.85	

1. Pulse test:  $t_p = 5$  ms,  $\delta < 2\%$

2. Pulse test:  $t_p = 380 \mu s$ ,  $\delta < 2\%$

To evaluate the conduction losses use the following equation:

$$P = 0.65 \times I_{F(AV)} + 0.02 \times I_{F(RMS)}^2$$

**Figure 1. Conduction losses versus average forward current (per diode)**

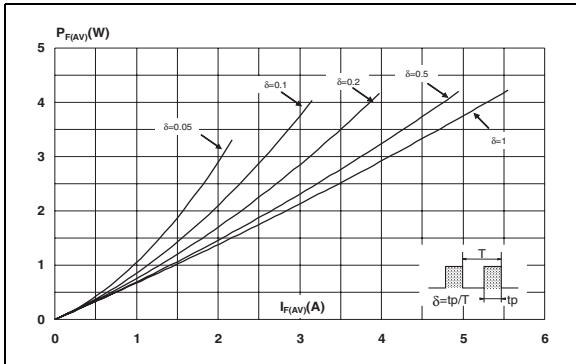

**Figure 2. Average forward current versus ambient temperature ( $\delta = 0.5$ , per diode)**

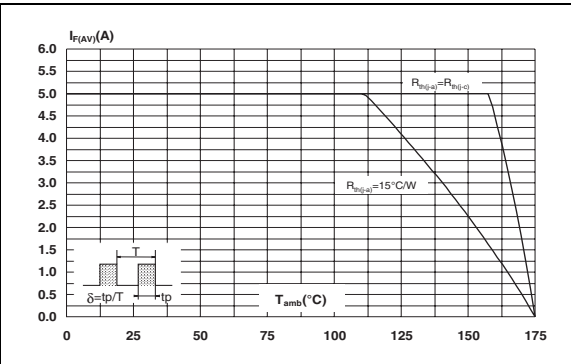

**Figure 3. Normalized avalanche power derating versus pulse duration**

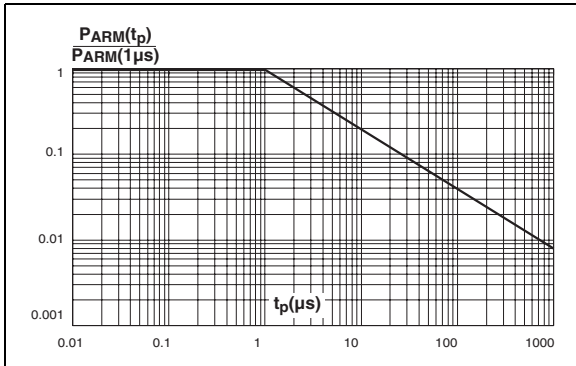

**Figure 4. Normalized avalanche power derating versus junction temperature**

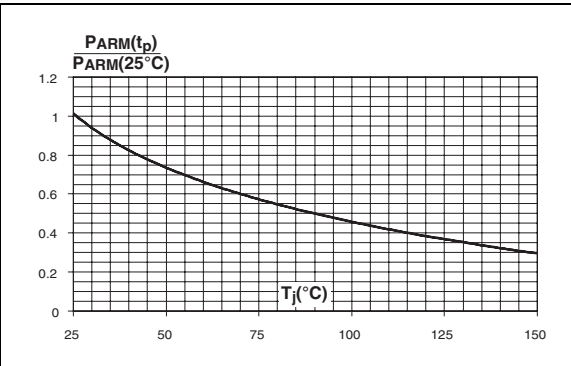

**Figure 5. Non repetitive surge peak forward current versus overload duration (maximum values, per diode)**

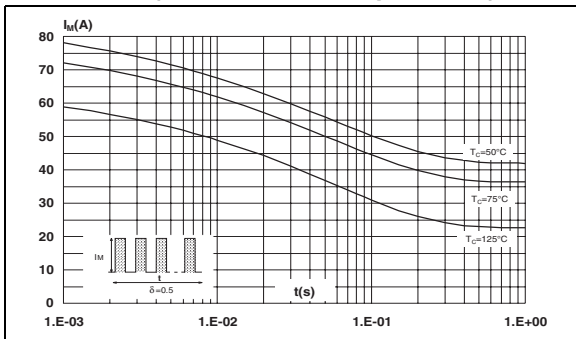

**Figure 6. Relative variation of thermal impedance, junction to case versus pulse duration**

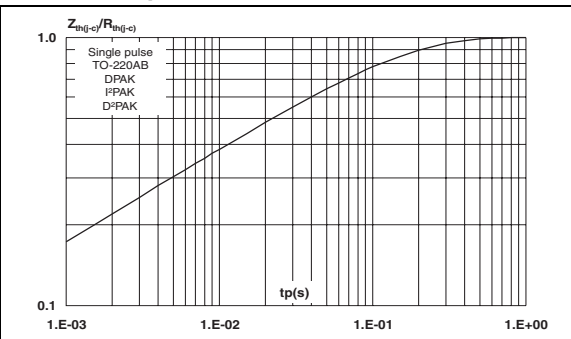

**Figure 7. Reverse leakage current versus reverse voltage applied (typical values, per diode)**

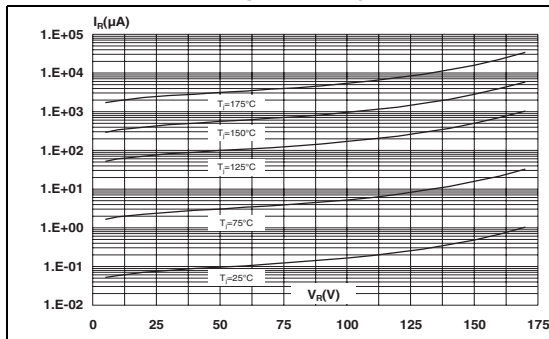

**Figure 8. Junction capacitance versus reverse voltage applied (typical values, per diode)**

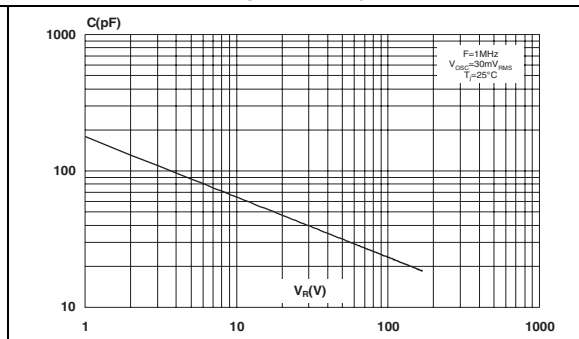

**Figure 9. Forward voltage drop versus forward current (per diode)**

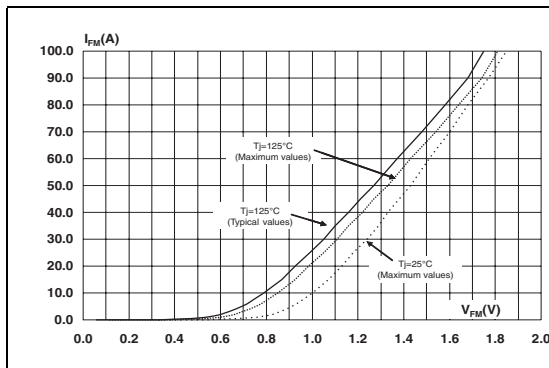

**Figure 10. Thermal resistance junction to ambient versus copper surface area under tab (epoxy printed board FR4, Cu = 35 μm - DPAK)**

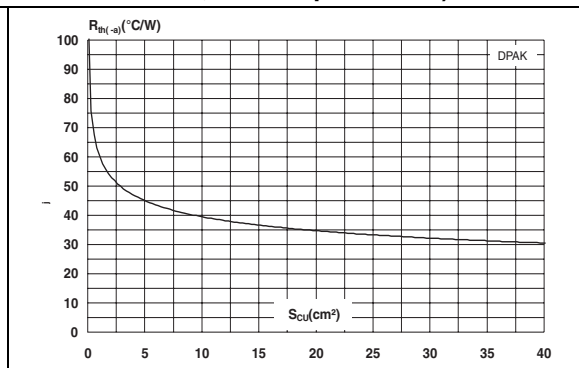

**Figure 11. Thermal resistance junction to ambient versus copper surface area under tab (epoxy printed board FR4, Cu = 35 μm - D<sup>2</sup>PAK)**

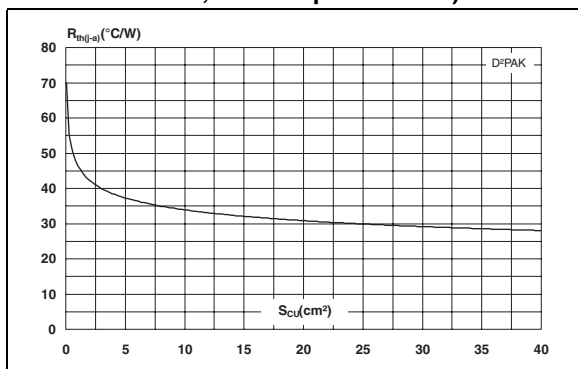

## 2 Package dimensions

Epoxy meets UL94, V0

**Table 4. T0-220AB dimensions**

Ref.	Dimensions			
	Millimeters		Inches	
	Min.	Max.	Min.	Max.
A	4.40	4.60	0.173	0.181
C	1.23	1.32	0.048	0.051
D	2.40	2.72	0.094	0.107
E	0.49	0.70	0.019	0.027
F	0.61	0.88	0.024	0.034
F1	1.14	1.70	0.044	0.066
F2	1.14	1.70	0.044	0.066
G	4.95	5.15	0.194	0.202
G1	2.40	2.70	0.094	0.106
H2	10	10.40	0.393	0.409
L2	16.4 typ.		0.645 typ.	
L4	13	14	0.511	0.551
L5	2.65	2.95	0.104	0.116
L6	15.25	15.75	0.600	0.620
L7	6.20	6.60	0.244	0.259
L9	3.50	3.93	0.137	0.154
M	2.6 typ.		0.102 typ.	
Diam.	3.75	3.85	0.147	0.151

Table 5. I<sup>2</sup>PAK dimensions

Ref.	Dimensions			
	Millimeters		Inches	
	Min.	Max.	Min.	Max.
A	4.40	4.60	0.173	0.181
A1	2.40	2.72	0.094	0.107
b	0.61	0.88	0.024	0.035
b1	1.14	1.70	0.044	0.067
c	0.49	0.70	0.019	0.028
c2	1.23	1.32	0.048	0.052
D	8.95	9.35	0.352	0.368
e	2.40	2.70	0.094	0.106
e1	4.95	5.15	0.195	0.203
E	10	10.40	0.394	0.409
L	13	14	0.512	0.551
L1	3.50	3.93	0.138	0.155
L2	1.27	1.40	0.050	0.055

Table 6. DPAK dimensions

Ref.	Dimensions			
	Millimeters		Inches	
	Min.	Max.	Min.	Max.
A	2.20	2.40	0.086	0.094
A1	0.90	1.10	0.035	0.043
A2	0.03	0.23	0.001	0.009
B	0.64	0.90	0.025	0.035
B2	5.20	5.40	0.204	0.212
C	0.45	0.60	0.017	0.023
C2	0.48	0.60	0.018	0.023
D	6.00	6.20	0.236	0.244
E	6.40	6.60	0.251	0.259
G	4.40	4.60	0.173	0.181
H	9.35	10.10	0.368	0.397
L2	0.80 typ.		0.031 typ.	
L4	0.60	1.00	0.023	0.039
V2	0°	8°	0°	8°

Figure 12. DPAK footprint (dimensions in mm)

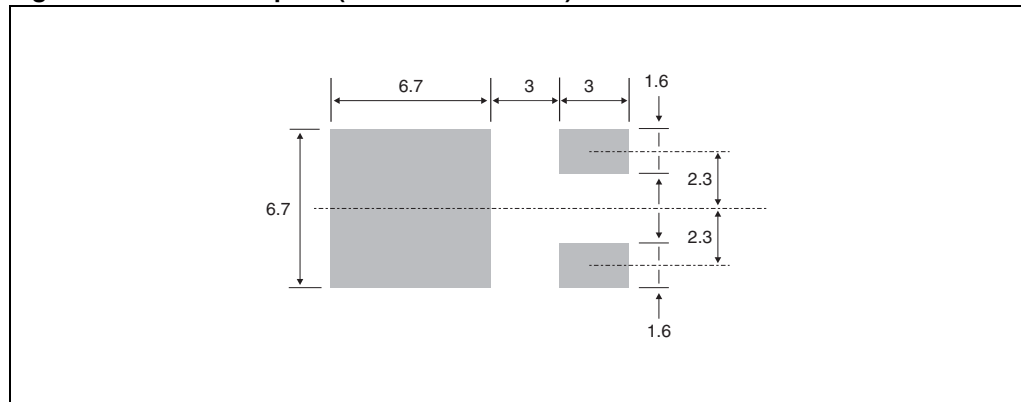
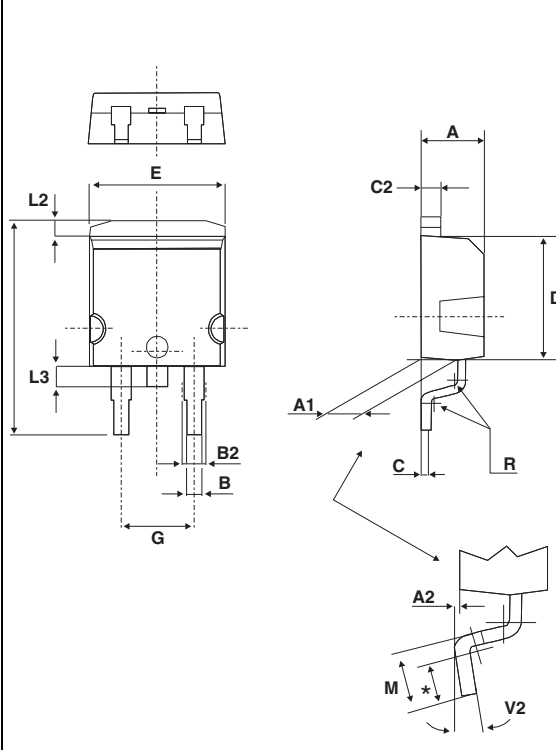

Table 7. D<sup>2</sup>PAK dimensions



Ref.	Dimensions			
	Millimeters		Inches	
	Min.	Max.	Min.	Max.
A	4.40	4.60	0.173	0.181
A1	2.49	2.69	0.098	0.106
A2	0.03	0.23	0.001	0.009
B	0.70	0.93	0.027	0.037
B2	1.14	1.70	0.045	0.067
C	0.45	0.60	0.017	0.024
C2	1.23	1.36	0.048	0.054
D	8.95	9.35	0.352	0.368
E	10.00	10.40	0.393	0.409
G	4.88	5.28	0.192	0.208
L	15.00	15.85	0.590	0.624
L2	1.27	1.40	0.050	0.055
L3	1.40	1.75	0.055	0.069
M	2.40	3.20	0.094	0.126
R	0.40 typ.		0.016 typ.	
V2	0°	8°	0°	8°

\* FLAT ZONE NO LESS THAN 2mm

Figure 13. D<sup>2</sup>PAK footprint (dimensions in mm)

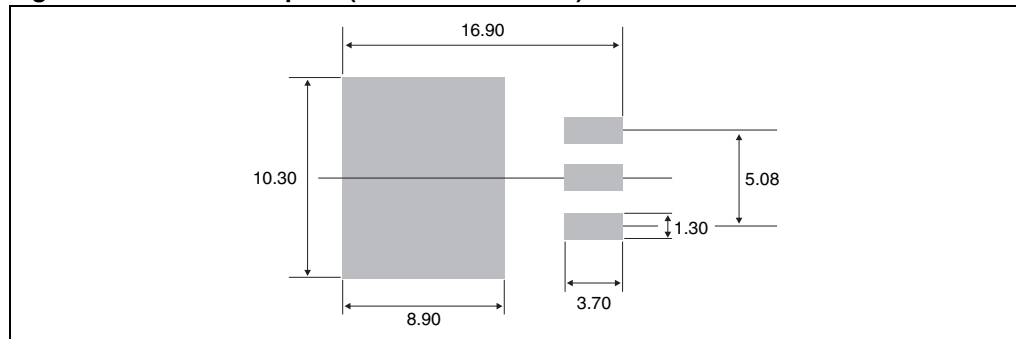

In order to meet environmental requirements, ST offers these devices in ECOPACK® packages. These packages have a lead-free second level interconnect. The category of second level interconnect is marked on the package and on the inner box label, in compliance with JEDEC Standard JESD97. The maximum ratings related to soldering conditions are also marked on the inner box label. ECOPACK is an ST trademark. ECOPACK specifications are available at: [www.st.com](http://www.st.com).



### 3 Ordering information

Part number	Marking	Package	Weight	Base qty	Delivery mode
STPS10170CT	STPS10170CT	TO-220AB	2.23 g	50	Tube
STPS10170CG	STPS10170CG	D <sup>2</sup> PAK	1.48 g	50	Tube
STPS10170CG-TR	STPS10170CG	D <sup>2</sup> PAK	1.48 g	1000	Tape and reel
STPS10170CB	PS10170CB	DPAK	0.3 g	75	Tube
STPS10170CB-TR	PS10170CB	DPAK	0.3 g	2500	Tape and reel
STPS10170CR	STPS10170CR	I <sup>2</sup> PAK	1.49 g	50	Tube

### 4 Revision history

Date	Revision	Description of changes
13-Jul-2006	1	First issue.

**Please Read Carefully:**

Information in this document is provided solely in connection with ST products. STMicroelectronics NV and its subsidiaries ("ST") reserve the right to make changes, corrections, modifications or improvements, to this document, and the products and services described herein at any time, without notice.

All ST products are sold pursuant to ST's terms and conditions of sale.

Purchasers are solely responsible for the choice, selection and use of the ST products and services described herein, and ST assumes no liability whatsoever relating to the choice, selection or use of the ST products and services described herein.

No license, express or implied, by estoppel or otherwise, to any intellectual property rights is granted under this document. If any part of this document refers to any third party products or services it shall not be deemed a license grant by ST for the use of such third party products or services, or any intellectual property contained therein or considered as a warranty covering the use in any manner whatsoever of such third party products or services or any intellectual property contained therein.

**UNLESS OTHERWISE SET FORTH IN ST'S TERMS AND CONDITIONS OF SALE ST DISCLAIMS ANY EXPRESS OR IMPLIED WARRANTY WITH RESPECT TO THE USE AND/OR SALE OF ST PRODUCTS INCLUDING WITHOUT LIMITATION IMPLIED WARRANTIES OF MERCHANTABILITY, FITNESS FOR A PARTICULAR PURPOSE (AND THEIR EQUIVALENTS UNDER THE LAWS OF ANY JURISDICTION), OR INFRINGEMENT OF ANY PATENT, COPYRIGHT OR OTHER INTELLECTUAL PROPERTY RIGHT.**

**UNLESS EXPRESSLY APPROVED IN WRITING BY AN AUTHORIZED ST REPRESENTATIVE, ST PRODUCTS ARE NOT RECOMMENDED, AUTHORIZED OR WARRANTED FOR USE IN MILITARY, AIR CRAFT, SPACE, LIFE SAVING, OR LIFE SUSTAINING APPLICATIONS, NOR IN PRODUCTS OR SYSTEMS WHERE FAILURE OR MALFUNCTION MAY RESULT IN PERSONAL INJURY, DEATH, OR SEVERE PROPERTY OR ENVIRONMENTAL DAMAGE. ST PRODUCTS WHICH ARE NOT SPECIFIED AS "AUTOMOTIVE GRADE" MAY ONLY BE USED IN AUTOMOTIVE APPLICATIONS AT USER'S OWN RISK.**

Resale of ST products with provisions different from the statements and/or technical features set forth in this document shall immediately void any warranty granted by ST for the ST product or service described herein and shall not create or extend in any manner whatsoever, any liability of ST.

ST and the ST logo are trademarks or registered trademarks of ST in various countries.

Information in this document supersedes and replaces all information previously supplied.

The ST logo is a registered trademark of STMicroelectronics. All other names are the property of their respective owners.

© 2006 STMicroelectronics - All rights reserved

STMicroelectronics group of companies

Australia - Belgium - Brazil - Canada - China - Czech Republic - Finland - France - Germany - Hong Kong - India - Israel - Italy - Japan - Malaysia - Malta - Morocco - Singapore - Spain - Sweden - Switzerland - United Kingdom - United States of America

[www.st.com](http://www.st.com)