



STPS40L45CG/CT/CW

LOW DROP POWER SCHOTTKY RECTIFIER

MAIN PRODUCTS CHARACTERISTICS

$I_{F(AV)}$	2 x 20 A
V_{RRM}	45 V
T_j (max)	150 °C
V_F (max)	0.49 V

FEATURES AND BENEFITS

- LOW FORWARD VOLTAGE DROP MEANING VERY SMALL CONDUCTION LOSSES
- LOW SWITCHING LOSSES ALLOWING HIGH FREQUENCY OPERATION
- AVALANCHE CAPABILITY SPECIFIED

DESCRIPTION

Dual center tap Schottky barrier rectifier designed for high frequency Switched Mode Power Supplies and DC to DC converters.

Packaged in TO-220AB, TO-247 and D²PAK these devices are intended for use in low voltage, high frequency inverters, free-wheeling and polarity protection applications.

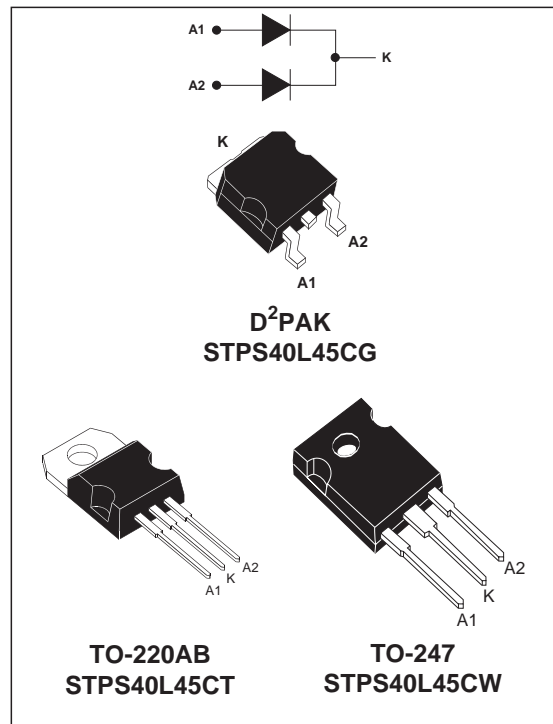

ABSOLUTE RATINGS (limiting values, per diode)

Symbol	Parameter		Value	Unit
V_{RRM}	Repetitive peak reverse voltage		45	V
$I_{F(RMS)}$	RMS forward current		30	A
$I_{F(AV)}$	Average forward current	$T_c = 130^\circ\text{C}$ $\delta = 0.5$	Per diode 40 Per device	A
I_{FSM}	Surge non repetitive forward current	$t_p = 10$ ms Sinusoidal	230	A
I_{RRM}	Repetitive peak reverse current	$t_p = 2$ μs square F = 1kHz	2	A
I_{RSM}	Non repetitive peak reverse current	$t_p = 100$ μs square	3	A
P_{ARM}	Repetitive peak avalanche power	$t_p = 1$ μs $T_j = 25^\circ\text{C}$	8100	W
T_{stg}	Storage temperature range		- 65 to + 150	°C
T_j	Maximum operating junction temperature *		150	°C
dV/dt	Critical rate of rise of reverse voltage		10000	V/ μs

* : $\frac{dP_{tot}}{dT_j} < \frac{1}{R_{th}(j-a)}$ thermal runaway condition for a diode on its own heatsink

STPS40L45CT/CW

THERMAL RESISTANCES

Symbol	Parameter		Value	Unit
$R_{th(j-c)}$	Junction to case	Per diode	1.5	$^{\circ}\text{C}/\text{W}$
		Total	0.8	
$R_{th(c)}$		Coupling	0.1	$^{\circ}\text{C}/\text{W}$

When the diodes 1 and 2 are used simultaneously :

$$\Delta T_{j(\text{diode } 1)} = P(\text{diode } 1) \times R_{th(j-c)}(\text{Per diode}) + P(\text{diode } 2) \times R_{th(c)}$$

STATIC ELECTRICAL CHARACTERISTICS (per diode)

Symbol	Parameter	Tests Conditions		Min.	Typ.	Max.	Unit
I_R^*	Reverse leakage current	$T_j = 25^{\circ}\text{C}$	$V_R = V_{RRM}$			0.6	mA
		$T_j = 125^{\circ}\text{C}$			140	280	
V_F^*	Forward voltage drop	$T_j = 25^{\circ}\text{C}$	$I_F = 20 \text{ A}$			0.53	V
		$T_j = 125^{\circ}\text{C}$			0.42	0.49	
		$T_j = 25^{\circ}\text{C}$	$I_F = 40 \text{ A}$			0.69	
		$T_j = 125^{\circ}\text{C}$			0.6	0.7	

Pulse test : * $t_p = 380 \mu\text{s}$, $\delta < 2\%$

To evaluate the conduction losses use the following equation :

$$P = 0.28 \times I_{F(AV)} + 0.0105 I_{F(RMS)}^2$$

Fig. 1: Average forward power dissipation versus average forward current (per diode).

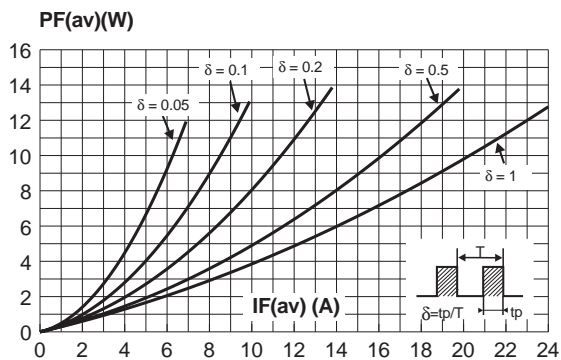

Fig. 2: Average forward current versus ambient temperature ($\delta = 0.5$, per diode)

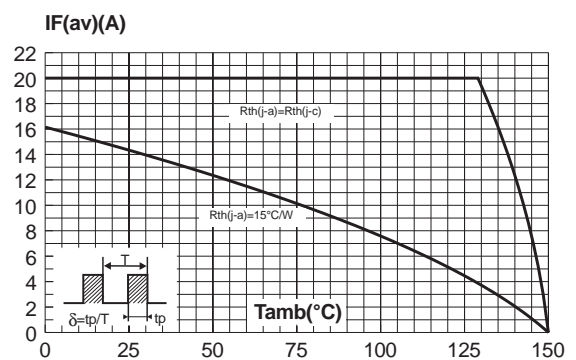

Fig. 3: Normalized avalanche power derating versus pulse duration.

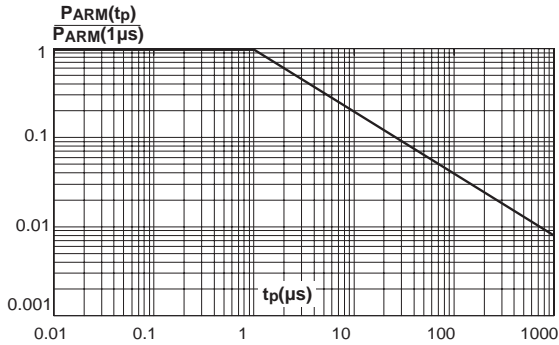

Fig. 4: Normalized avalanche power derating versus junction temperature.

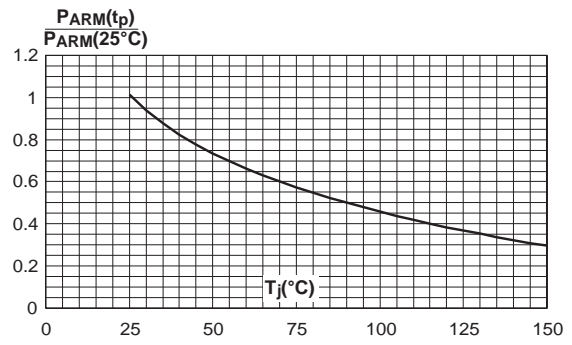

Fig. 5: Non repetitive surge peak forward current versus overload duration (maximum values, per diode).

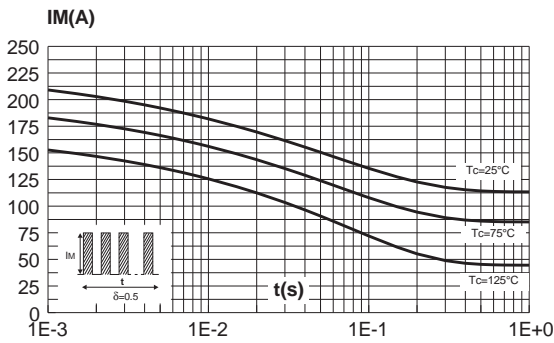

Fig. 6: Relative variation of thermal impedance junction to case versus pulse duration.

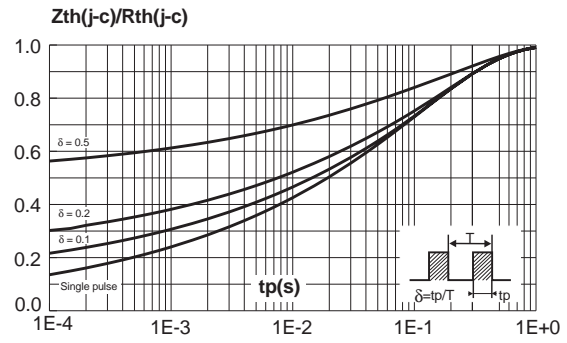

Fig. 7: Reverse leakage current versus reverse voltage applied (typical values, per diode).

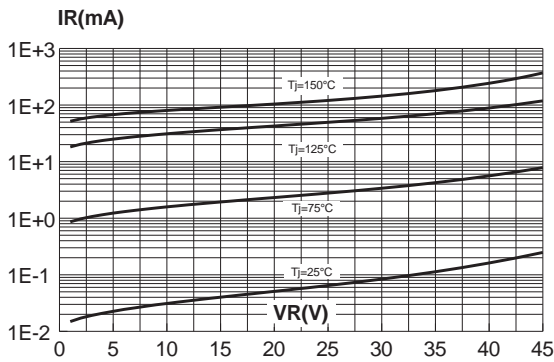
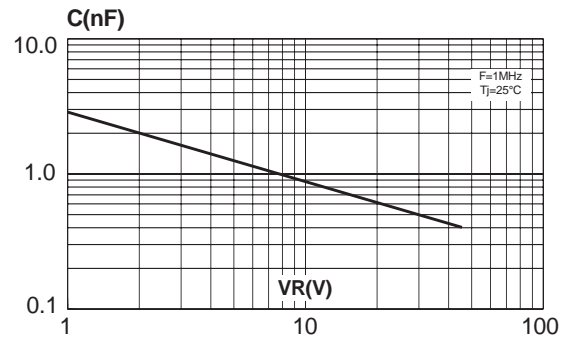

Fig. 8: Junction capacitance versus reverse voltage applied (typical values, per diode).



STPS40L45CT/CW

Fig. 9: Forward voltage drop versus forward current (maximum values, per diode).

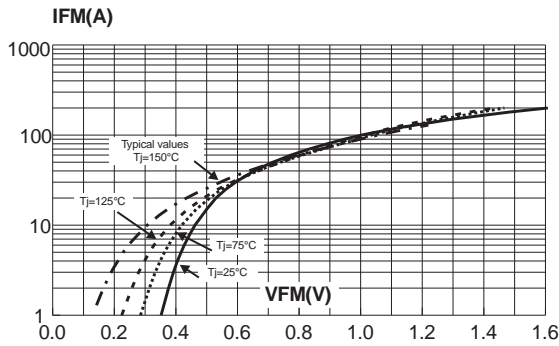
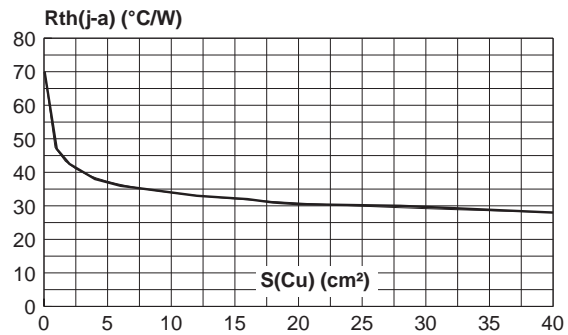
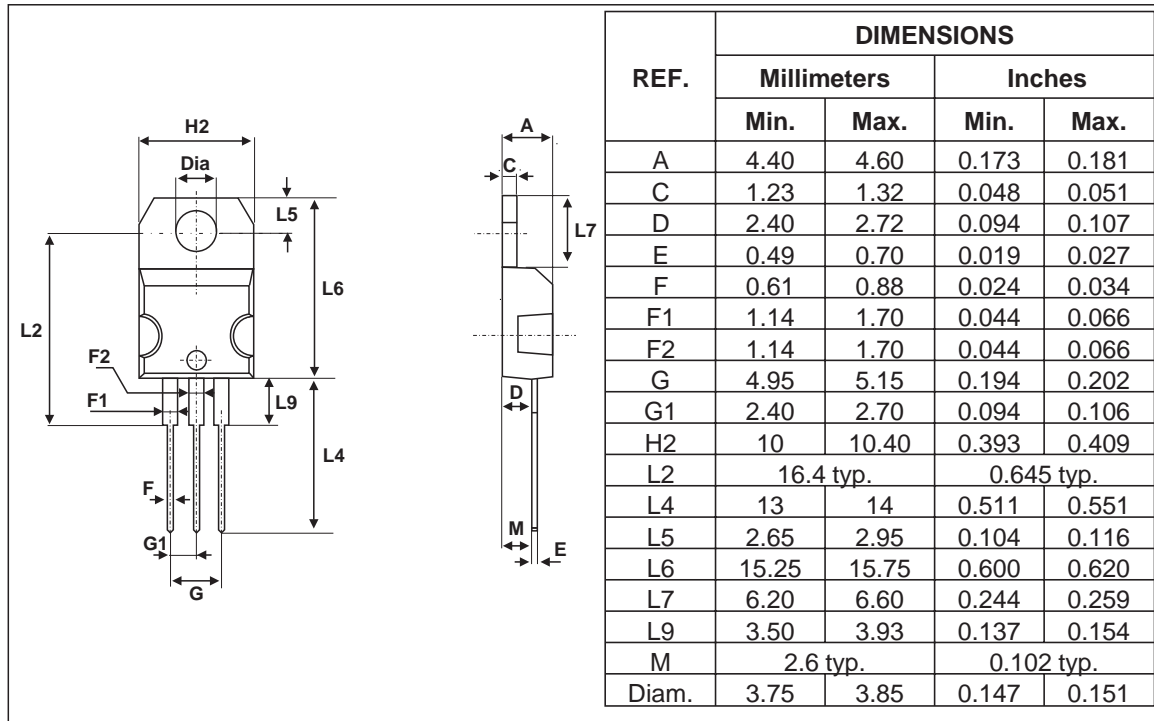

Fig. 10: Thermal resistance junction to ambient versus copper surface under tab (Epoxy printed circuit board FR4, copper thickness: 35µm) (STPS40L45CG only).



PACKAGE MECHANICAL DATA TO-220AB



- COOLING METHOD : C
- RECOMMENDED TORQUE VALUE : 0.55M.N
- MAXIMUM TORQUE VALUE : 0.70 M.N

PACKAGE MECHANICAL DATA
D²PAK

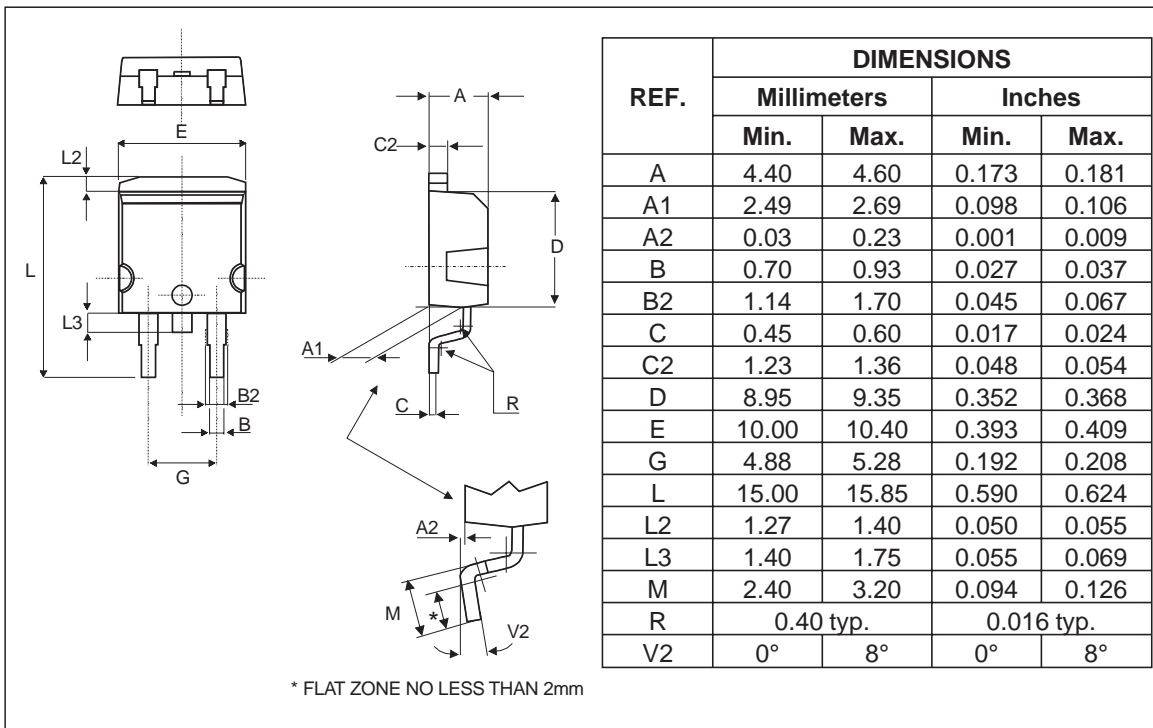

- COOLING METHOD : BY CONDUCTION (METHOD C)

FOOT PRINT (in millimeters)
D²PAK

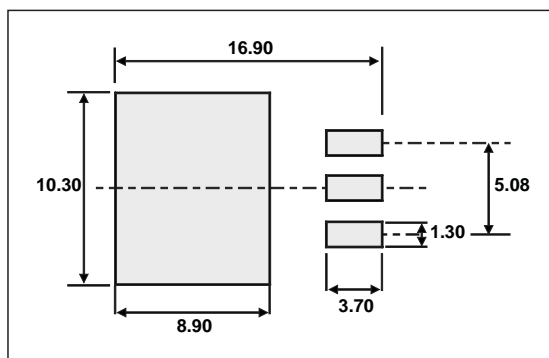

STPS40L45CT/CW

PACKAGE MECHANICAL DATA TO-247

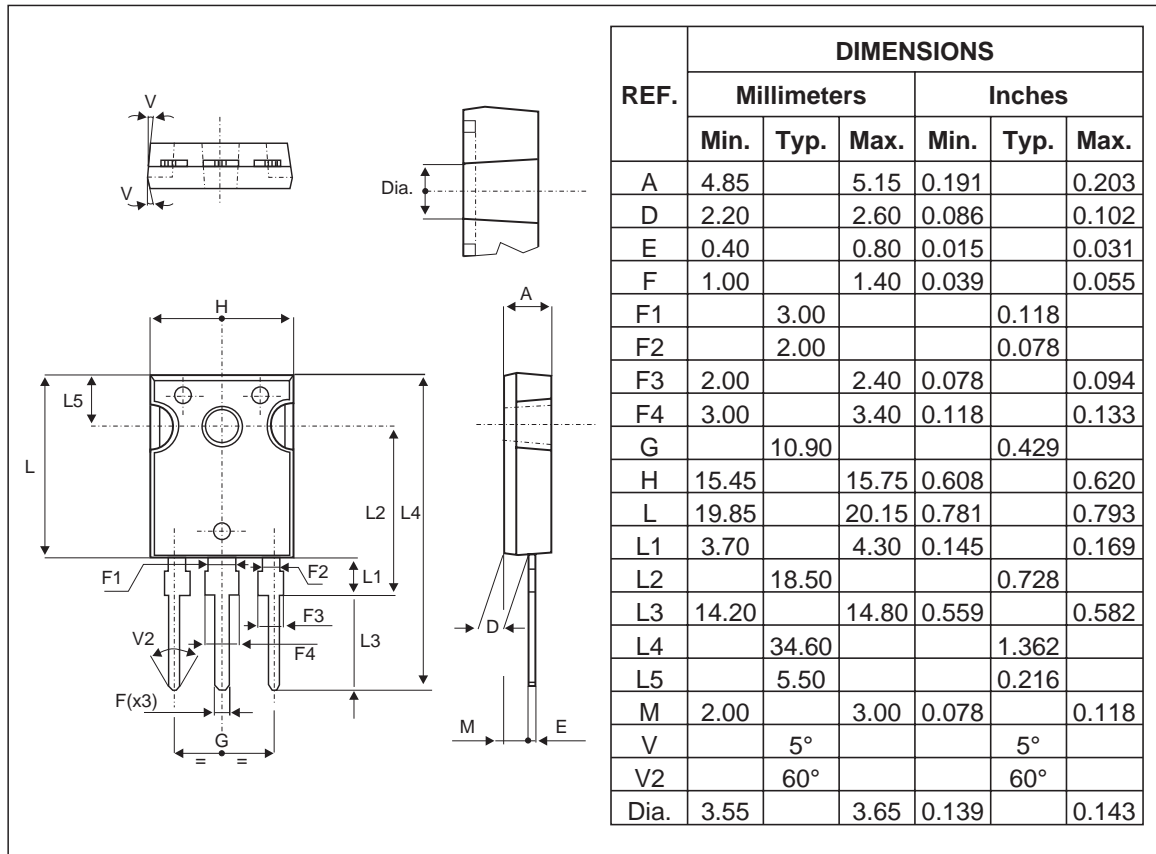

- COOLING METHOD : C
- RECOMMENDED TORQUE VALUE : 0.8M.N
- MAXIMUM TORQUE VALUE : 1.0M.N

Ordering type	Marking	Package	Weight	Base qty	Delivery mode
STPS40L45CG	STPS40L45CG	D2PAK	1.8g	500	Tape & Reel
STPS40L45CT	STPS40L45CT	TO-220AB	2g	50	Tube
STPS40L45CW	STPS40L45CW	TO-247	4.4g	30	Tube

- EPOXY MEETS UL94,V0

Information furnished is believed to be accurate and reliable. However, STMicroelectronics assumes no responsibility for the consequences of use of such information nor for any infringement of patents or other rights of third parties which may result from its use. No license is granted by implication or otherwise under any patent or patent rights of STMicroelectronics. Specifications mentioned in this publication are subject to change without notice. This publication supersedes and replaces all information previously supplied. STMicroelectronics products are not authorized for use as critical components in life support devices or systems without express written approval of STMicroelectronics.

The ST logo is a registered trademark of STMicroelectronics

© 2003 STMicroelectronics - Printed in Italy - All rights reserved.

STMicroelectronics GROUP OF COMPANIES

Australia - Brazil - Canada - China - Finland - France - Germany
 Hong Kong - India - Israel - Italy - Japan - Malaysia - Malta - Morocco - Singapore
 Spain - Sweden - Switzerland - United Kingdom - United States.

<http://www.st.com>