

Main product characteristics

| | |
|--------------|----------|
| $I_{F(AV)}$ | 2 x 10 A |
| V_{RRM} | 120 V |
| $T_{j(max)}$ | 175° C |
| $V_{F(typ)}$ | 0.54 V |

Feature and benefits

- High junction temperature capability
- Avalanche rated
- Low leakage current
- Good trade-off between leakage current and forward voltage drop

Description

Dual center tap Schottky rectifier suited for high frequency switch mode power supply.

Packaged in TO-220AB, I²PAK and TO-220FPAB, this device is intended to be used in notebook and LCD adaptors, desktop SMPS, providing in these applications a margin between the remaining voltages applied on the diode and the voltage capability of the diode.

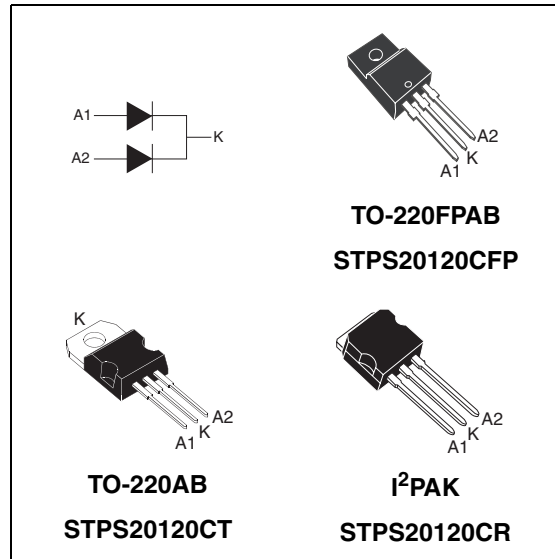

Order code

| Part Number | Marking |
|--------------|--------------|
| STPS20120CT | STPS20120CT |
| STPS20120CR | STPS20120CR |
| STPS20120CFP | STPS20120CFP |

Table 1. Absolute ratings (limiting values, per diode)

| Symbol | Parameter | | Value | Unit | |
|--------------|-------------------------------------------------------|------------------------------|-------------------------------------------------|------|---|
| V_{RRM} | Repetitive peak reverse voltage | | 120 | V | |
| $I_{F(RMS)}$ | RMS forward current | | 30 | A | |
| $I_{F(AV)}$ | Average forward current, $\delta = 0.5$ | TO-220AB, I ² PAK | $T_c = 150^\circ\text{C}$ Per diode | 10 | A |
| | | | $T_c = 145^\circ\text{C}$ Per device | 20 | |
| | | TO-220FPAB | $T_c = 125^\circ\text{C}$ Per diode | 10 | |
| | | | $T_c = 100^\circ\text{C}$ Per device | 20 | |
| I_{FSM} | Surge non repetitive forward current | | $t_p = 10\text{ ms}$ Sinusoidal | 150 | A |
| P_{ARM} | Repetitive peak avalanche power | | $t_p = 1\ \mu\text{s}$ $T_j = 25^\circ\text{C}$ | 4600 | W |
| T_{stg} | Storage temperature range | | -65 to + 175 | ° C | |
| T_j | Maximum operating junction temperature ⁽¹⁾ | | 175 | ° C | |

1. $\frac{dP_{tot}}{dT_j} < \frac{1}{R_{th(j-a)}}$ condition to avoid thermal runaway for a diode on its own heatsink

1 Characteristics

Table 2. Thermal parameters

| Symbol | Parameter | | Value | Unit | |
|---------------|------------------|---------------------|--------------------|------------|-------|
| $R_{th(j-c)}$ | Junction to case | $I^2PAK / TO-220AB$ | Per diode Total | 3 1.8 | ° C/W |
| | | TO-220FPAB | Per diode Total | 5.5 4.5 | |
| $R_{th(c)}$ | Coupling | $I^2PAK / TO-220AB$ | Total | 0.6 | |
| | | TO-220FPAB | | 3.5 | |

When the diodes 1 and 2 are used simultaneously :
 $T_j(\text{diode } 1) = P(\text{diode } 1) \times R_{th(j-c)}(\text{per diode}) + P(\text{diode } 2) \times R_{th(c)}$

Table 3. Static electrical characteristics (per diode)

| Symbol | Test conditions | | Min. | Typ. | Max. | Unit |
|-------------|-------------------------|---------------------|-----------------|------|------|---------|
| $I_R^{(1)}$ | Reverse leakage current | $T_j = 25^\circ C$ | $V_R = V_{RRM}$ | | 10 | μA |
| | | $T_j = 125^\circ C$ | | 1.5 | 5 | mA |
| $V_F^{(2)}$ | Forward voltage drop | $T_j = 25^\circ C$ | $I_F = 2.5 A$ | | 0.7 | V |
| | | $T_j = 125^\circ C$ | | 0.54 | 0.58 | |
| | | $T_j = 25^\circ C$ | $I_F = 10 A$ | | 0.92 | |
| | | $T_j = 125^\circ C$ | | 0.7 | 0.74 | |
| | | $T_j = 25^\circ C$ | $I_F = 20 A$ | | 1.02 | |
| | | $T_j = 125^\circ C$ | | 0.81 | 0.86 | |

1. Pulse test : $t_p = 5 \text{ ms}$, $\delta < 2\%$
2. Pulse test : $t_p = 380 \mu s$, $\delta < 2\%$

To evaluate the maximum conduction losses use the following equation :
 $P = 0.62 \times I_{F(AV)} + 0.012 I_{F(RMS)}^2$

Figure 1. Average forward power dissipation versus average forward current (per diode)

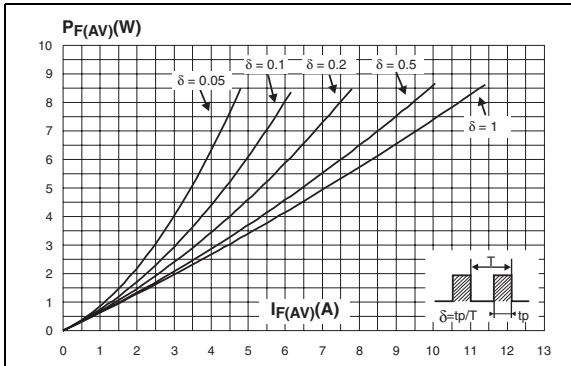

Figure 2. Average forward current versus ambient temperature ($\delta = 0.5$, per diode)

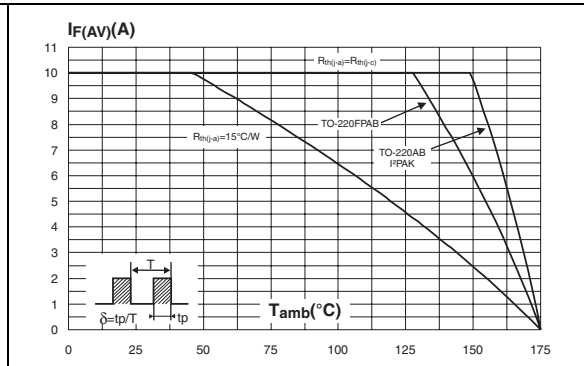

Figure 3. Normalized avalanche power derating versus pulse duration

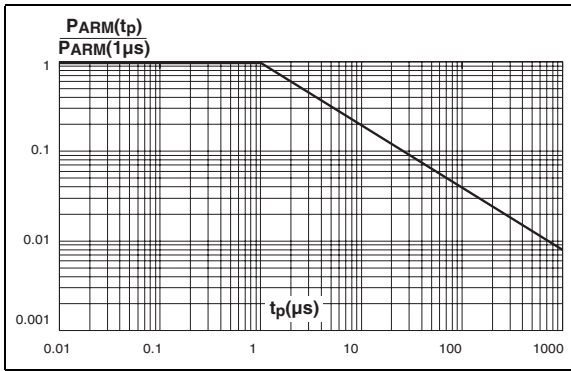

Figure 4. Normalized avalanche power derating versus junction temperature

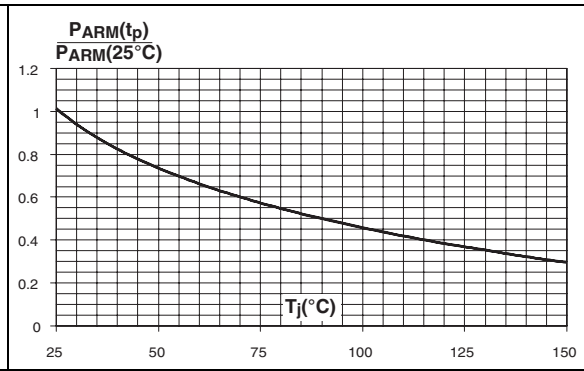

Figure 5. Non repetitive surge peak forward current versus overload duration (maximum values, per diode) (TO-220AB / I²PAK)

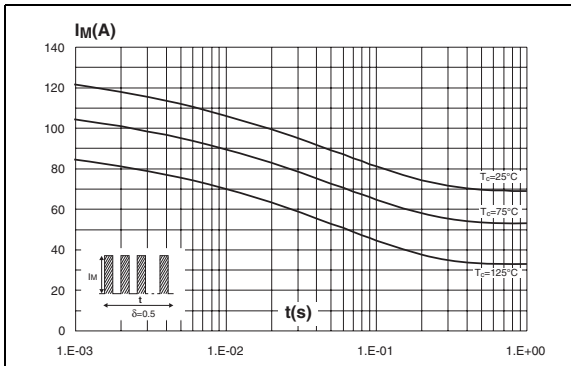

Figure 6. Non repetitive surge peak forward current versus overload duration (maximum values, per diode) (TO-220FPAB)

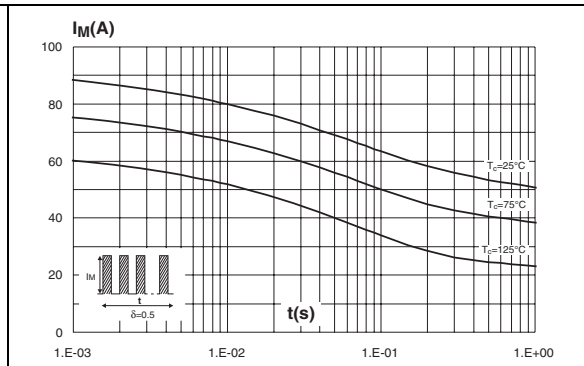

Figure 7. Relative variation of thermal impedance junction to case versus pulse duration (TO-220AB & I²PAK)

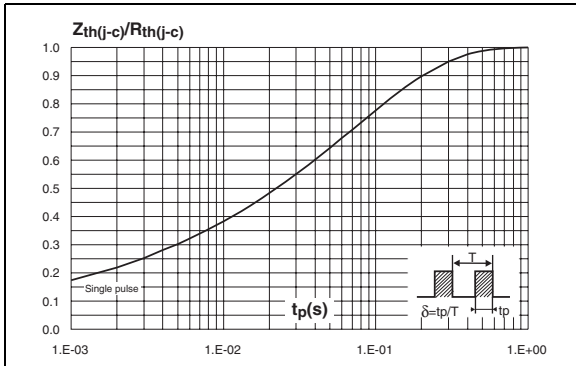

Figure 8. Relative variation of thermal impedance junction to case versus pulse duration (TO-220FPAB)

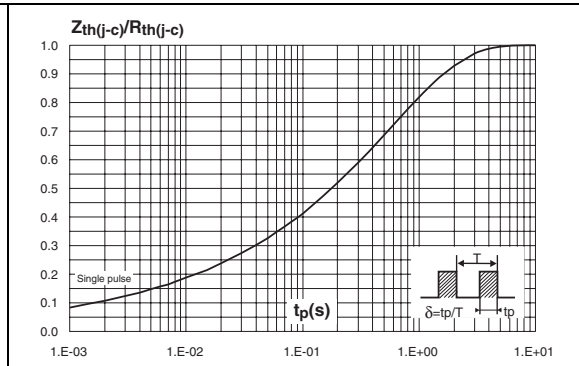

Figure 9. Reverse leakage current versus reverse voltage applied (typical values, per diode)

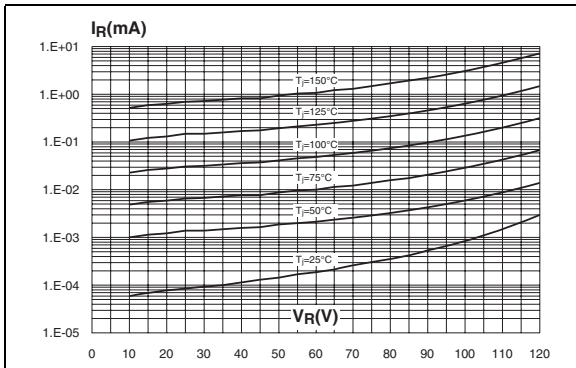

Figure 10. Junction capacitance versus reverse voltage applied (typical values, per diode)

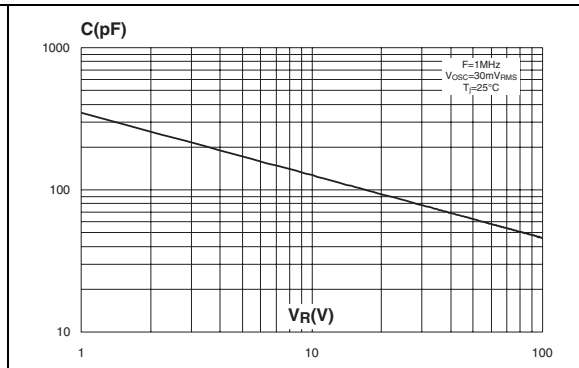
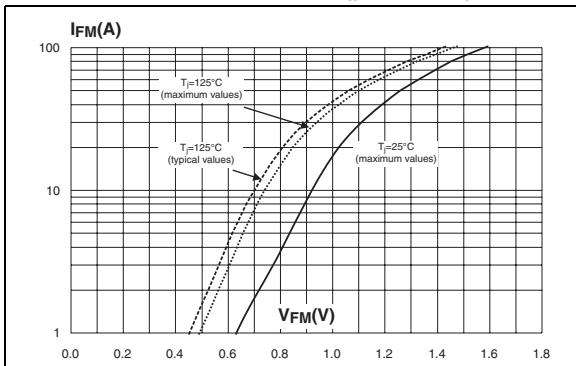

Figure 11. Forward voltage drop versus forward current (per diode)



2 Package information

- Epoxy meets UL94, V0
- Cooling method: by conduction (C)
- Recommended torque value: 0.8 Nm
- Maximum torque value: 1.0 Nm

Table 4. TO-220AB dimensions

| Ref. | Dimensions | | | |
|-------|-------------|-------|------------|-------|
| | Millimeters | | Inches | |
| | Min. | Max. | Min. | Max. |
| A | 4.40 | 4.60 | 0.173 | 0.181 |
| C | 1.23 | 1.32 | 0.048 | 0.051 |
| D | 2.40 | 2.72 | 0.094 | 0.107 |
| E | 0.49 | 0.70 | 0.019 | 0.027 |
| F | 0.61 | 0.88 | 0.024 | 0.034 |
| F1 | 1.14 | 1.70 | 0.044 | 0.066 |
| F2 | 1.14 | 1.70 | 0.044 | 0.066 |
| G | 4.95 | 5.15 | 0.194 | 0.202 |
| G1 | 2.40 | 2.70 | 0.094 | 0.106 |
| H2 | 10 | 10.40 | 0.393 | 0.409 |
| L2 | 16.4 typ. | | 0.645 typ. | |
| L4 | 13 | 14 | 0.511 | 0.551 |
| L5 | 2.65 | 2.95 | 0.104 | 0.116 |
| L6 | 15.25 | 15.75 | 0.600 | 0.620 |
| L7 | 6.20 | 6.60 | 0.244 | 0.259 |
| L9 | 3.50 | 3.93 | 0.137 | 0.154 |
| M | 2.6 typ. | | 0.102 typ. | |
| Diam. | 3.75 | 3.85 | 0.147 | 0.151 |

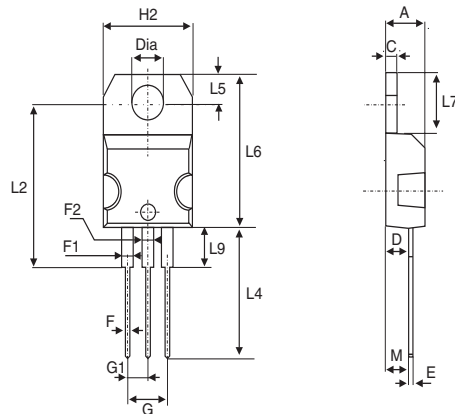

Table 5. I²PAK dimensions

| Ref. | Dimensions | | | |
|------|-------------|------|--------|-------|
| | Millimeters | | Inches | |
| | Min. | Max. | Min. | Max. |
| A | 4.40 | 4.60 | 0.173 | 0.181 |
| A1 | 2.49 | 2.69 | 0.098 | 0.106 |
| b | 0.70 | 0.93 | 0.028 | 0.037 |
| b1 | 1.14 | 1.70 | 0.044 | 0.067 |
| b2 | 1.14 | 1.70 | 0.044 | 0.067 |
| c | 0.45 | 0.60 | 0.018 | 0.024 |
| c2 | 1.23 | 1.36 | 0.048 | 0.054 |
| D | 8.95 | 9.35 | 0.352 | 0.368 |
| e | 2.40 | 2.70 | 0.094 | 0.106 |
| E | 10.0 | 10.4 | 0.394 | 0.409 |
| L | 13.1 | 13.6 | 0.516 | 0.535 |
| L1 | 3.48 | 3.78 | 0.137 | 0.149 |
| L2 | 1.27 | 1.40 | 0.050 | 0.055 |

Table 6. TO-220FPAB dimensions

| Ref. | Dimensions | | | |
|------|-------------|------|-----------|-------|
| | Millimeters | | Inches | |
| | Min. | Max. | Min. | Max. |
| A | 4.4 | 4.6 | 0.173 | 0.181 |
| B | 2.5 | 2.7 | 0.098 | 0.106 |
| D | 2.5 | 2.75 | 0.098 | 0.108 |
| E | 0.45 | 0.70 | 0.018 | 0.027 |
| F | 0.75 | 1 | 0.030 | 0.039 |
| F1 | 1.15 | 1.70 | 0.045 | 0.067 |
| F2 | 1.15 | 1.70 | 0.045 | 0.067 |
| G | 4.95 | 5.20 | 0.195 | 0.205 |
| G1 | 2.4 | 2.7 | 0.094 | 0.106 |
| H | 10 | 10.4 | 0.393 | 0.409 |
| L2 | 16 Typ. | | 0.63 Typ. | |
| L3 | 28.6 | 30.6 | 1.126 | 1.205 |
| L4 | 9.8 | 10.6 | 0.386 | 0.417 |
| L5 | 2.9 | 3.6 | 0.114 | 0.142 |
| L6 | 15.9 | 16.4 | 0.626 | 0.646 |
| L7 | 9.00 | 9.30 | 0.354 | 0.366 |
| Dia. | 3.00 | 3.20 | 0.118 | 0.126 |

In order to meet environmental requirements, ST offers these devices in ECOPACK® packages. These packages have a lead-free second level interconnect. The category of second level interconnect is marked on the package and on the inner box label, in compliance with JEDEC Standard JESD97. The maximum ratings related to soldering conditions are also marked on the inner box label. ECOPACK is an ST trademark. ECOPACK specifications are available at: www.st.com.

3 Ordering information

| Ordering type | Marking | Package | Weight | Base qty | Delivery mode |
|---------------|--------------|--------------------|--------|----------|---------------|
| STPS20120CT | STPS20120CT | TO-220AB | 2.23 g | 50 | Tube |
| STPS20120CR | STPS20120CR | I ² PAK | 1.49 g | 50 | Tube |
| STPS20120CFP | STPS20120CFP | TO-220FPAB | 2.0 g | 50 | Tube |

4 Revision history

| Date | Revision | Description of Changes |
|-------------|----------|-------------------------------------------------------------|
| 18-Feb-2005 | 1 | First issue |
| 03-May-2007 | 2 | Reformatted to current standards. Added TO-220FPAB package. |

Please Read Carefully:

Information in this document is provided solely in connection with ST products. STMicroelectronics NV and its subsidiaries ("ST") reserve the right to make changes, corrections, modifications or improvements, to this document, and the products and services described herein at any time, without notice.

All ST products are sold pursuant to ST's terms and conditions of sale.

Purchasers are solely responsible for the choice, selection and use of the ST products and services described herein, and ST assumes no liability whatsoever relating to the choice, selection or use of the ST products and services described herein.

No license, express or implied, by estoppel or otherwise, to any intellectual property rights is granted under this document. If any part of this document refers to any third party products or services it shall not be deemed a license grant by ST for the use of such third party products or services, or any intellectual property contained therein or considered as a warranty covering the use in any manner whatsoever of such third party products or services or any intellectual property contained therein.

UNLESS OTHERWISE SET FORTH IN ST'S TERMS AND CONDITIONS OF SALE ST DISCLAIMS ANY EXPRESS OR IMPLIED WARRANTY WITH RESPECT TO THE USE AND/OR SALE OF ST PRODUCTS INCLUDING WITHOUT LIMITATION IMPLIED WARRANTIES OF MERCHANTABILITY, FITNESS FOR A PARTICULAR PURPOSE (AND THEIR EQUIVALENTS UNDER THE LAWS OF ANY JURISDICTION), OR INFRINGEMENT OF ANY PATENT, COPYRIGHT OR OTHER INTELLECTUAL PROPERTY RIGHT.

UNLESS EXPRESSLY APPROVED IN WRITING BY AN AUTHORIZED ST REPRESENTATIVE, ST PRODUCTS ARE NOT RECOMMENDED, AUTHORIZED OR WARRANTED FOR USE IN MILITARY, AIR CRAFT, SPACE, LIFE SAVING, OR LIFE SUSTAINING APPLICATIONS, NOR IN PRODUCTS OR SYSTEMS WHERE FAILURE OR MALFUNCTION MAY RESULT IN PERSONAL INJURY, DEATH, OR SEVERE PROPERTY OR ENVIRONMENTAL DAMAGE. ST PRODUCTS WHICH ARE NOT SPECIFIED AS "AUTOMOTIVE GRADE" MAY ONLY BE USED IN AUTOMOTIVE APPLICATIONS AT USER'S OWN RISK.

Resale of ST products with provisions different from the statements and/or technical features set forth in this document shall immediately void any warranty granted by ST for the ST product or service described herein and shall not create or extend in any manner whatsoever, any liability of ST.

ST and the ST logo are trademarks or registered trademarks of ST in various countries.

Information in this document supersedes and replaces all information previously supplied.

The ST logo is a registered trademark of STMicroelectronics. All other names are the property of their respective owners.

© 2007 STMicroelectronics - All rights reserved

STMicroelectronics group of companies

Australia - Belgium - Brazil - Canada - China - Czech Republic - Finland - France - Germany - Hong Kong - India - Israel - Italy - Japan - Malaysia - Malta - Morocco - Singapore - Spain - Sweden - Switzerland - United Kingdom - United States of America

www.st.com

