



# STPS16150CT/CG/CR

## HIGH VOLTAGE POWER SCHOTTKY RECTIFIER

### MAIN PRODUCT CHARACTERISTICS

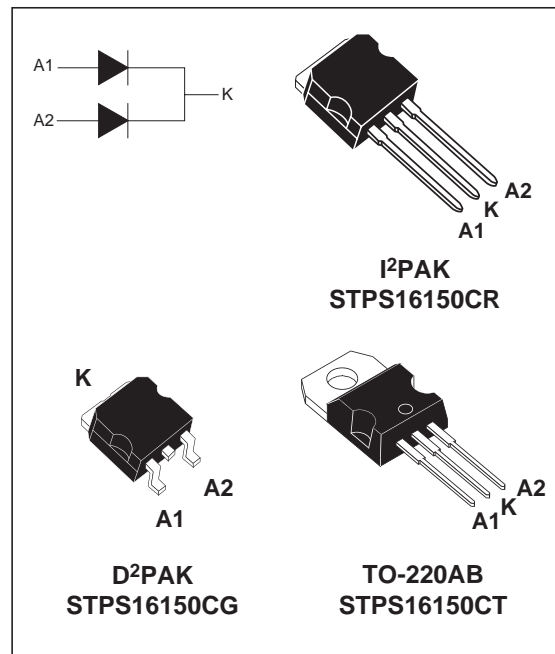
$I_{F(AV)}$	<b>2 x 8 A</b>
$V_{RRM}$	<b>150 V</b>
$T_j$	<b>175°C</b>
$V_F$ (max)	<b>0.75 V</b>

### FEATURES AND BENEFITS

- HIGH JUNCTION TEMPERATURE CAPABILITY
- GOOD TRADE OFF BETWEEN LEAKAGE CURRENT AND FORWARD VOLTAGE DROP
- LOW LEAKAGE CURRENT
- AVALANCHE CAPABILITY SPECIFIED

### DESCRIPTION

Dual center tap schottky rectifier designed for high frequency Switched Mode Power Supplies.



### ABSOLUTE RATINGS (limiting values, per diode)

Symbol	Parameter			Value	Unit
$V_{RRM}$	Repetitive peak reverse voltage			150	V
$I_{F(RMS)}$	RMS forward current			20	A
$I_{F(AV)}$	Average forward current $\delta = 0.5$	TO-220AB D <sup>2</sup> PAK / I <sup>2</sup> PAK	$T_c = 150^\circ\text{C}$ per diode per device	8 16	A
$I_{FSM}$	Surge non repetitive forward current		$t_p = 10 \text{ ms}$ sinusoidal	150	A
$P_{ARM}$	Repetitive peak avalanche power		$t_p = 1 \mu\text{s}$ $T_j = 25^\circ\text{C}$	4700	W
$T_{stg}$	Storage temperature range			- 65 to + 175	°C
$T_j$	Maximum operating junction temperature			175	°C
dV/dt	Critical rate of rise of reverse voltage			10000	V/ $\mu\text{s}$

# STPS16150CT/CG/CR

## THERMAL RESISTANCES

Symbol	Parameter		Value	Unit	
$R_{th(j-c)}$	Junction to case	TO-220AB / D <sup>2</sup> PAK / I <sup>2</sup> PAK	Per diode	3	°C/W
			Total	1.8	
$R_{th(c)}$		TO-220AB / D <sup>2</sup> PAK / I <sup>2</sup> PAK	Coupling	0.6	

When the diodes 1 and 2 are used simultaneously :  
 $\Delta T_j(\text{diode 1}) = P(\text{diode 1}) \times R_{th(j-c)}(\text{Per diode}) + P(\text{diode 2}) \times R_{th(c)}$

## STATIC ELECTRICAL CHARACTERISTICS (per diode)

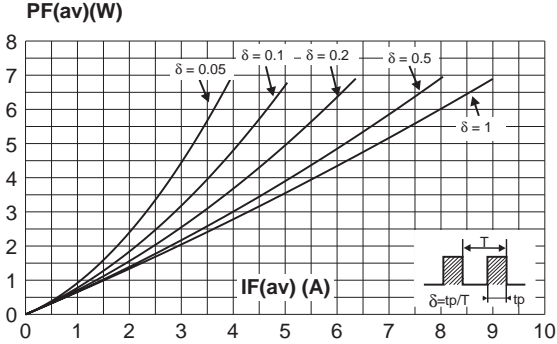
Symbol	Parameter	Tests conditions		Min.	Typ.	Max.	Unit
$I_R^*$	Reverse leakage current	$T_j = 25^\circ\text{C}$	$V_R = V_{RRM}$			3.0	$\mu\text{A}$
		$T_j = 125^\circ\text{C}$				4.0	mA
$V_F^{**}$	Forward voltage drop	$T_j = 25^\circ\text{C}$	$I_F = 8\text{ A}$			0.92	V
		$T_j = 125^\circ\text{C}$	$I_F = 8\text{ A}$		0.70	0.75	
		$T_j = 25^\circ\text{C}$	$I_F = 16\text{ A}$			1	
		$T_j = 125^\circ\text{C}$	$I_F = 16\text{ A}$		0.8	0.86	

Pulse test : \*  $t_p = 5\text{ ms}$ ,  $\delta < 2\%$   
 \*\*  $t_p = 380\text{ }\mu\text{s}$ ,  $\delta < 2\%$

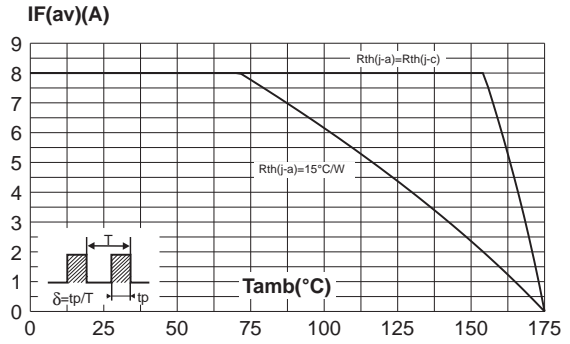
To evaluate the conduction losses use the following equation:  
 $P = 0.64 \times I_{F(AV)} + 0.014 I_{F(RMS)}^2$

**Fig. 1:** Average forward power dissipation versus average forward current (per diode).

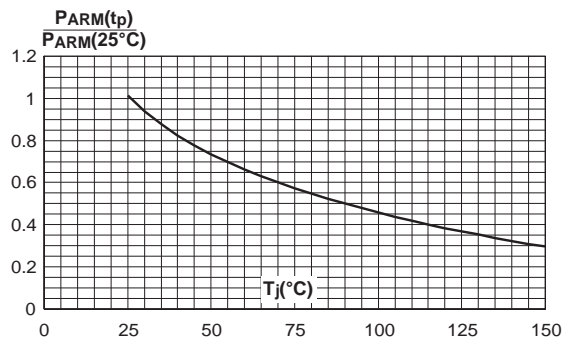
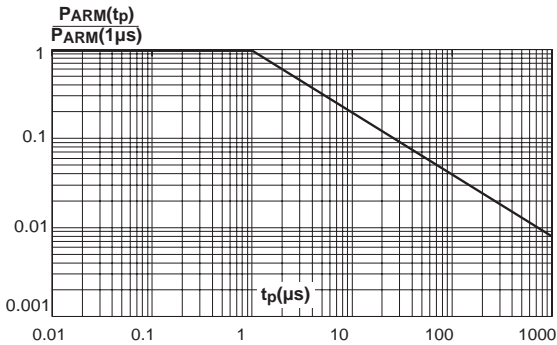
**Fig. 2:** Average forward current versus ambient temperature ( $\delta = 0.5$ , per diode).



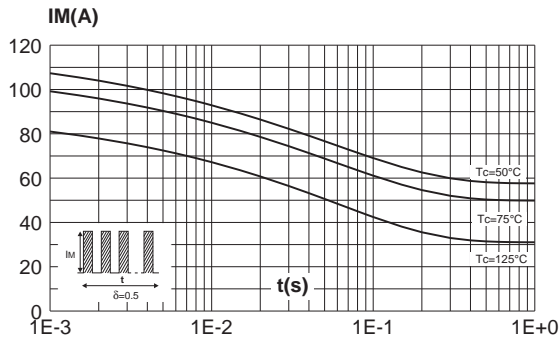
**Fig. 3:** Normalized avalanche power derating versus pulse duration.



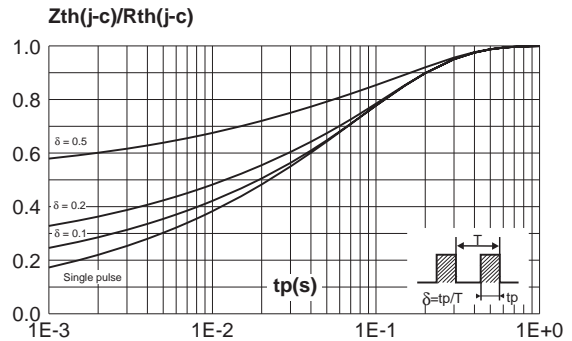
**Fig. 4:** Normalized avalanche power derating versus junction temperature.



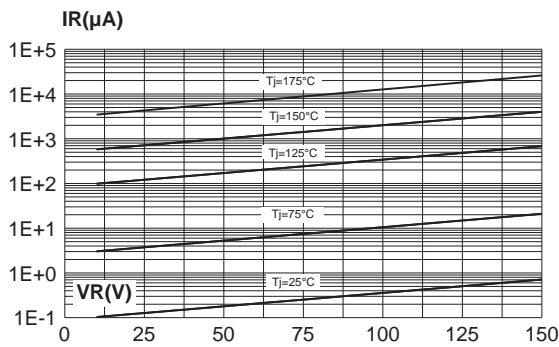
**Fig. 5:** Non repetitive surge peak forward current versus overload duration (maximum values, per diode).



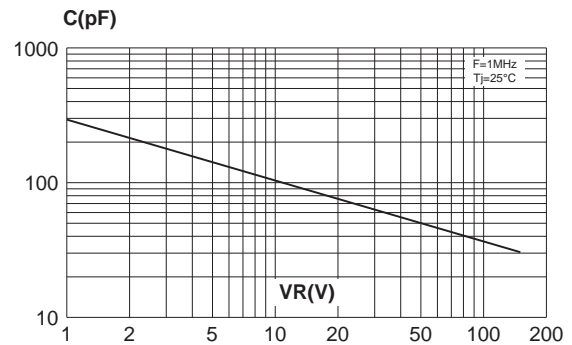
**Fig. 46** Relative variation of thermal impedance junction to case versus pulse duration (per diode).



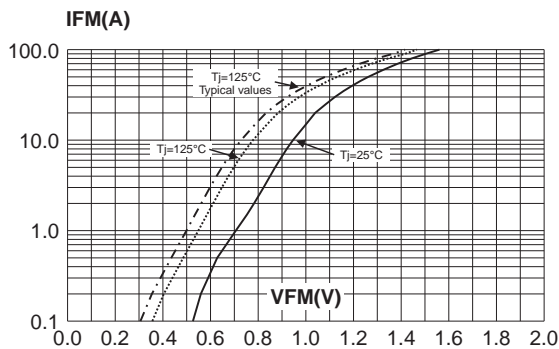
**Fig. 7:** Reverse leakage current versus reverse voltage applied (typical values, per diode).



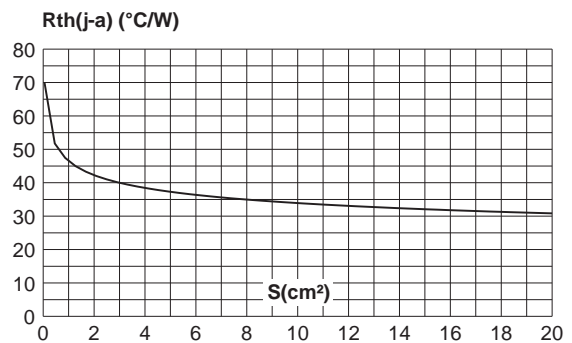
**Fig. 8:** Junction capacitance versus reverse voltage applied (typical values, per diode).



**Fig. 9:** Forward voltage drop versus forward current (maximum values, per diode).

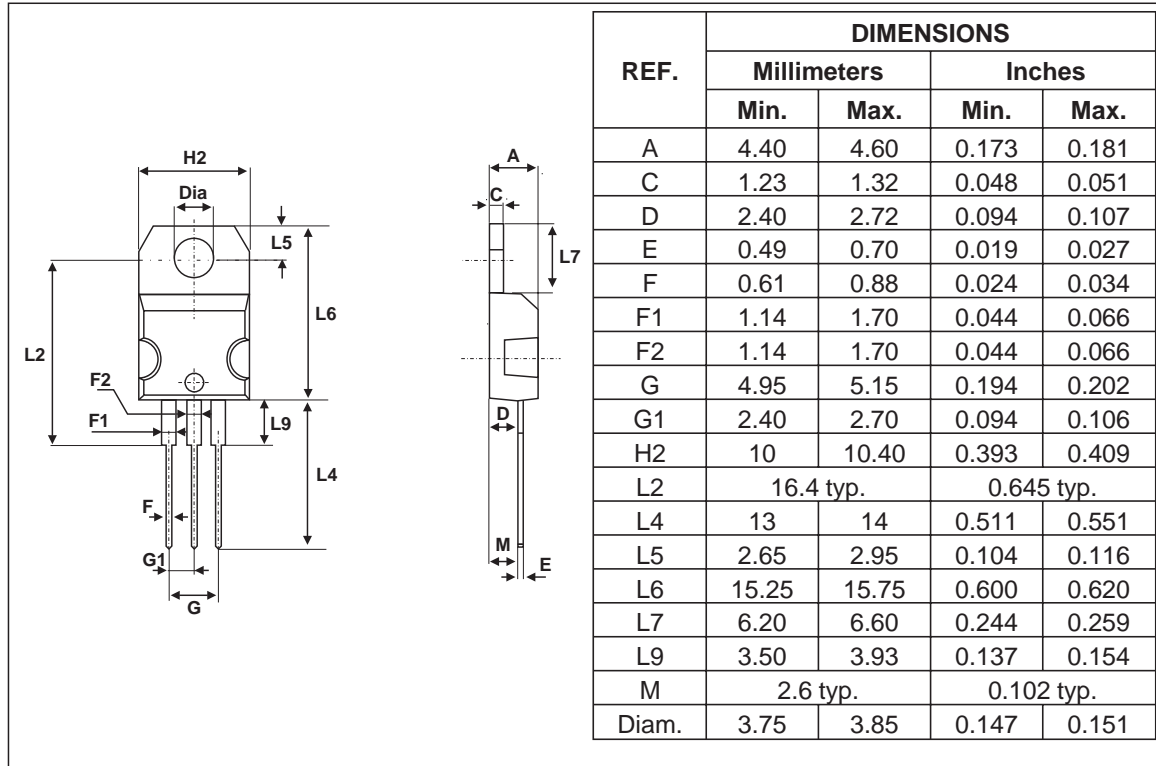


**Fig. 10:** Thermal resistance junction to ambient versus copper surface under tab (Epoxy printed circuit board, copper thickness: 35 $\mu\text{m}$ ) (STPS16150CG only).

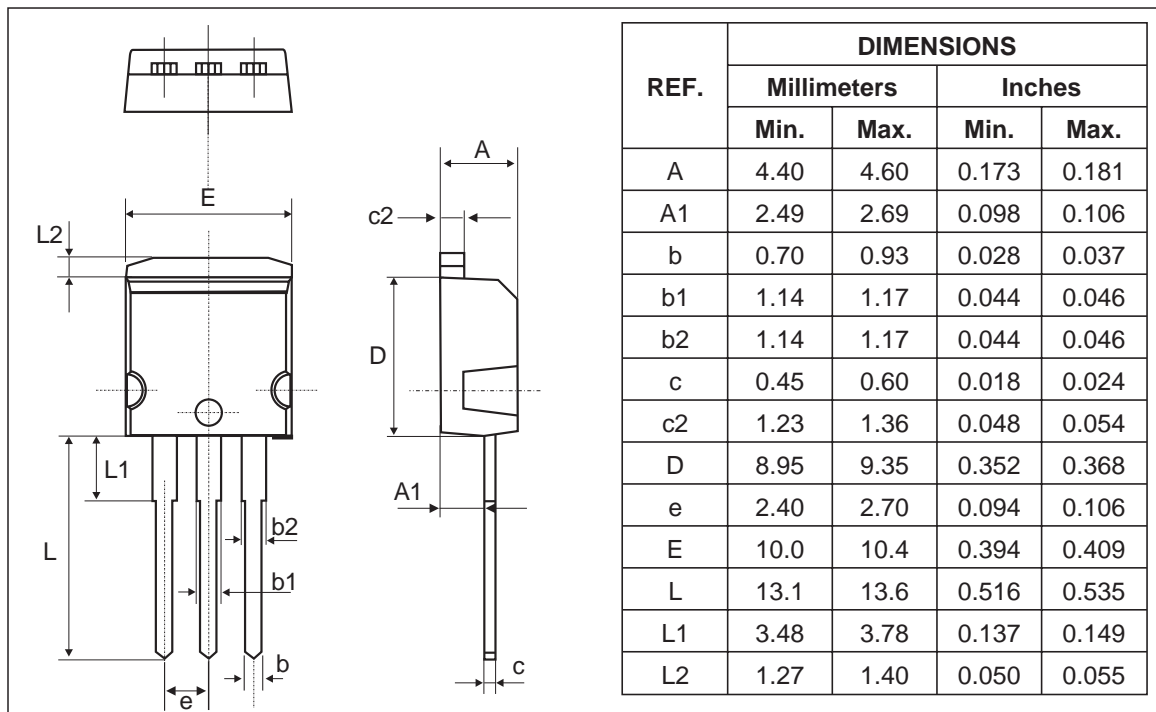


# STPS16150CT/CG/CR

## PACKAGE MECHANICAL DATA TO-220AB

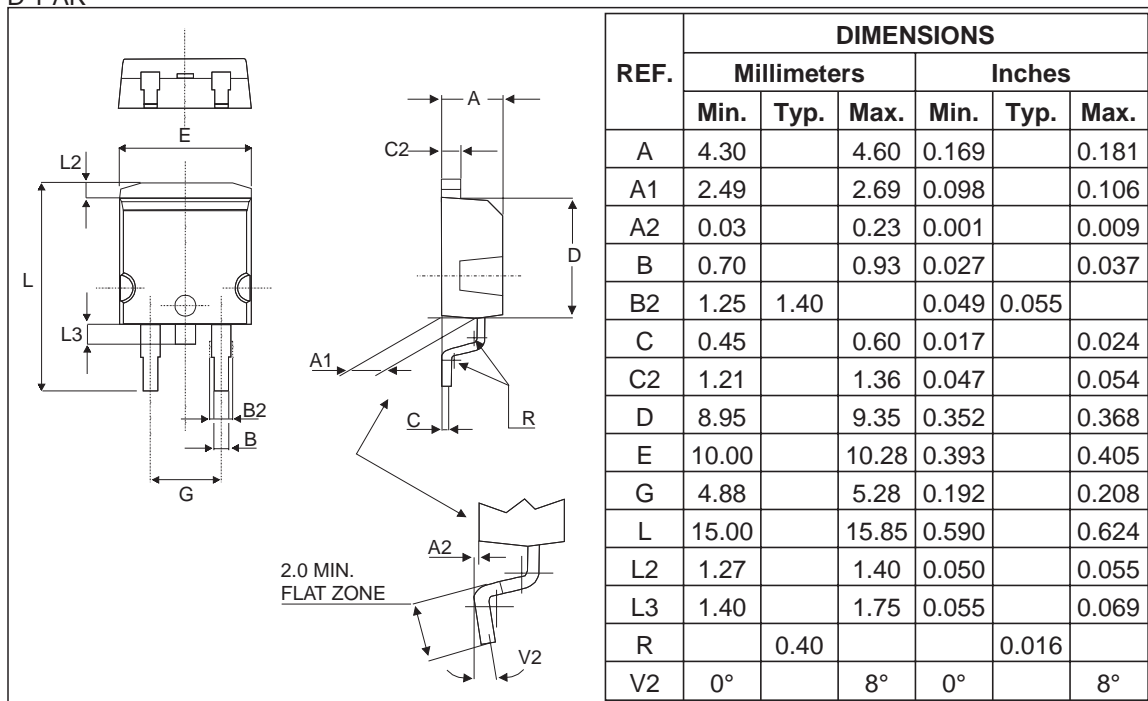


## PACKAGE MECHANICAL DATA I<sup>2</sup>PAK

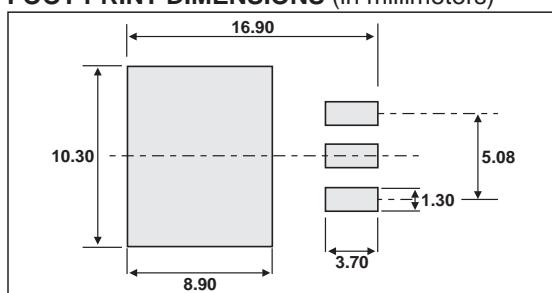


**PACKAGE MECHANICAL DATA**

D<sup>2</sup>PAK



**FOOT PRINT DIMENSIONS (in millimeters)**



Ordering type	Marking	Package	Weight	Base qty	Delivery mode
STPS16150CT	STPS16150CT	TO-220AB	2.2 g	50	Tube
STPS16150CG	STPS16150CG	D <sup>2</sup> PAK	1.48 g	50	Tube
STPS16150CG-TR	STPS16150CG	D <sup>2</sup> PAK	1.48 g	1000	Tape & reel
STPS16150CR	STPS16150CR	I <sup>2</sup> PAK	1.49 g	50	Tube

- Epoxy meets UL94, V0

Information furnished is believed to be accurate and reliable. However, STMicroelectronics assumes no responsibility for the consequences of use of such information nor for any infringement of patents or other rights of third parties which may result from its use. No license is granted by implication or otherwise under any patent or patent rights of STMicroelectronics. Specifications mentioned in this publication are subject to change without notice. This publication supersedes and replaces all information previously supplied. STMicroelectronics products are not authorized for use as critical components in life support devices or systems without express written approval of STMicroelectronics.

The ST logo is a registered trademark of STMicroelectronics

© 2003 STMicroelectronics - Printed in Italy - All rights reserved.

STMicroelectronics GROUP OF COMPANIES

Australia - Brazil - Canada - China - Finland - France - Germany  
 Hong Kong - India - Israel - Italy - Japan - Malaysia - Malta - Morocco - Singapore  
 Spain - Sweden - Switzerland - United Kingdom - United States.



<http://www.st.com>