

DATE DRAWING TO BE SUPERSEDED BY THIS ELECTRONICS CORPORATION, ALL RIGHTS RESERVED

REV	DATE	DESCRIPTION	BY	CHK	APPV
1		PRELIMINARY PER EC 0860-0218-04	SHAWKIN	BOV	SSA
0		RELEASED PER EC 0860-2502-04	SHAWKIN	BLD	SSA
A		REVISED PER ECR-08-2503-04	SHAWKIN	AN	SA

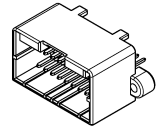

SCALE 2:1

- △ TO BE MEASURED WITHIN 2mm FROM \square
- 2. APPLICABLE P.C. BOARD THICKNESS: 1.6mm.
- 3. MATING PLUG HOUSING PART NUMBER: 174047.
- 4. RECOMMENDED MOUNTING SCREW: 3mm DIA, 6mm LENGTH TAPPING SCREW SPECIFIED IN JIS B115, B1122 (TIGHTENING TORQUE: 0.8Nm MAX).
- 5. SIMILAR TO 174977.
- △ BASIC DIMENSIONS ESTABLISHED BY CUSTOMER.

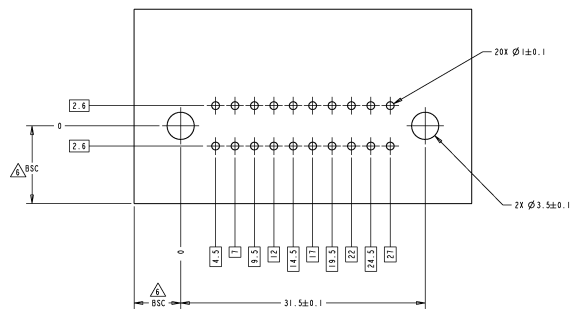
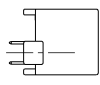
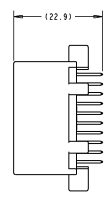
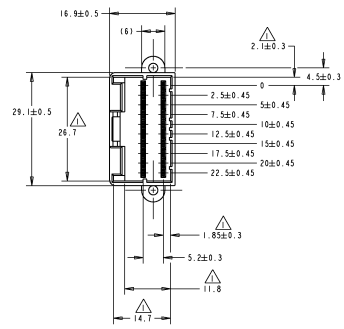
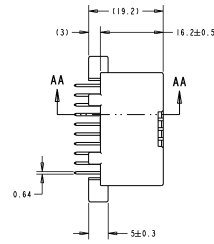
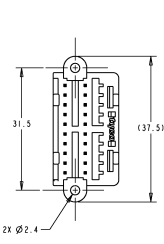

P.C. BOARD LAYOUT
RECOMMENDED THICKNESS: 1.6mm
TOLERANCE: ±0.1
SCALE 4:1

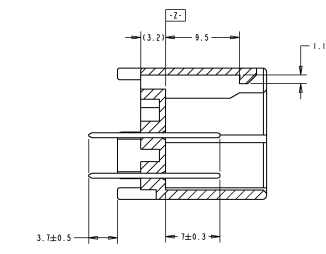

SECTION AA-AA
SCALE 4:1

SINGLE TUBE	BRASS	PRE-TINNED	PBT	BLACK	1438720-3
	BRASS	POST-TINNED	PBT	BLACK	2-1438720-2
MULTI-TUBE	BRASS	PRE-TINNED	PBT	GREEN	1438720-4
	BRASS	PRE-TINNED	PBT	BLACK	1438720-2
MATERIAL		FINISH	MATERIAL	COLOR	
CONTACT		HOUSING		PART NUMBER	

DESCRIPTION	QTY	UNIT	REVISION	DATE	BY	CHK	APPV
20 POSITION VERTICAL MULTILOCK I/O CONNECTOR	1	PCB	001	08/25/04	SHAWKIN	BOV	SSA
WEIGHT	5.9g						
SEE TABLE	SEE TABLE	CUSTOMER DRAWING	SCALE	2:1	SHEET	1	OF 1