

THIS DRAWING IS UNPUBLISHED
 ALL RIGHTS RESERVED

REV	DATE	DESCRIPTION	BY	CHKD
00				
AP3		REVISED PER EDR-11-620221		

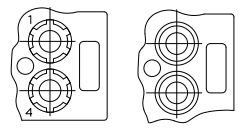

DETAIL A
 OPTIONAL CONSTRUCTIONS

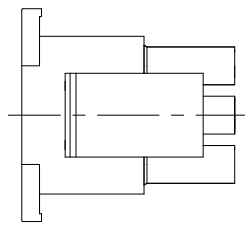
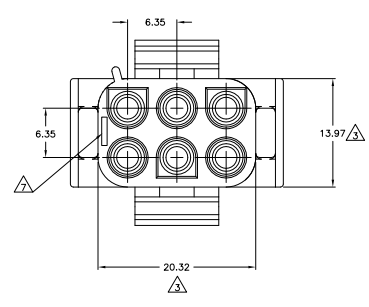
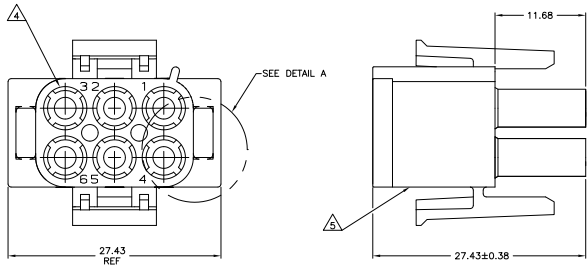
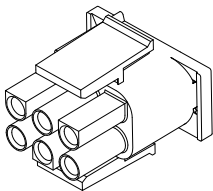

3-DIMENSIONAL MODEL
 NTS

MM	IN
27.43	1.080
20.32	.800
13.97	.550
11.68	.460
0.38	.015
0.13	.005

CONVERSION TABLE
 999 9999

- MATES WITH APPROPRIATE UNIVERSAL MATE-N-LOK® CAP OR HEADER.
 - SMALL NICKS ARE PERMITTED ON THE CIRCUIT TOWERS WHICH COULD INCREASE THE INITIAL HOUSING MATING FORCE BY UP TO 4.4 NEWTONS [1.0 LBS]. NO INDIVIDUAL NICKED TOWER SHALL INCREASE THIS FORCE BY OVER 2.2 NEWTONS [.5 LBS].
- △ DIMENSION INDICATED IS AS MOLDED. ADDITIONAL GROWTH DUE TO SUBSEQUENT MOISTURE ABSORPTION MAY OCCUR.
- △ FOUR RIBS EQUALLY SPACED, NO SPECIFIC ORIENTATION, NO RIBS OR SIX RIBS EQUALLY SPACED, NO SPECIFIC ORIENTATION, OPTIONAL.
- △ UNDERWRITERS RECOGNIZED COMPONENT LOGO AND CSA CERTIFICATION LOGO TO BE LOCATED ONCE EACH ON SIDE OF HOUSING.
6. MANUFACTURING LOCATION ID ON SIDE OF HOUSING (OPTIONAL).
- △ TRADEMARK LOCATION (AMP OR TE CONNECTIVITY).
- △ OBSOLETE PARTS: OBSOLETE CIS STREAMLINING PER D.RENAUD/D.SINISI

OBsolete	COLOR	PART NUMBER
△ OBSOLETE	BLACK	1-480704-9
△ SUPERSEDED BY 1-480704-0	GRAY	1-480704-8
△ OBSOLETE	BLUE	1-480704-6
△ OBSOLETE	GREEN	1-480704-5
	YELLOW	1-480704-4
△ OBSOLETE	ORANGE	1-480704-3
	RED	1-480704-2
	BROWN	1-480704-1
	NATURAL	1-480704-0
	COLOR	PART NUMBER

THIS DRAWING IS A CONTROLLED DOCUMENT.

AP3	100779	480704	4.1	1	2	AP3
-----	--------	--------	-----	---	---	-----

TE Connectivity
 PLUG, 8 CIRCUIT, UNIVERSAL MATE-N-LOK(TM)
 CUSTOMER DRAWING



THIS DRAWING IS UNPUBLISHED
 ALL RIGHTS RESERVED

REV	DATE	DESCRIPTION	BY	APP
CM	00	SEE SHEET 1	-	-

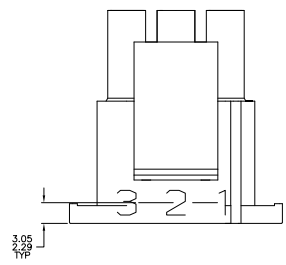

1. STAMP NUMBERS 3.18 HIGH AT WIRE END OF HOUSING (12 POINT DAVID TYPE).
2. CHARACTERS TO BE POSITIONED ON HOUSING TO BE READ FROM WIRE END ONLY.
3. VIOLET, BLACK, BROWN, AND BLUE COLORED BLOCKS TO BE STAMPED WITH WHITE CHARACTERS. ALL OTHER COLORED BLOCKS TO BE STAMPED WITH BLACK CHARACTERS.

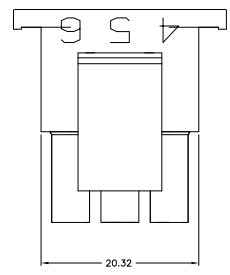
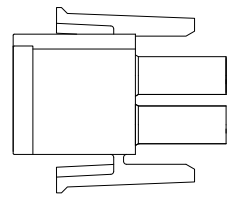
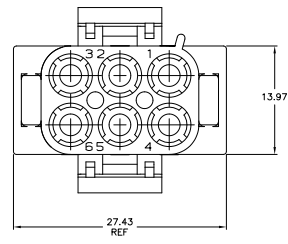
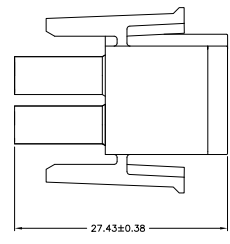

MM	IN	MM	IN
3.05	.120	27.43	1.080
2.29	.090	20.32	.800
0.38	.015	13.97	.550
0.13	.005	3.18	.125

CONVERSION TABLE

METRIC

THIS DRAWING IS A CONTROLLED DOCUMENT.		DATE	BY	APP
DATE	BY	APP	DATE	BY
UNIVERSAL MATE-N-LOK™		TE Connectivity		
PLUG, 8 CIRCUIT, UNIVERSAL MATE-N-LOK™		PART NUMBER		
2-480704-0		COLOR		
NATURAL		2-480704-0		
SIZE	DATE	ISSUE	REV	APP
A1	00779	4.1	2	AP3
CUSTOMER DRAWING				