

REV	DATE	BY	CHK	APPROV
DI	06APR2011	JK	HMR	

- MATERIALS AND FINISH:**  
 HOUSING: PA 6-6, UL 94-V0, COLOR:BLACK.  
 CLAMP: BRASS, NICKEL PLATED.  
 TERMINAL: BRASS, TIN PLATED.  
 CLAMPING SCREW: M3, BRASS, NICKEL PLATED.
- SUITABLE FOR 1.6-2.4mm. PCB THICKNESS.
  - END-TO-END STACKABLE W/INTERLOCK WITHOUT LOSS OF CENTERLINE SPACING.
  - WIRE SIZE RANGE: 12 - 30 AWG
  - RECOGNIZED UNDER THE COMPONENT PROGRAM OF UNDERWRITERS LABORATORIES INC. FILE No E60677.
  - IMO CERTIFICATE WITH SURVEILLANCE IN CONFORMITY WITH IEC 998-1/998-2-1.
  - NOT CUMULATIVE TOLERANCE.
  - WHITE INK STAMPING.
  - BUCHANAN LOGO TO APPEAR ON HOUSING, LOCATION OPTIONAL, WHERE SPACE PERMITS.

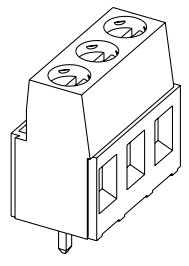

SEE DETAIL	30.48	6	3-796949-1
SEE DETAIL P	30.48	6	3-796949-1
SEE DETAIL N	10.16	2	3-796949-0
SEE DETAIL M	40.64	8	2-796949-9
SEE DETAIL L	40.64	8	2-796949-8
-	127.00	25	2-796949-5
-	121.92	24	2-796949-4
-	116.84	23	2-796949-3
-	111.76	22	2-796949-2
-	106.68	21	2-796949-1
-	101.60	20	2-796949-0
-	96.52	19	1-796949-9
-	91.44	18	1-796949-8
-	86.36	17	1-796949-7
-	81.28	16	1-796949-6
-	76.20	15	1-796949-5
-	71.12	14	1-796949-4
-	66.04	13	1-796949-3
-	60.96	12	1-796949-2
-	55.88	11	1-796949-1
-	50.80	10	1-796949-0
-	45.72	9	796949-9
-	40.64	8	796949-8
-	35.56	7	796949-7
-	30.48	6	796949-6
-	25.40	5	796949-5
-	20.32	4	796949-4
-	15.24	3	796949-3
-	10.16	2	796949-2
MARKING	A	POSN	PART NUMBER

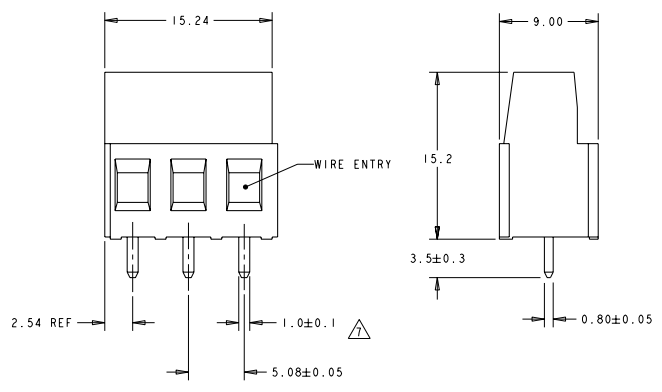
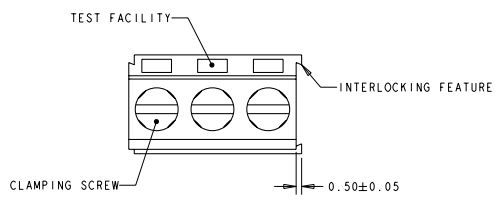
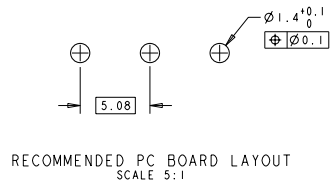

THIS DRAWING IS A CONTROLLED DOCUMENT. DATE: 22AUG2001

DESIGNED BY: S. WELDON  
 CHECKED BY: D. BLEVENOUR  
 APPROVED BY: D. BLEVENOUR

TE Connectivity  
**TE**  
 TERMINAL BLOCK  
 PCB MOUNT  
 W/INTERLOCK, 5.08mm PITCH

PRODUCT SPEC: -  
 APPLICATION SPEC: -  
 WEIGHT: -  
 MATERIAL: -  
 FINISH: -

SHEET: A200779 CASE CODE: 796949 DRAWING NO: -  
 RESTRICTED TO: -

CUSTOMER DRAWING SCALE: 4:1 SHEET 1 OF 2 REV D.1

4

3

2

1

THIS DRAWING IS UNPUBLISHED. RELEASED FOR PUBLICATION  
 ALL RIGHTS RESERVED. © Copyright 20

LOC	DISP	REVISIONS					
FT	0	P	LYR	DESCRIPTION	DATE	BY	APPR
		-		SEE SHEET 1	-	-	-

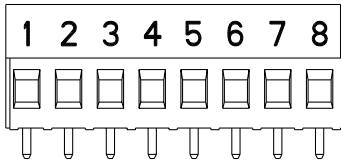

DETAIL L

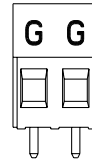

DETAIL N

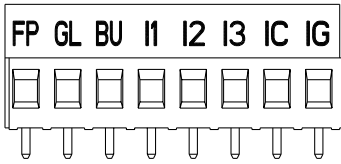

DETAIL M

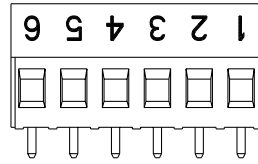

DETAIL P

THIS DRAWING IS A CONTROLLED DOCUMENT.		OWN	22AUG2001		
DIMENSIONS:		DESIGNED BY	S. WELDON		
mm		APPROVED BY	D. BLEVENOUR		
0 PLC 80 1 PLC 8.3 2 PLC 9.25 3 PLC 80 4 PLC 80 ANGLES 80°		DATE	22AUG2001		
MATERIAL		PRODUCT SPEC		NAME	
FINISH		APPLICATION SPEC		<b>TERMINAL BLOCK</b> PCB MOUNT W/INTERLOCK, 5.08mm PITCH	
-		WEIGHT		SHEET	A200779
-		CUSTOMER DRAWING		CASE CODE	C=796949
				DRAWING NO	
				RESTRICTED TO	
				SCALE	4:1
				SHEET	2 OF 2
				REV	D.1