Connector, Power Lock, Series I

1. SCOPE

1.1. Content

This specification covers performance, tests and quality requirements for TE Connectivity (TE) Power Lock connectors. These connectors are comprised of an assembled insulating housing and electrical contacts and are intended to provide connect/disconnect capabilities for commercial power handling applications. They are designed to accommodate wire sizes 18 through 12 AWG.

1.2. Qualification

When tests are performed on subject product line, procedures specified in 109 Series Test Specifications shall be used. All inspections shall be performed using applicable inspection plan and product drawing.

2. APPLICABLE DOCUMENTS

The following documents form a part of this specification to the extent specified herein. Unless otherwise specified, latest edition of the document applies. In the event of conflict between requirements of this specification and product drawing, product drawing shall take precedence. In the event of conflict between requirements of this specification and referenced documents, this specification shall take precedence.

2.1. TE Documents

- 109-1: General Requirements for Test Specifications
- 109 Series: Test Specifications as indicated in Figure 1
- 501-315: Qualification Test Report

3. REQUIREMENTS

3.1. Design and Construction

Product shall be of design, construction and physical dimensions specified on applicable product drawing.

3.2. Materials

- Contact: Copper, silver plating
- Housing: Polycarbonate or nylon, UL94V-0

3.3. Ratings

- Voltage: 600 volts AC
- Current: 31 amperes maximum, See Figure 5

NOTE

Maximum rated current that can be carried by this product is limited by maximum operating temperature of the housings (75°C), and temperature rise of the contacts (30°C). Variables which shall be considered for each application are wire size, connector size, contact material and ambient temperature.

- Temperature: -40 to 75°C

3.4. Performance and Test Description

Product is designed to meet electrical, mechanical and environmental performance requirements specified in Figure 1. Unless otherwise specified, all tests shall be performed at ambient environmental conditions per Test Specification 109-1.

3.5. Test Requirements and Procedures Summary

Test Description	Requirement	Procedure										
Examination of product.	Meets requirements of product drawing.	Visual, dimensional and functional per applicable quality inspection plan and Certificate of Conformance.										
ELECTRICAL												
Termination resistance.	2.5 milliohms maximum.	TE 109-6-7. Subject mated contacts assembled in housing to 50 mv maximum open circuit at 1 ampere maximum. See Figure 3.										
Insulation resistance.	1000 megohms minimum.	TE Spec 109-28-4. Test between adjacent contacts of mated samples ganged together.										
Dielectric withstanding voltage.	1500 vac at sea level.	TE Spec 109-29-1. Test between adjacent contacts of mated samples ganged together and a metal plate. See Figure 4.										
Temperature rise vs current.	30°C maximum temperature rise at specified current of 31 amperes ac.	TE Spec 109-45-1 and 109-151. Measure temperature rise vs current. See Figures 5 and 6.										
MECHANICAL												
Solderability.	Solderable area shall have minimum of 95% solder coverage.	TE Spec 109-11-2. Subject contacts to solderability.										
Crimp tensile.	<table border="1" style="margin-left: auto; margin-right: auto;"> <thead> <tr> <th>Wire Size (AWG)</th> <th>Crimp Tensile (Lbs maximum)</th> </tr> </thead> <tbody> <tr> <td>18</td> <td>20</td> </tr> <tr> <td>16</td> <td>30</td> </tr> <tr> <td>14</td> <td>50</td> </tr> <tr> <td>12</td> <td>50</td> </tr> </tbody> </table>	Wire Size (AWG)	Crimp Tensile (Lbs maximum)	18	20	16	30	14	50	12	50	TE Spec 109-16. Determine crimp tensile at maximum rate of 1 inch per minute.
Wire Size (AWG)	Crimp Tensile (Lbs maximum)											
18	20											
16	30											
14	50											
12	50											
Vibration, sinusoidal.	No discontinuities of 1 microsecond or longer duration. See Note.	TE Spec 109-21-1. Subject mated samples to 10-55-10 Hz traversed in 1 minute at .06 inch total excursion. 1.3 hours in each of 3 mutually perpendicular planes. See Figure 7.										

Figure 1 (continued)

Test Description	Requirement	Procedure										
Physical shock.	No discontinuities of 1 microsecond or longer duration. See Note.	TE Spec 109-26-2. Subject mated samples to 75 G's half-sine shock pulses of 6 milliseconds duration. 3 shocks in each direction applied along 3 mutually perpendicular planes, 18 total shocks.										
Durability.	See Note.	TE Spec 109-27. Mate and unmate samples for 20 cycles at maximum rate of 600 cycles per hour.										
Contact retention.	<table border="1"> <thead> <tr> <th>Wire Size (AWG)</th> <th>Retention Force (Lbs maximum)</th> </tr> </thead> <tbody> <tr> <td>18</td> <td>10</td> </tr> <tr> <td>16</td> <td>15</td> </tr> <tr> <td>14</td> <td>20</td> </tr> <tr> <td>12</td> <td>20</td> </tr> </tbody> </table>	Wire Size (AWG)	Retention Force (Lbs maximum)	18	10	16	15	14	20	12	20	TE Spec 109-30. Apply axial load to contacts by gripping wire and hold for 10 seconds.
Wire Size (AWG)	Retention Force (Lbs maximum)											
18	10											
16	15											
14	20											
12	20											
Mating force.	10 pounds maximum per contact pair.	TE Spec 109-42, Condition A. Measure force necessary to mate samples at maximum rate of .5 inch per minute.										
Unmating force.	1.75 pounds minimum per contact pair.	TE Spec 109-42, Condition A. Measure force necessary to unmate samples at maximum rate of .5 inch per minute.										
ENVIRONMENTAL												
Thermal shock.	See Note.	TE Spec 109-22. Subject mated samples to 5 cycles between -55 and 85°C.										
Humidity-temperature cycling.	See Note.	TE Spec 109-23-3, Condition B. Subject mated samples to 10 cycles between 25 and 65°C at 95% RH.										
Temperature life.	See Note.	TE Spec 109-43. Subject mated samples to temperature life at 85°C for 1000 hours.										
Mixed flowing gas.	See Note.	TE Spec 109-85-2. Subject mated samples to environmental class II for 14 days.										

NOTE

Shall meet visual requirements, show no physical damage and shall meet requirements of additional tests as specified in Test Sequence in Figure 2.

Figure 1 (end)

3.6. Product Qualification and Requalification Test Sequence

Test or Examination	Test Group (a)			
	1	2	3	4
	Test Sequence (b)			
Examination of product	1,10	1,9	1,8	1,3
Termination resistance	3,7	2,7		
Insulation resistance			2,6	
Dielectric withstanding voltage			3,7	
Temperature rise vs current		3,8		
Solderability				2
Crimp tensile	11			
Vibration	5	6(c)		
Physical shock	6			
Contact retention	9			
Durability	4			
Mating force	2			
Unmating force	8			
Thermal shock			4	
Humidity-temperature cycling			5	
Temperature life		5		
Mixed flowing gas		4		

NOTE

- (a) See paragraph 4.1.A.
- (b) Numbers indicate sequence in which tests are performed.
- (c) Discontinuities shall not be measured. Energize at 18°C level for 100% loadings per Test Specification 109-151.

Figure 2

4. QUALITY ASSURANCE PROVISIONS

4.1. Qualification Testing

A. Sample Selection

Samples shall be prepared in accordance with applicable Instruction Sheets and shall be selected at random from current production. Test group 1 shall consist of 5 contact pairs, each crimped to 4 appropriate wire sizes for single connector assembly. Test group 2 shall consist of 2 connector assemblies, each crimped to 4 appropriate wire sizes for multiple (5 position) connector assemblies. Test group 3 shall consist of 2 assemblies, each mounted on printed circuit boards with mating connectors crimped to 4 appropriate wire sizes. Each contact shall be attached to 1 end of a 24 inch length of wire with a suitable terminal applied to the other for series circuit wiring. Test group 4 shall consist of contacts only.

B. Test Sequence

Qualification inspection shall be verified by testing samples as specified in Figure 2.

4.2. Requalification Testing

If changes significantly affecting form, fit or function are made to product or manufacturing process, product assurance shall coordinate requalification testing, consisting of all or part of original testing sequence as determined by development/product, quality and reliability engineering.

4.3. Acceptance

Acceptance is based on verification that product meets requirements of Figure 1. Failures attributed to equipment, test setup or operator deficiencies shall not disqualify product. When product failure occurs, corrective action shall be taken and samples resubmitted for qualification. Testing to confirm corrective action is required before resubmittal.

4.4. Quality Conformance Inspection

The applicable quality inspection plan will specify sampling acceptable quality level to be used. Dimensional and functional requirements shall be in accordance with applicable product drawing and this specification.

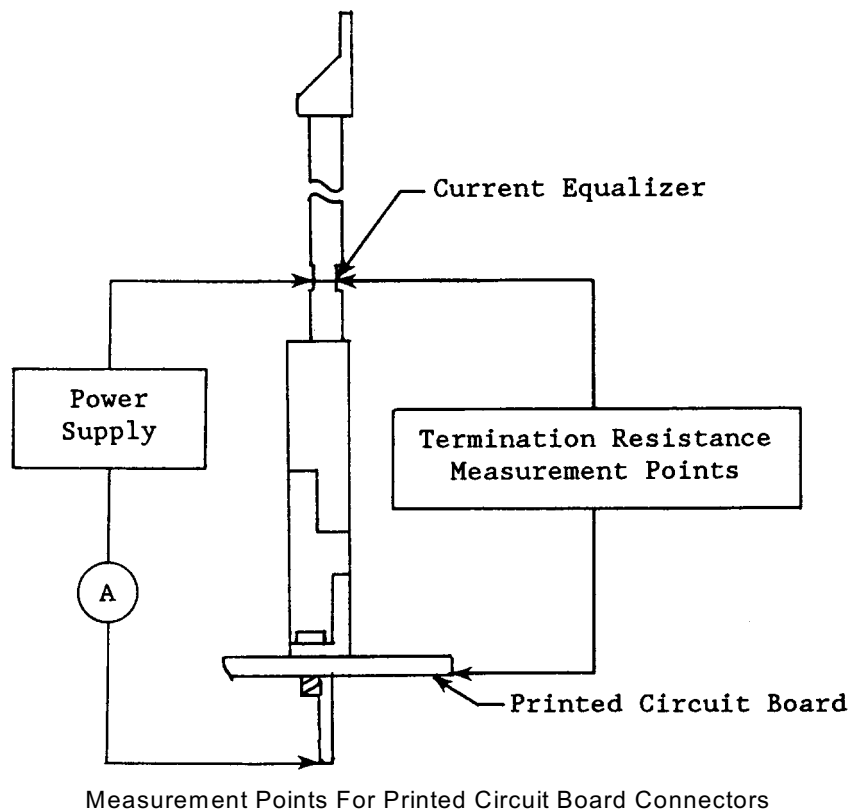
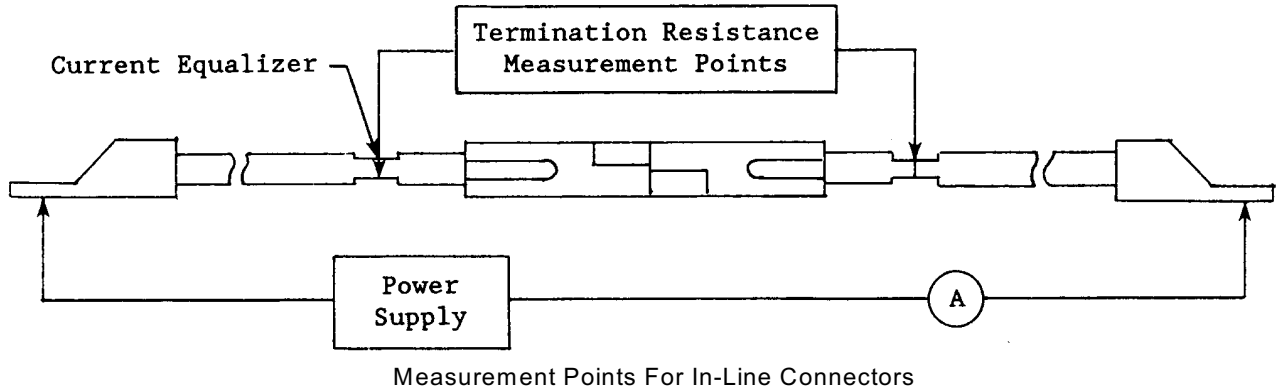
NOTE

- (a) Current equalizers shall be soldered onto wire at termination resistance measurement points.
- (b) Current equalizers shall be located 3 inches back from wire receiving end of each contact.
- (c) An equal wire length (EWL), equal to the distance between voltage probe points, shall be measured for resistance.
- (d) Termination resistance equals millivolt drop divided by test current less EWL resistance.

Figure 3
Termination Resistance Measurement Points

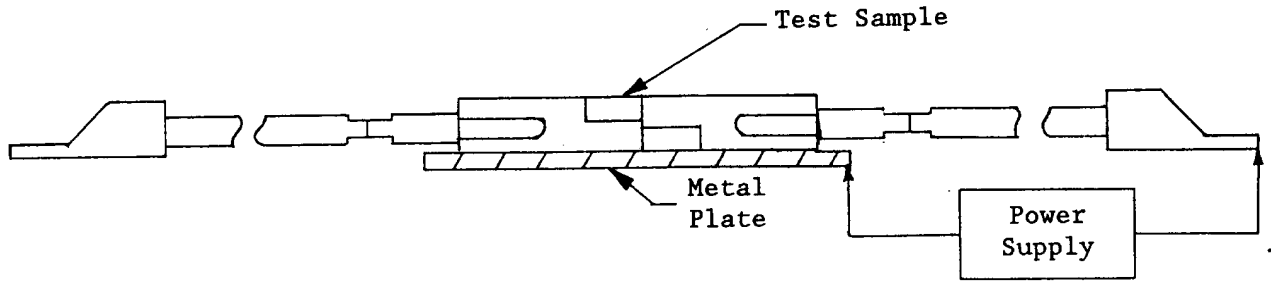

Figure 4
Dielectric Withstanding Voltage

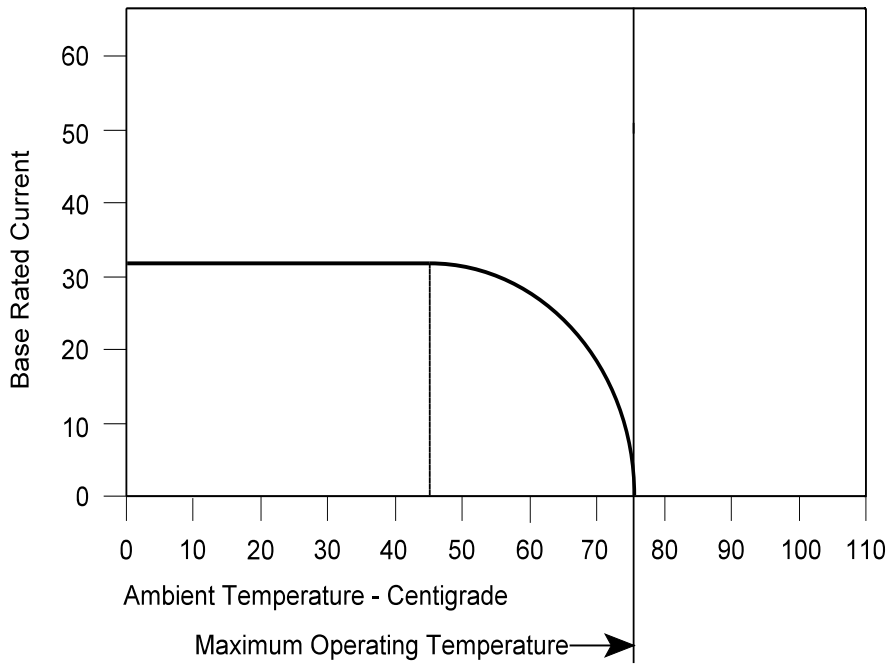

Figure 5A
Current Carrying Capability

Percent Connector Loading	Wire Size AWG			
	18	16	14	12
Single Contact	.56	.71	.85	1
50	.51	.64	.78	.91
100	.43	.55	.66	.78

NOTE

- (a) Unless specifically permitted within NEC, overcurrent protection for the following conductor types shall not be exceeded.
 1. 7 amperes for 18 AWG copper wire
 2. 10 amperes for 16 AWG copper wire
 3. 15 amperes for 14 AWG copper wire
 4. 20 amperes for 12 AWG copper wire
- (b) To determine acceptable current carrying capacity for percentage connector loading and wire gage indicated, use Multiplication Factor (F) from above chart and multiply it times Base Rated Current for a single circuit at maximum ambient operating temperature as shown in Figure 5A.

Figure 5B
Current Rating

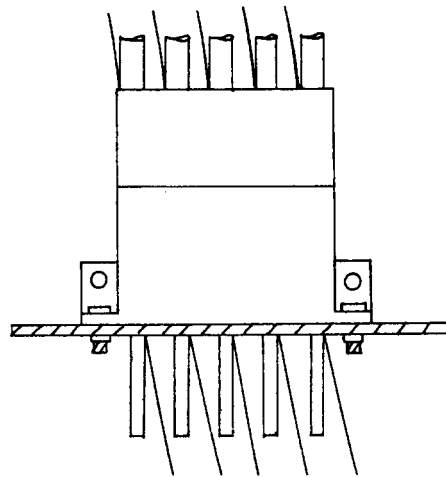
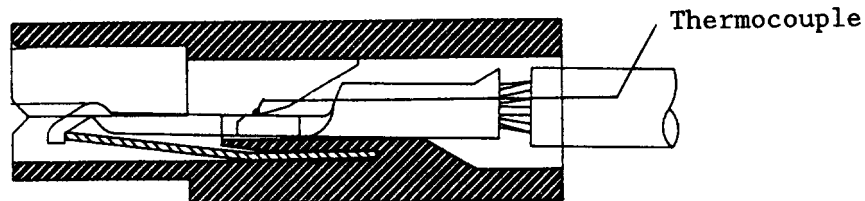

NOTE

- (a) Thermocouples shall be spot welded to contact near intersection of tongue and barrel as shown and coated with thermal conductive epoxy.
- (b) Thermocouple shall exit housing by running down side of wire barrel.
- (c) Printed circuit board shall be modified to allow thermocouple wire to pass through boards.

Figure 6
Thermocouple Mounting

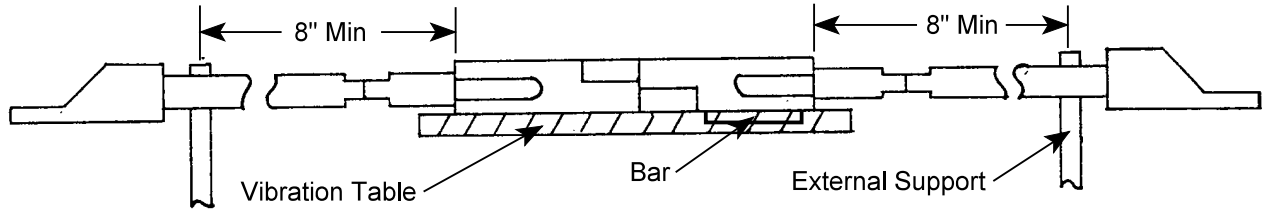

NOTE

- (a) Clamp connector rigidly to vibration table.
- (b) Clamp wire a minimum of 8 inches from connector on external support providing sufficient slack in wire to preclude resonance.

Figure 7
Vibration Mounting Fixture

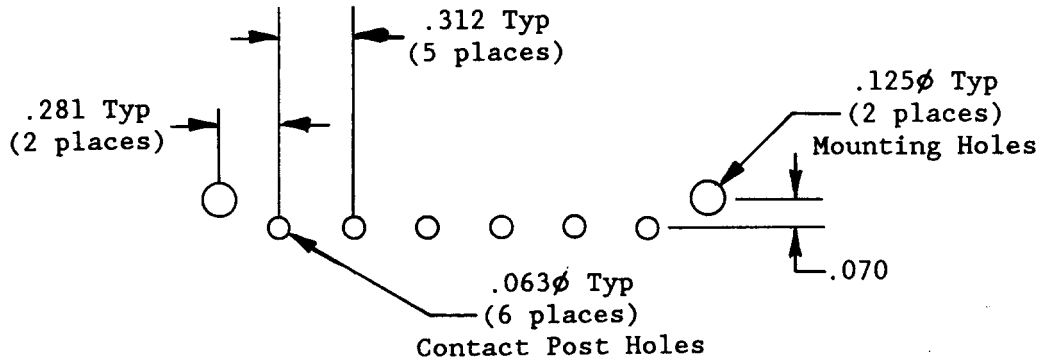

Figure 8
Printed Circuit Board Layout