

4

3

2

1

THIS DRAWING IS UNPUBLISHED. RELEASED FOR PUBLICATION APR. 2001.  
 COPYRIGHT © 2001 BY TYCO ELECTRONICS CORPORATION. ALL RIGHTS RESERVED.

REVISONS		DATE	OWN	APPD
NO.	DESCRIPTION			
0	RELEASED	FJAO-059B-04	28SEP04	SS YF

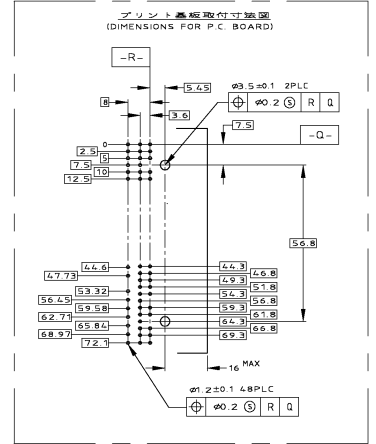
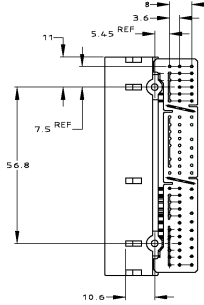
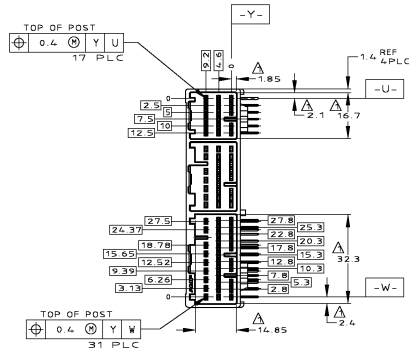
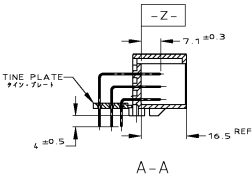
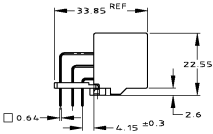
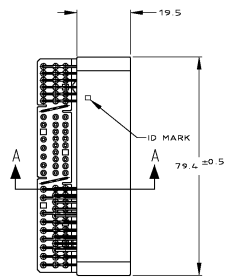

- △ MEASURED AT THE SECTION 2mm FROM Z.
- △ CIRCUIT NUMBERS : SEE FIG 1
- 3. PART NO OF PLUG HOUSINGS TO BE MATED  
 17P: 353027  
 31P: 353031
- 4. RECOMMENDED SCREW: PAN-HEADED, TYPE 2 TAPPING SCREW OF 3DIA X 6LEN(MAX) (JIS B1115, B1122).
- 5. FASTENING TORQUE FOR SCREW: 0.392N·m MAX.
- △ TINE PLATE COLOR : NATURAL

- △ Z面より2mmの位置で測定
- △ 回路番号: FIG 1 参照
- 3. 接合相手ハウジングの型番  
 17P: 353027  
 31P: 353031
- 4. 推奨取付ねじ: JIS B1115-B1122タップ径ねじ、なべ2種  
 径が3.0、長さ6以下
- 5. ねじ締付トルク: 0.392N·m MAX
- △ タイム-プレートの色は、自然色

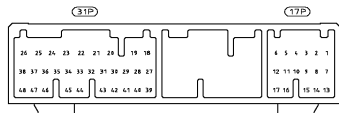

△ FIG 1 CIRCUIT NUMBERS

TOLERANCE UNLESS OTHERWISE SPECIFIED
0-≦ 10 : ±0.2
10-≦ 30 : ±0.25
30-≦ 100 : ±0.3
ANGLE : ±3°

108-5529	PAPER BOX タフボール	PLASTIC TUBE プラスチックチューブ	PRE-TIN X 48	GRAY	1747962-1
PRODUCT SPEC 製品規格	OUTER 外装	INNER 内装	CONTRACT TYPE 仕上り	COLOR (色) 色	PART NO (型番)
THIS DRAWING IS A CONTROLLED DOCUMENT.		DWG: SAKAGUCHI 28SEP04		tyco Tyco Electronics AMP K.K.	
CHK: SAKURAI 28SEP04		APPD: Y. FUJIWARA 28SEP04		Kawasaki, Japan	
DIMENSIONS: MM		MATERIAL: PBT, COPPER ALLOY		040 III HIGH DENSITY CONNECTOR 48P CAP HOUSING ASSY	
FINISH: SEE TABLE		WEIGHT: 21.5		SCALE: 1:1	
MATERIAL: PBT, COPPER ALLOY		CUSTOMER DRAWING		RESTRICTED TO	
				SEE DATE CODE DRAWING NO: A2 00779 © 1747962	
				SHEET 1 OF 1 REV 0	