

---

**040 II /070 II Hybrid I/O Connector MK-II for Wire-to-Board Termination****1. Scope :****1.1 Contents :**

This specification covers the requirements for product performance, test methods and quality assurance provisions of 040 II /070 II Hybrid I/O Connector MK-II for Wire-to-Board Termination. Applicable product descriptions and part numbers are as shown in Appendix 1.

**2. Applicable Documents :**

The following documents form a part of this specification to the extent specified herein. In the event of conflict between the requirements of this specification and the product drawing, the product drawing shall take precedence. In the event of conflict between the requirements of this specification and the referenced documents, this specification shall take precedence.

**2.1 AMP Specifications :**

- A. 109-5000: Test Specification, General Requirements for Test Methods.  
Application Specification
  
- B. 114-5159 : Crimping 040 II Series Receptacle & Tab Contact  
114-5160 : Crimping 070 II Series Receptacle & Tab Contact  
114-5198 : Crimping 070 III(Unsealed) Receptacle Contact  
501-5303 : Test Report

**2.2 Commercial Standards and Specifications :**

- A. JASO D605                      Multi-pole Connector for Automobiles
- B. JASO D7101                    Test Methods for Plastic Molded Parts
- C. JIS C3406                      Low Voltage Wires and Cables for Automobiles
- D. JIS D0203                      Method of Moisture, Rain and Spray Test for Automobile Parts
- E. JIS D0204                      Methods of High and Low Temperature Test for Automobile Parts
- F. JIS D1601                      Vibration Testing Method for Automobile Parts
- G. JIS R5210                      Portland Cement
- H. MIL-STD-202                  Testing Method 208: Method of Soldering

**3. Requirements :****3.1 Design and Construction :**

Product shall be of the design, construction and physical dimensions specified in the applicable product drawing.

**3.2 Materials :****A. Contact :**

a. Receptacle Contact : Pre-Tin Brass or Pre-tin Phosphor Bronze, or Plain Brass with Selective Gold plating over nickel under plating, or plain Phosphor Bronze with Selective Gold plating over nickel under plating.

b. Tab Contact : Pre-Tinned Brass or Selective-Tin  
Plain Brass with Selective Gold plating over nickel under plating.

B. Housing : PBT resin

**3.3 Ratings :**

Temperature Rating: -30°C to 105°C

**3.4 Performance and Test Descriptions :**

The product shall be designed to meet the electrical, mechanical and environmental performance requirements specified in Fig.2. All tests shall be performed in the room temperature, unless otherwise specified.

**3.5 Test Requirements and Procedures Summary:**

Para.	Test Items	Requirements	Procedures
3.5.1	Confirmation of Product	Product shall be conforming to the requirements of applicable product drawing and Application Specification. No. 114-5159, 114-5160	Visually, dimensionally and functionally inspected per applicable quality inspection plan.
Electrical Requirements			
3.5.2	Termination Resistance (Specified Current)	(040 II) 10mΩ Max. (Initial) 20mΩ Max. (Final) (070 II, III) 3mΩ Max. (Initial) 10mΩ Max. (Final)	Measure initial millivolt drop of contact test circuit in mated connectors, Fig.3 AMP Spec. 109-5311-2
3.5.3	Termination Resistance (Low Level)	(040 II) 10mΩ Max. (Initial) 20mΩ Max. (final) (070 II, III) 3mΩ Max. (Initial) 10mΩ Max. (final)	Subject mated contacts assembled in housing to closed circuit current of 10mA Max. at open circuit voltage of 20mVMax. Fig.3. AMP Spec. 109-5311-1
3.5.4	Dielectric Strength	No creeping discharge nor flashover shall occur.	1kVAC for 1 minute. Test between adjacent circuits of mated/unmated connectors. AMP Spec. 109-5301
3.5.5	Insulation Resistance	100MΩ Min.	Impressed voltage 500V DC. Test between adjacent circuits of mated connectors. AMP Spec. 109-5302
3.5.6	Current Leakage	1mA Max.	12V DC impressed 1min. AMP Spec. 109-5312
3.5.7	Temperature Rising	60°CMax. under loaded specified current.	Measure temperature rising by energized current. AMP Spec. 109-5310
3.5.8	Current Cycling	(040 II) 20mΩ Max. (Final) (070 II, III) 10mΩ Max. (Final) No ignition is allowed during the test.	Applied Current : Fig 6 & 7. 45minutes "ON", 15minutes "OFF" 200 cycles. AMP Spec. 109-5308

Fig. 1 (To be continued)

Physical Requirements						
Para.	Test Items	Requirements	Procedures			
3.5.9	Vibration(High Frequency)	No electrical discontinuity greater than 1 $\mu$ sec. Shall occur. (040 II) 20m $\Omega$ Max.(Final) (070 II, III) 10m $\Omega$ Max.(Final)	Vibration Frequency : 20~200~20Hz/3min. Accelerated Velocity : 44.1m/s <sup>2</sup> (4.5G)			
			Vibration Direction	Up and Down	Back and Forth	Right and Left
			Direction	4 hours	2 hours	2 hours
			AMP Spec. 109-5202			
3.5.10	Vibration + Current Cycle	No electrical discontinuity greater than 1 $\mu$ sec. Shall occur. (040 II) 20m $\Omega$ Max.(Final) (070 II, III) 10m $\Omega$ Max.(Final)	Vibration Frequency : 20~200~20Hz/3min. Accelerated Velocity : 44.1m/s <sup>2</sup> (4.5G)			
			Vibration Direction	Up and Down	Back and Forth	Right and Left
			Direction	4 hours	2 hours	2 hours
			Test Current : (040 II) 4.4A DC (070 II, III) 10A DC			
3.5.11	Contact Mating Force	040 II Series : 5.8N Max. 070 II, III Series : 5.8N Max.	Operation Speed : 100mm/min. Measure the force required to mate contacts. AMP Spec. 109-5206			
3.5.12	Contact Unmating Force	040 II Series : 0.98N Min. (Sn) 0.69N Min. (Au) 070 II, III Series : 0.98N Min. (Sn) 0.69N Min. (Au)	Operation Speed : 100mm/min. Measure the force required to unmate contacts. AMP Spec. 109-5206			
3.5.13	Connector Mating Force	12Pos. 69N Max. 16Pos. 69N Max. 22Pos. 88.3N Max. 26Pos. 98.1N Max.	Operation Speed : 100mm/min. Measure the force required to mate contacts. AMP Spec. 109-5206			
3.5.14	Connector Unmating Force	12Pos. 69N Max. 16Pos. 69N Max. 22Pos. 88.3N Max. 26Pos. 98.1N Max.	Operation Speed : 100mm/min. Measure the force required to unmate contacts. AMP Spec. 109-5206			
3.5.15	Housing Locking Strength	98N Min.	Measure housing locking strength. Operation Speed : 100mm/min. AMP Spec. 109-5210			
3.5.16	Contact Insertion Force	9.8N Max. per contact	Measure the force required to insert contacts into housing. AMP Spec. 109-5211			

Fig. 1 (To be continued)

Para.	Test Items	Requirements			Procedures
3.5.17	Contact Retention Force (Pre-Lock)	49N Min.			Apply an axial pull-off load to crimped wire. Operation Speed: 100mm/min. AMP Spec. 109-5212
3.5.18	Contact Retention Force (Secondary Lock)	78N Min.			Measure contact retention force with secondary lock set in effect. Operation Speed: 100mm./min.
3.5.19	Crimp Tensile Strength	Wire Size		Crimp Tensile	Apply an axial pull-off load to crimped wire of contact secured on the tester. Operation Speed: 100mm/min. AMP Spec. 109-5205
		mm <sup>2</sup>	(AWG)	N	
		0.3	#22	58 min.	
		0.5	#20	88 min.	
		0.85	#18	127 min.	
1.25	#16	177 min.			
3.5.20	Durability (Repeated Mate/Unmating)	(040 II) 20mΩ Max.(Final) (070 II, III) 10mΩ Max.(Final)			Operation Speed: 100mm/min. No. of Cycles: 30 Cycles. AMP Spec. 109-5213
3.5.21	Resistance to "Kojiri"	(040 II) 20mΩ Max.(Final) (070 II, III) 10mΩ Max.(Final)			Repeated mating/ unmating by hand, 30 cycles AMP Spec. 109-5215
3.5.22	Solderbility	Wet Solder Coverage: 95% Min. (Plated Area only)			Solder Temperature: 230±5°C Immersion Duration: 3±0.5 seconds Flux: Alpha 100 AMP Spec. 109-5203
					Matte Tin plating only Solder bath : Sn-3Ag-0.5Cu Solder Temperature :250±5°C Immersion Duration :5±0.5sec. Flux :ULF-300R
3.5.23	Handling Ergonomic	No abnormalities allowed in manual mating/unmating handling.			Manually operated
3.5.24	Double Lock Plate Locking Strength	59N Max.			Operation Speed: 100mm/min. Measure the force required to lock the double lock plate.

Fig. 1 (To be continued)

Environmental Requirements			
Para.	Test Items	Requirements	Procedures
3.5.25	Thermal Shock	(040 II) 20mΩ Max.(Final) (070 II, III) 10mΩ Max.(Final)	-30°C/120min, 80°C/120min. Making this a cycle, repeat 5 cycles. AMP Spec. 109-5103
3.5.26	Humidity, Steady State	Insulation resistance (Final) 100MΩ Min. Termination resistance (040 II) 20mΩ Max.(Final) (070 II, III) 10mΩ Max.(Final)	Mated/unmated Connector, 90~95% R.H., 60°C 96 hours AMP Spec. 109-5105
3.5.27	Industrial Gas (SO <sub>2</sub> )	(040 II) 20mΩ Max.(Final) (070 II, III) 10mΩ Max.(Final)	SO <sub>2</sub> Gas : 10ppm, 95% R.H. 20°C, 24 hours AMP Spec. 109-5107
3.5.28	Temperature Life (Heat Aging)	(040 II) 20mΩ Max.(Final) (070 II, III) 10mΩ Max.(Final)	120°C, Duration: 120 hours AMP Spec. 109-5104
3.5.29	Resistance to Cold	(040 II) 20mΩ Max.(Final) (070 II, III) 10mΩ Max.(Final)	-50°C ± 5°C, 120 hours AMP Spec. 109-5108
3.5.30	Dust Bombardment	(040 II) 20mΩ Max.(Final) (070 II, III) 10mΩ Max.(Final)	Subject JIS R5210 cement blow of 1.5kg per 10 seconds in 15 minutes intervals for 90 minutes. AMP Spec. 109-5110

Fig.1 (End)

**4. Product Qualification Test Sequence**

Test Items	Test Group										
	1	2	3	4	5	6	7	8	9	10	11
	Test Sequence (a)										
Confirmation of Product	1	1	1	1	1,9	1,11	1,11	1,13	1,16	1,11	1
Termination Resistance (Specified Current)			4								
Termination Resistance (Low Level)			3		3,5,7	3,6,8	3,6,8	3,6,8,10	2,7,9,14	3,6,8	
Dielectric Strength				3					4,12		
Insulation Resistance				2					3,11		
Current Leakage				4					5,10		
Temperature Rising			5								
Current Cycling								9			
Vibration (High Frequency)								7			
Vibration + Current Cycle										7	
Contact Mating Force	2										
Contact Unmating Force	3										
Connector Mating Force			2			2,10	2,10	2,12		2,10	
Connector Unmating Force			6			4,9	4,9	4,11		4,9	
Housing Locking Strength		2									
Contact Insertion Force											2
Contact Retention Force(Pre-Lock)											3
Contact Retention Force(Secondary Lock)			7								
Crimp Tensile Strength	4										
Durability (Repeated Mate/Unmating)									6		
Resistance to "Kojiri"							5	5		5	
Solderability					2						
Handling Ergonomics					8				15		
Double Lock Plate Locking Strength											4
Thermal Shock					4						
Humidity, Steady State					6				8		
Industrial Gas (SO <sup>2</sup> )									13		
Temperature Life(Heat Aging)						5					
Resistance to Cold						7					
Dust Bombardment							7				

Fig. 2

(a) Numbers indicate sequence in which tests are performed.

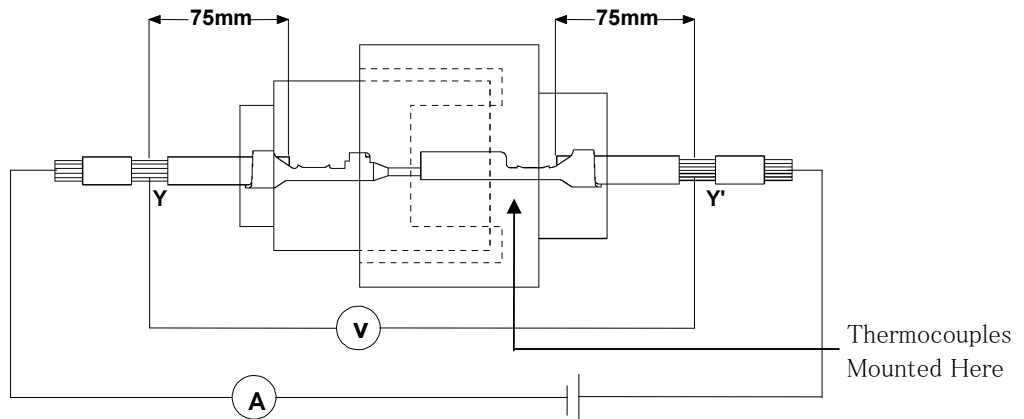

From the measured readings, deduct the resistance of the 150mm long wire used for termination. When testing for rated current measurement, apply 12V DC, 1A to the circuit. For obtaining uniformity of the current density on the probing points Y-Y', apply soldering on the probing points prior to testing.

**Fig.3 Measurement of Termination Resistance**

**Measuring Apparatus**

Wrap metallic foil to cover the connector surface.

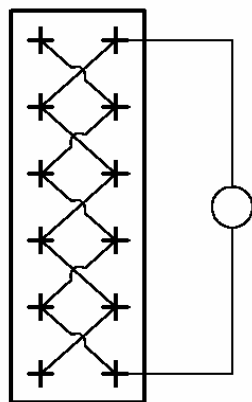

Between the Adjacent Contacts

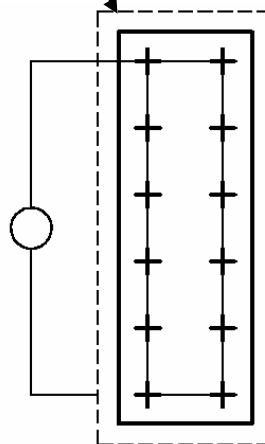

Between the Contacts and Housing

**Fig.4**



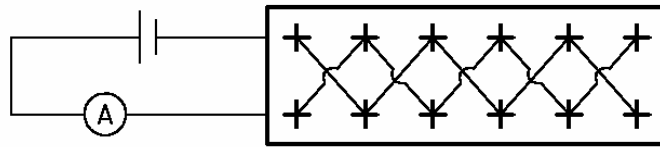

Fig.5

Maximum Allowable Current ( I max.)

Wire Size (mm <sup>2</sup> )	Allowable Current (DC A)
0.3	8
0.5	11
0.85	15
1.25	19
2.0	25

Fig.6

Reduction Coefficient (Kd)

Number of Energized Contacts	Reduction Coefficient
1	1
2~3	0.75
4~5	0.6
6~8	0.55
9~12	0.5
13~	0.4

Fig.7

- (1)  $I_1 = Kd \cdot I_{max}$  .....Current applied to all positions
- (2)  $I_2 = I_{max}$  .....Current applied to every other positions in multiple connector

Wire Size (mm <sup>2</sup> )	Test Method I		Test Method II	
	Test Current (A)	Duration (Minutes)	Test Current (A)	Duration (Seconds)
0.3	25	5	50	5
0.5	30		80	
0.85	40		110	
1.25	45		170	
2.0	70		250	

**Fig.8**

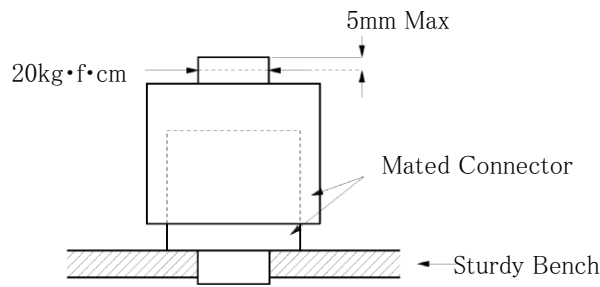

**Fig.9**

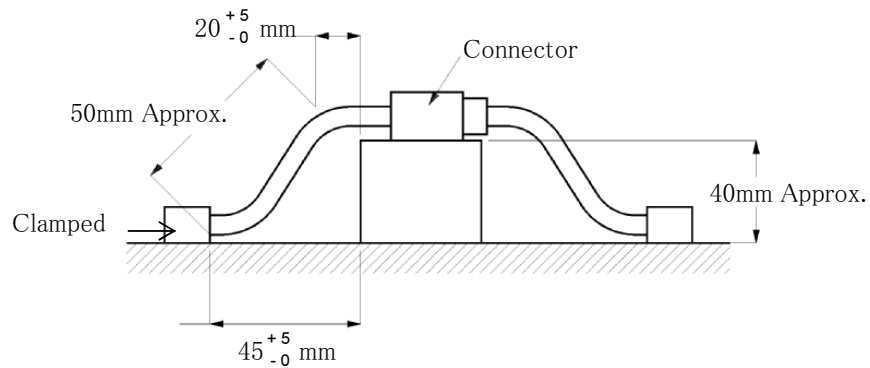

**Fig.10**

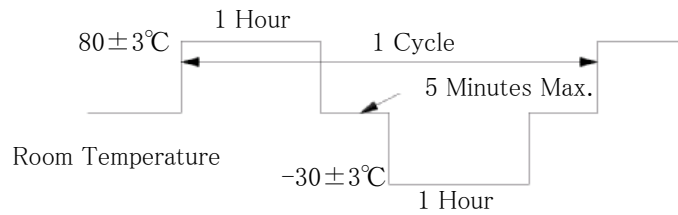

**Fig.11**

The applicable product descriptions and part numbers are as shown in Appendix 1.

Appendix 1

Prod. P/N	Description
X-178845-X	040/070 Hybrid I/O Conn. MK- II 12Pos. Plug Housing. Assembly (Signal)
X-178881-X	040/070 Hybrid I/O Conn. MK- II 12Pos. Plug Housing. Assembly (Power)
X-178795-X	040/070 Hybrid I/O Conn. MK- II 16Pos. Plug Housing. Assembly
X-178883-X	040/070 Hybrid I/O Conn. MK- II 16Pos. Plug Housing. Assembly
X-177545-X	040/070 Hybrid I/O Conn. MK- II 16Pos. Plug Housing. Assembly
X-178798-X	040/070 Hybrid I/O Conn. MK- II 22Pos. Plug Housing. Assembly
X-178801-X	040/070 Hybrid I/O Conn. MK- II 26Pos. Plug Housing. Assembly
X-178885-X	040/070 Hybrid I/O Conn. MK- II 26Pos. Plug Housing. Assembly
X-178888-X	040/070 Hybrid I/O Conn. MK- II 26Pos. 3Row Plug Housing. Assembly
X-178897-X	040/070 Hybrid I/O Conn. MK- II 26Pos. 3Low Profile Plug Housing. Assembly
X-175571-X	040/070 Hybrid I/O Conn. 26Pos. Cap Housing. Assembly
X-178811-X	040/070 Hybrid I/O Conn. 26Pos. Cap Housing. Assembly
X-175569-X	040/070 Hybrid I/O Conn. 26Pos. Cap Housing. Assembly
X-178762-X	040/070 Hybrid I/O Conn. 26Pos. Cap Housing. Assembly
X-5178762-X	
X-176206-X	040/070 Hybrid I/O Conn. 26Pos. 3Row Cap Housing. Assembly
X-178900-X	040/070 Hybrid I/O Conn. 26Pos. 3Row Low Profile Cap Housing. Assembly
X-178209-X	040/070 Hybrid I/O Conn. 26Pos. Low Profile Cap Housing. Assembly
X-175444-X	040/070 Hybrid I/O Conn. 34Pos. Cap Housing. Assembly
X-5175444-X	
X-176255-X	040/070 Hybrid I/O Conn. 34Pos. Cap Housing. Assembly (30 Pos.)
X-175521-X	040/070 Hybrid I/O Conn. 38Pos. Cap Housing. Assembly

Prod. P/N	Description
X-178093-X	040/070 Hybrid I/O Conn. 38Pos. Cap Housing. Assembly
X-353245 -X	040/070 Hybrid I/O Conn. 38Pos. Cap Housing. Assembly (V-Type)
X-175446-X	040/070 Hybrid I/O Conn. 42Pos. Cap Housing. Assembly
X-5175446-X	
X-176242-X	040/070 Hybrid I/O Conn. 42Pos. Cap Housing. Assembly
X-177542-X	040/070 Hybrid I/O Conn. 42Pos. Cap Housing. Assembly
X-174917-X	040/070 Hybrid I/O Conn. 48Pos. Cap Housing. Assembly
X-5174917-X	
X-175448-X	040/070 Hybrid I/O Conn. 54Pos. Cap Housing. Assembly
X-1318471-X	040/070 Hybrid I/O Conn. 54Pos. Cap Housing. Assembly without 16Pos.
X-174518-X	040/070 Hybrid I/O Conn. 64Pos. Cap Housing. Assembly
X-5174518-X	
X-178764-X	040/070 Hybrid I/O Conn. 64Pos. Cap Housing. Assembly
X-177609-X	040/070 Hybrid I/O Conn. 64Pos. Cap Housing. Assembly
X-176122-X	040/070 Hybrid I/O Conn. 64Pos. Cap Housing. Assembly
X-174915-X	040/070 Hybrid I/O Conn. 76Pos. Cap Housing. Assembly
X-176142-X	040/070 Hybrid I/O Conn. 76Pos. Cap Housing. Assembly
X-178780-X	040/070 Hybrid I/O Conn. 76Pos. Cap Housing. Assembly
X-353468-X	040/070 Hybrid I/O Conn. 76Pos. Cap Housing. Assembly
X-353469-X	040/070 Hybrid I/O Conn. 76Pos. Cap Housing. Assembly
X-175265-X	040 II S Receptacle Contact (Pre-Tin)
X-175266-X	040 II S Receptacle Contact (Selective Gold)
X-175268-X	070 II S Receptacle Contact (Pre-Tin)
X-175275-X	070 II S Receptacle Contact (Selective Gold)
X-175269-X	070 II M Receptacle Contact (Pre-Tin)
X-175276-X	070 II M Receptacle Contact (Selective Gold)
X-1318629-X	070III ML Receptacle Contact (Pre-Tin)

※ Note: Parts number is consisted from listed base number and 1 digit numeric prefix and suffix with dash.

Refer to catalog or customer drawing for specific part numbers for each base number. When prefix is zero, zero and dash are omitted.