

ZEICHNUNGSGRUPPE: 42 POS. MIXED TAB HOUSING
 ZEICHNUNG: 968393
 REV.: A1
 DATUM: 02. JUL. 1988
 NAME: A. NEHILL

Bemerkungen
 NOTES
 ⚠ Einfall zulässig bis
 PERMISSIBLE COLLAPSE TO

Zielsetzung fuer Leistungsdaten /
 Produktspezifikation 108-18478-1
 DESIGN OBJECTIVES / PRODUCTSPEC. 108-18478-1

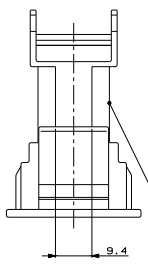
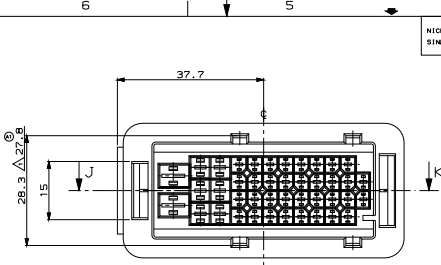

SAAB
 SAAB NO.
 XPBT-0F30-C

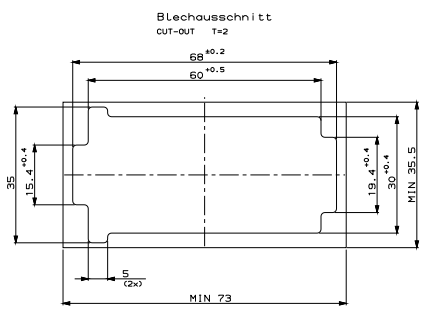
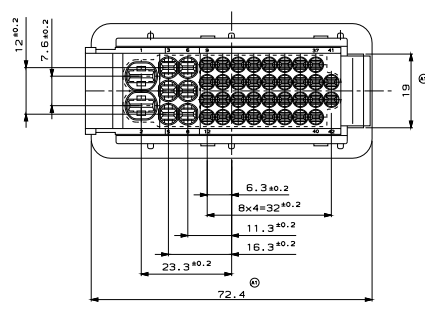
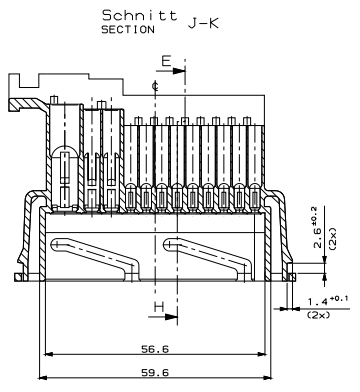
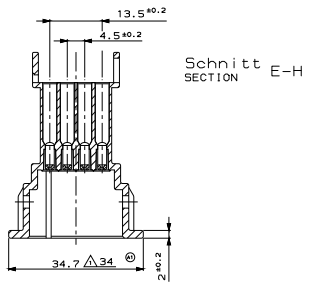
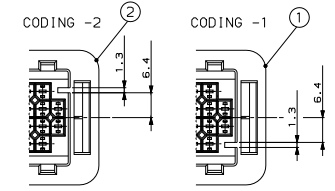
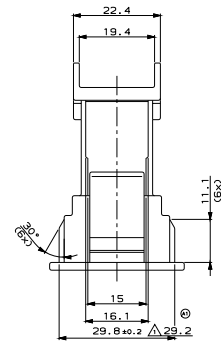
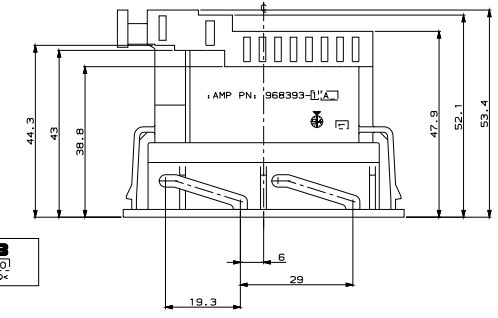

FOR SAAB ONLY

ZEICHNUNG GÖLTIG AB									
AMP									
AMP DEUTSCHLAND GmbH D-83205 Lengen									
4811246	968393-2	A	2	1	TAB HOUSING COD.2	PBT GF30	GREY	42 POS. MIXED TAB HOUSING	
4811230	968393-1	A	1	1	TAB HOUSING COD.1	PBT GF30	BLACK		
SAAB NO.	BESTELL-NR.	REV.	POS.	STÜCK	BENENNUNG EINZELTEIL	HERVSTÜPF	OBERFLÄCHE	NICHT TOLERIERTES MASS	FORM
								± 0,3 mm	A1
H. Kressmann								968393	
B. Buback		31-08-88		H. Kressmann		1 von 1		REV.	A1