

PROJEKT-NR. 963179
 ZEICHNUNG-NR. 963179
 VERZEICHNIS-NR. 963179
 DATUM 22.02.96
 NAME B. RUDOLPH

ANDERUNGEN DIE DEN TECHNISCHEN FORTSCHRITT DIENEN BEHALTEN WIR UNS VOR
 VERTRAULICH
 ZEICHNUNG GESCHÜTZT DURCH
 RECHT
 AMP 1996
 AMP DEUTSCHLAND GMBH
 ALLE RECHTE VORBEHALTEN

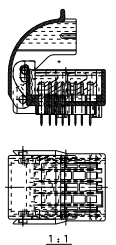

PCB LAYOUT

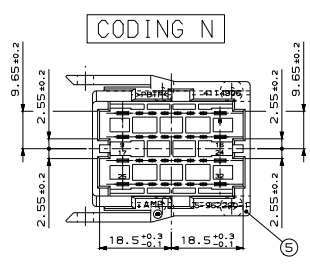
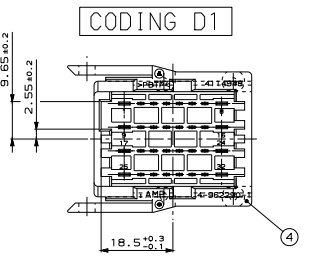
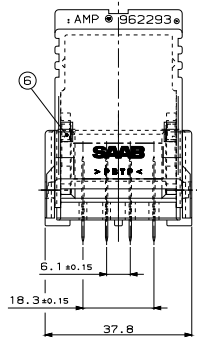
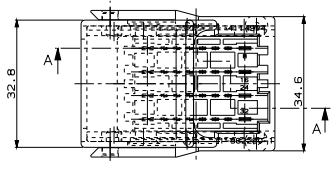
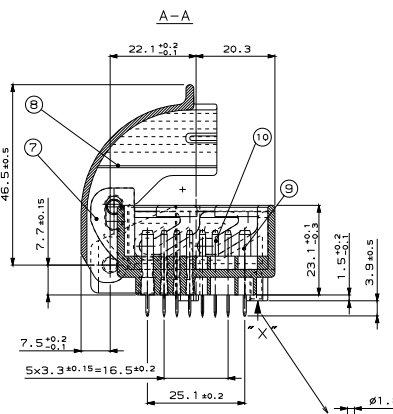
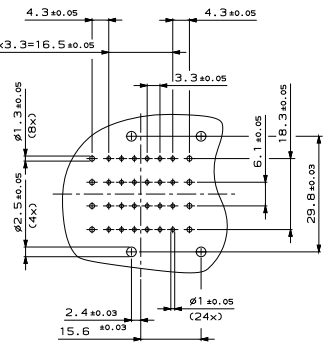

CODING A1

CODING B1

CODING C1

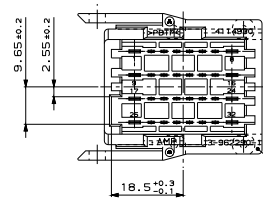
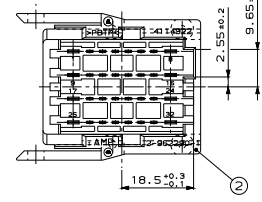
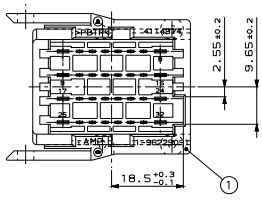

ORDER-NO.	REV.	POS.	PIECE	COMPONENT-NAME	MATERIAL	SURFACE COLOUR	NOT TOLERANCE VALUE	FORMY	REMARKS
5-963179-1	B	10	24	TAB 1.6 MM (22 MM)	CuSn4	PRE-TINNED			
		9	8	TAB 3.0 MM (22 MM)	CuSn4	PRE-TINNED			
		8	1	LOCKING-CLIP	PBT	BLACK			
		7	1	SLIDE (LEFT)	PBT	RED			
		6	1	SLIDE (RIGHT)	PBT	RED			
		5	1	32 POS. TAB HSG., COD. N	PBT	WHITE			
		10	24	TAB 1.6 MM (22 MM)	CuSn4	PRE-TINNED			
		9	8	TAB 3.0 MM (22 MM)	CuSn4	PRE-TINNED			
		8	1	LOCKING-CLIP	PBT	BLACK			
		7	1	SLIDE (LEFT)	PBT	RED			
4-963179-1	B	6	1	SLIDE (RIGHT)	PBT	RED			
		4	1	32 POS. TAB HSG., COD. D1	PBT	BROWN			
		10	24	TAB 1.6 MM (22 MM)	CuSn4	PRE-TINNED			
		9	8	TAB 3.0 MM (22 MM)	CuSn4	PRE-TINNED			
		8	1	LOCKING-CLIP	PBT	BLACK			
		7	1	SLIDE (LEFT)	PBT	RED			
		6	1	SLIDE (RIGHT)	PBT	RED			
		3	1	32 POS. TAB HSG., COD. C1	PBT	BLUE			
		10	24	TAB 1.6 MM (22 MM)	CuSn4	PRE-TINNED			
		9	8	TAB 3.0 MM (22 MM)	CuSn4	PRE-TINNED			
3-963179-1	B	8	1	LOCKING-CLIP	PBT	BLACK			
		7	1	SLIDE (LEFT)	PBT	RED			
		6	1	SLIDE (RIGHT)	PBT	RED			
		3	1	32 POS. TAB HSG., COD. C1	PBT	BLUE			
		10	24	TAB 1.6 MM (22 MM)	CuSn4	PRE-TINNED			
		9	8	TAB 3.0 MM (22 MM)	CuSn4	PRE-TINNED			
		8	1	LOCKING-CLIP	PBT	BLACK			
		7	1	SLIDE (LEFT)	PBT	RED			
		6	1	SLIDE (RIGHT)	PBT	RED			
		2	1	32 POS. TAB HSG., COD. B1	PBT	GREY			
2-963179-1	B	10	24	TAB 1.6 MM (22 MM)	CuSn4	PRE-TINNED			
		9	8	TAB 3.0 MM (22 MM)	CuSn4	PRE-TINNED			
		8	1	LOCKING-CLIP	PBT	BLACK			
		7	1	SLIDE (LEFT)	PBT	RED			
		6	1	SLIDE (RIGHT)	PBT	RED			
		2	1	32 POS. TAB HSG., COD. B1	PBT	GREY			
		10	24	TAB 1.6 MM (22 MM)	CuSn4	PRE-TINNED			
		9	8	TAB 3.0 MM (22 MM)	CuSn4	PRE-TINNED			
		8	1	LOCKING-CLIP	PBT	BLACK			
		7	1	SLIDE (LEFT)	PBT	RED			
1-963179-1	B	6	1	SLIDE (RIGHT)	PBT	RED			
		1	1	32 POS. TAB HSG., COD. A1	PBT	BLACK			
		10	24	TAB 1.6 MM (22 MM)	CuSn4	PRE-TINNED			
		9	8	TAB 3.0 MM (22 MM)	CuSn4	PRE-TINNED			
		8	1	LOCKING-CLIP	PBT	BLACK			
		7	1	SLIDE (LEFT)	PBT	RED			
		6	1	SLIDE (RIGHT)	PBT	RED			
		1	1	32 POS. TAB HSG., COD. A1	PBT	BLACK			
		10	24	TAB 1.6 MM (22 MM)	CuSn4	PRE-TINNED			
		9	8	TAB 3.0 MM (22 MM)	CuSn4	PRE-TINNED			

ZEICHNUNG GÖLTIG AB
 AMP
 AMP DEUTSCHLAND GMBH
 D-83209 Lengen
 32 POS. TAB HSG., ENDASSY
 963179