

NUMBER 178288  
METRIC

PRINT DIST  
DIMENSIONS IN MM. DO NOT SCALE PRINT

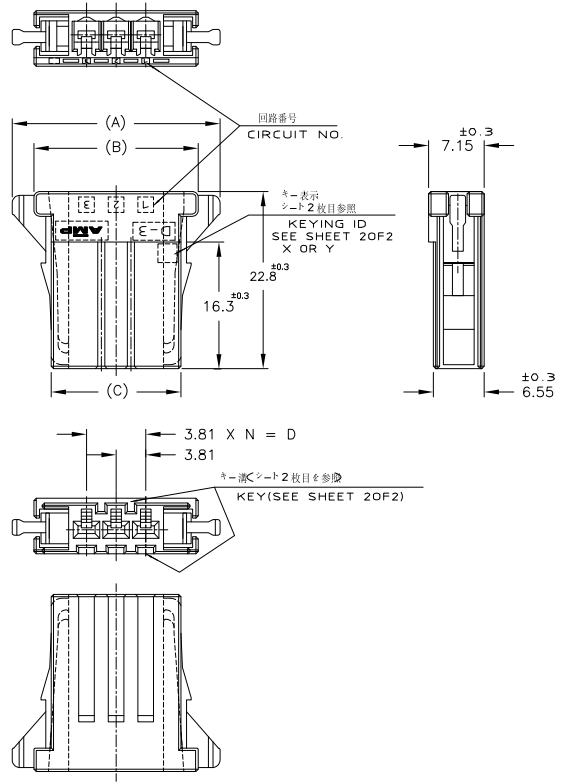

NOTE  
1 MATERIAL:GLASS FIELD THERMO PLASTIC,POLYESTER  
COLOR:BLACK  
~~△ TO COAT ALL SURFACE OF HOUSING WITH TEFLON~~

注記  
1 材料: ガラス入り熱可塑性ポリエステル樹脂  
色: 黒色  
~~△ ハロゲン系塗料でテフロン塗装すること~~

FINISH	POS	DIMENSION	A	B	C	D	N	PART NUMBER
	10 POS.		53.43	47.83	43.37	34.29	9	2-178288-8
	10 POS.		53.43	47.83	43.37	34.29	9	1-178288-8
	8 POS.		45.81	40.12	35.97	26.67	7	1-178288-7
	6 POS.		38.19	32.59	28.13	19.05	5	2-178288-6
	6 POS.		38.19	32.59	28.13	19.05	5	1-178288-6
	5 POS.		34.38	28.78	24.32	15.24	4	1-178288-5
	4 POS.		30.57	24.97	20.51	11.43	3	2-178288-4
	4 POS.		30.57	24.97	20.51	11.43	3	1-178288-4
OBSOLETE	<del>3 POS.</del>		<del>26.76</del>	<del>21.16</del>	<del>16.7</del>	<del>7.62</del>	<del>2</del>	<del>6-178288-3</del>
OBSOLETE	<del>3 POS.</del>		<del>26.76</del>	<del>21.16</del>	<del>16.7</del>	<del>7.62</del>	<del>2</del>	<del>5-178288-3</del>
	3 POS.		26.76	21.16	16.7	7.62	2	2-178288-3
	3 POS.		26.76	21.16	16.7	7.62	2	1-178288-3

				TE Connectivity	
				REC HSG FOR DYNAMIC, SINGLE ROW ダイナミックD-3100リセハウジング	
線径範囲(WIRE RANGE) mm(AWG -)		絶縁径(INSULATION DIA.) mmφ		品名(NAME) REC HSG FOR DYNAMIC, SINGLE ROW ダイナミックD-3100リセハウジング	
材料(MATERIAL) SEE NOTE 注記参照		仕上げ(FINISH)		一般公差 (GENERAL TOLERANCE) 10: ±0.25 20: ±0.15 30: ±0.10	
E4 REVISED PER ECO-11-005030 LTR 変更 (REVISION RECORD)		DR. N. Matsuda 17 JUL 91 CHK. T. Ogoe 17 JUL 91		DE. N. Matsuda 17 DEC '91 APP. S. MAMBE	
RK	HMR	SMART	DR.	DE.	APP.
CHK	DATE	DATE	DATE	DATE	DATE
SIZE A3		LOC J		REV. E4	
SCALE 2-1		REV. E4		SHEET 1 OF 2	

(CUSTOMER DRAWING) 顧客用図面

NUMBER 178288  
 METRIC  
 45° ANGLE PROJECTION

### KEYING LOCATION

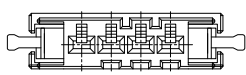

(P/N 2-178288-4 ONLY)  
(KEYING: Y)

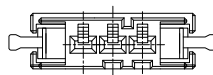

(P/N 2-178288-3 ONLY)  
(KEYING: Y)

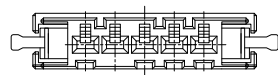

(P/N 2-178288-6,-8)  
(KEYING: Y)

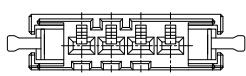

(P/N 1-178288-4 ONLY)  
(KEYING: X)

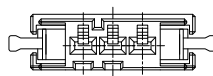

(P/N 1-178288-3 ONLY)  
(KEYING: X)

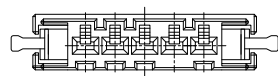

(P/N 1-178288-5,-6,-7,-8)  
(KEYING: X)

PRINT DIST  
 単位: H. DIMENSIONS IN MM. DO NOT SCALE PRINT

				<b>STE</b> TE Connectivity			
				品名 (NAME) <b>REC HSG FOR DYNAMIC, SINGLE ROW</b> ダイナミックD-3100リセハウジング			
線径範囲 (WIRE RANGE) 0.5~1.0mm (AWG -)		絶縁径 (INSULATION DIA.) 0.5mm		公差 (GENERAL TOLERANCE) 10: ±0.2 30: ±0.25 50: ±0.3		寸法 (SIZE) <b>A3 J</b>	
材料 (MATERIAL) SEE NOTE 注記参照				仕上げ (FINISH) —		数量 (QTY) <b>178288</b>	
設計 (DR.) SEE 1 OF 2		承認 (DE. OF APP.) 2		縮尺 (SCALE) 2-1		修訂 (REV.) <b>E4</b>	
LTR	変更 (REVISION RECORD)	DR	CHK	DATE	CHK.	SEE 1	SHEET 2 OF 2

(CUSTOMER DRAWING) 顧客用図面