

4

3

2

1

THIS DRAWING IS UNPUBLISHED. RELEASED FOR PUBLICATION  
 © COPYRIGHT BY TYCO ELECTRONICS CORPORATION. ALL RIGHTS RESERVED.

LOC	DIST	REVISIONS			
P	LTR	DESCRIPTION	DATE	DWN	APVD
0		REVISED	30NOV05	B.W	S.Y

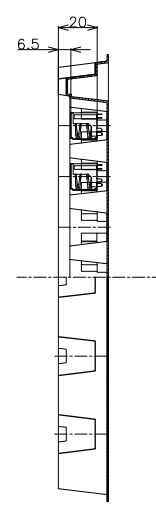
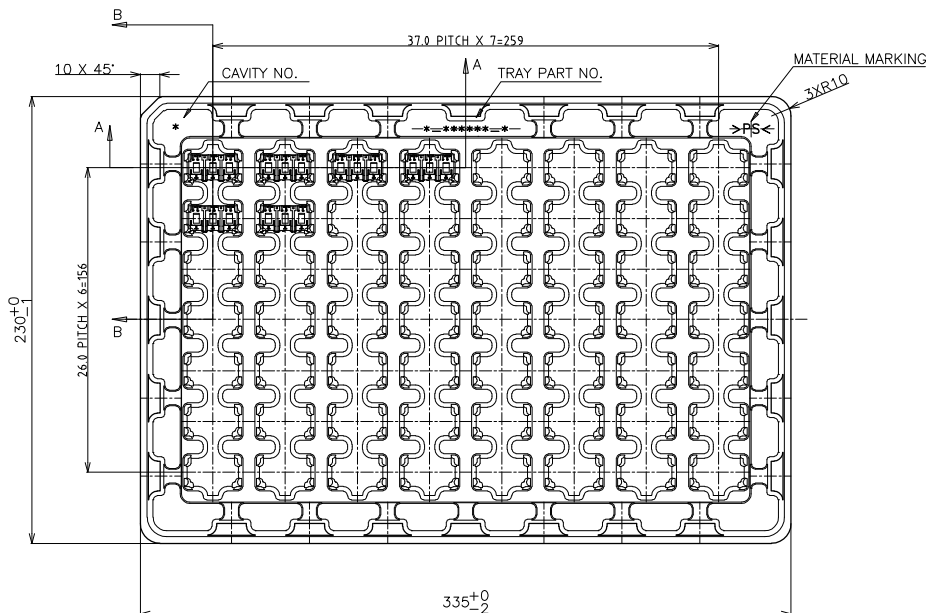

SECTION B-B

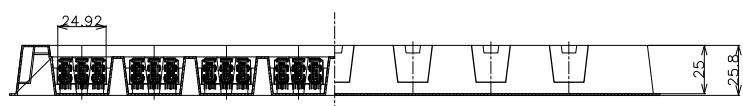

SECTION A-A

	1674456-3
FINISH	PART NO.

THIS DRAWING IS A CONTROLLED DOCUMENT.		DWN	30NOV05		Tyco Electronics Corporation	
		CHK	30NOV05		Shanghai, P.R.China, 200233	
DIMENSIONS:		C.ZHANG		NAME	HARD TRAY ASSY	
TOLERANCES UNLESS OTHERWISE SPECIFIED:		S.YAO			USB CONNECTOR	
MM	0 PLC ± 0.3	PRODUCT SPEC		REC 3P		
	1 PLC ± 0.3	APPLICATION SPEC		RESTRICTED TO		
	2 PLC ± 0.3	WEIGHT		SIZE	CAGE CODE	DRAWING NO
	3 PLC ± 0.3	CUSTOMER DRAWING		A3	00779	1674456
	4 PLC ± 0.3	SCALE		2:1		SHEET
	ANGLES ± 3'	SHEET		1		OF
MATERIAL	FINISH	REV		0		

AMP 1470-19 REV 31MAR2000

4

3

2

1

THIS DRAWING IS UNPUBLISHED. RELEASED FOR PUBLICATION  
 © COPYRIGHT BY TYCO ELECTRONICS CORPORATION. ALL RIGHTS RESERVED.

LOC	DIST	REVISIONS			
P	LTR	DESCRIPTION	DATE	DWN	APVD
SEE SHEET 1					

FRONT SHELL	③
CONTACT	②
HOUSING	①
NAME	ITEM No.

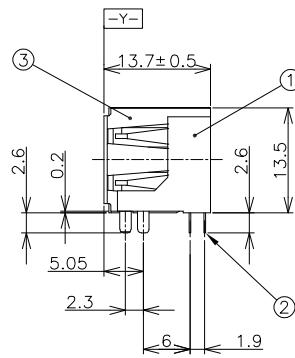
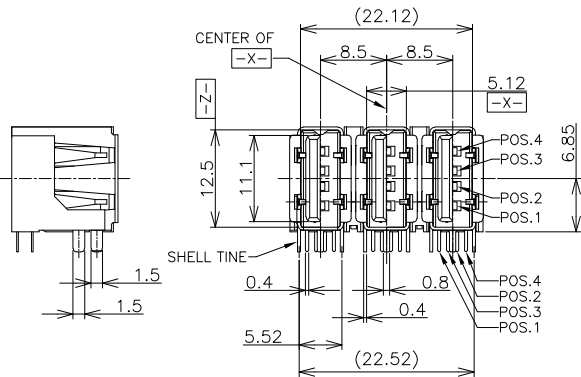
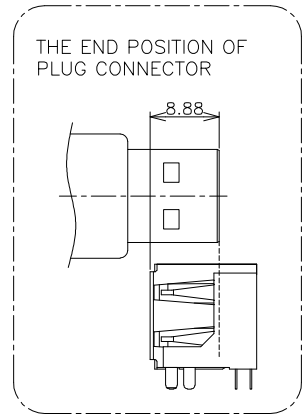
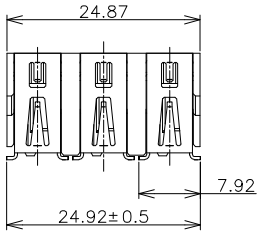

- △ MATERIAL  
HOUSING: THERMO-PLASTICS UL94V-0 BLACK  
CONTACT: COPPER ALLOY  
FRONT SHELL: COPPER ALLOY
- △ FINISH  
CONTACT: NICKEL UNDER PLATE ALL OVER.  
CONTACT AREA: GOLD PLATE  
TINE AREA: TIN PLATING  
FRONT SHELL: TIN PLATE

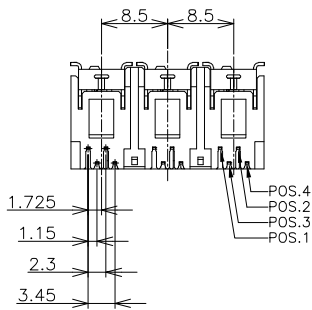
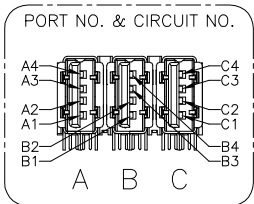

THIS DRAWING IS A CONTROLLED DOCUMENT.		DWN	Tyco Electronics Corporation Shanghai, P.R.China, 200233	
DIMENSIONS:	TOLERANCES UNLESS OTHERWISE SPECIFIED:	CHK	NAME	
MM	0 PLC ± 0.3 1 PLC ± 0.3 2 PLC ± 0.3 3 PLC ± 0.3 4 PLC ± 0.3 ANGLES ± 3'	APVD	HARD TRAY ASSY USB CONNECTOR REC 3P	
MATERIAL	FINISH	PRODUCT SPEC	SIZE	CAGE CODE
		APPLICATION SPEC	A3	00779
		WEIGHT	DRAWING NO.	RESTRICTED TO
		CUSTOMER DRAWING	C-1674456	
		SCALE	2:1	SHEET 2 OF 3
				REV 0

AMP 1470-19 REV 31MAR2000

4

3

2

1

THIS DRAWING IS UNPUBLISHED. RELEASED FOR PUBLICATION  
 © COPYRIGHT BY TYCO ELECTRONICS CORPORATION. ALL RIGHTS RESERVED.

LOC	DIST	REVISIONS			
P	LTR	DESCRIPTION	DATE	OWN	APVD
-	-	SEE SHEET 1	-	-	-

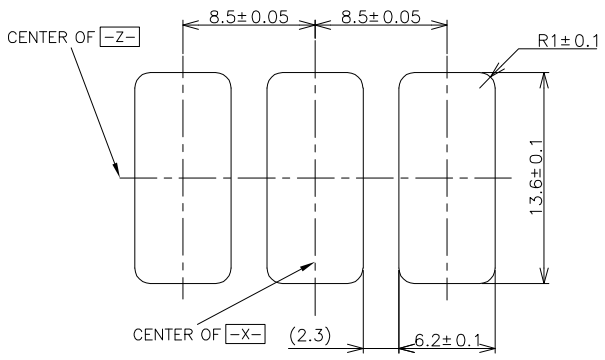
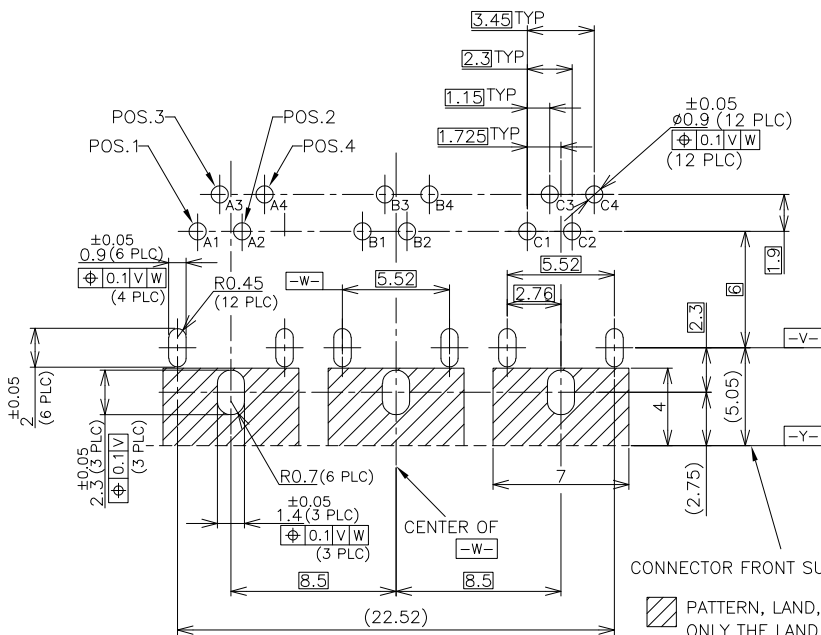

\* THIS DIMENSIONS ARE NOT CONSIDERATION  
 PANEL TOLERANCE AND PANEL ASSEMBLY TOLERANCE.

RECOMMENDED PANEL DIMENSION  
 (SCALE 4:1)

CONNECTOR FRONT SURFACE

PATTERN, LAND, VIA HOLE, MOUNT, PROHIBITION AREA.  
 ONLY THE LAND FOR SOLDERING OF FRONT SHELL IS OK.

RECOMMENDED LAYOUT OF P.C.B  
 (CONNECTOR MOUNTING SIDE)  
 RECOMMENDED THICKNESS:1.0~1.6mm

THIS DRAWING IS A CONTROLLED DOCUMENT.

DIMENSIONS:	TOLERANCES UNLESS OTHERWISE SPECIFIED:
MM	
	0 PLC ± 0.3
	1 PLC ± 0.3
	2 PLC ± 0.3
	3 PLC ± 0.3
	4 PLC ± 0.3
	ANGLES ± 3'

OWN	
CHK	
APVD	
PRODUCT SPEC	
APPLICATION SPEC	
WEIGHT	
CUSTOMER DRAWING	

		Tyco Electronics Corporation Shanghai, P.R.China, 200233	
NAME: HARD TRAY ASSY USB CONNECTOR REC 3P			
SIZE	CAGE CODE	DRAWING NO	RESTRICTED TO
A3	00779	C=1674456	
SCALE: 5:1		SHEET: 3 OF 3	REV: 0