

4

3

2

1

THIS DRAWING IS UNPUBLISHED.

RELEASED FOR PUBLICATION DEC. 2001.

© COPYRIGHT 2001 By -

ALL RIGHTS RESERVED.

LOC J DIST

REVISIONS

P	LTR	DESCRIPTION	DATE	DWN	APVD
E2		REVISED PER ECO-11-005030	11MAR11	RK	HMR

4-1565589-3  
1565589-2  
; AS SHOWN

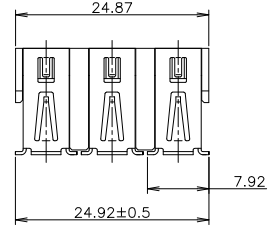

△ MATERIAL  
HOUSING: THERMO-PLASTICS UL94V-0 BLACK  
CONTACT: COPPER ALLOY  
FRONT SHELL: COPPER ALLOY  
△ FINISH  
CONTACT: NICKEL UNDER PLATE ALL OVER.  
CONTACT AREA: GOLD PLATE  
TINE AREA: TIN-LEAD PLATING  
FRONT SHELL: TIN-LEAD PLATE OR TIN PLATE  
△ FINISH  
CONTACT: NICKEL UNDER PLATE ALL OVER.  
CONTACT AREA: GOLD PLATE  
TINE AREA: TIN PLATING  
FRONT SHELL: TIN PLATE

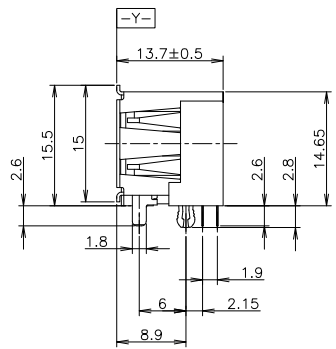
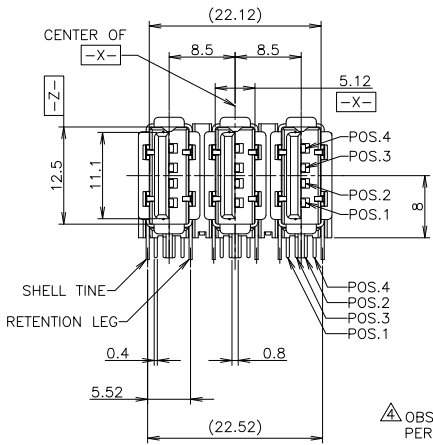
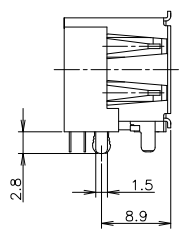
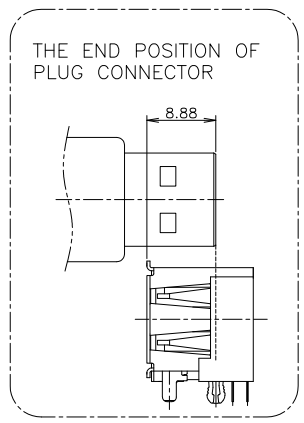

△ OBSOLETE PARTS: OBSOLETE CIS STREAMLINING PER D.RENAUD/D.SINISI

△ OBSOLETE

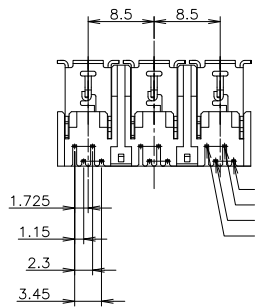
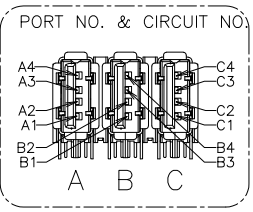

SEE SHEET 5, 6	△	6-1565589-2
SEE SHEET 3, 4	△	3-1565589-3
SEE SHEET 1, 2	△	6-1565589-1
	△	4-1565589-3
	△	1565589-2
REMARK	FINISH	PART NO.

THIS DRAWING IS A CONTROLLED DOCUMENT.

DIMENSIONS: 単位: ㎜	TOLERANCES UNLESS OTHERWISE SPECIFIED: 単位: ㎜	DWN S.TODA 12DEC2001	TE Connectivity	
0 PLC ±0.3	1 PLC ±0.3	CHK J.TANIGAWA 12DEC2001	NAME 名	
2 PLC ±0.3	3 PLC ±0.3	APVD H.KODAMA 12DEC2001	PRODUCT SPEC 製品規格	
4 PLC ±0.3	ANGLES ±3°	FINISH 仕上	APPLICATION SPEC 取付適用規格	
MATERIAL 材料	SEE TABLE	WEIGHT	SIZE A3	CAGE CODE 00779
		CUSTOMER DRAWING	DRAWING NO 番号 1565589	RESTRICTED TO
			SCALE 尺度 2:1	SHEET 1 of 6
				REV E2

THIS DRAWING IS UNPUBLISHED. RELEASED FOR PUBLICATION DEC. 2001.  
 ALL RIGHTS RESERVED.

LOC		DIST		REVISIONS			
P	LTR	DESCRIPTION		DATE	DWN	APVD	
-	-	SEE SHEET 1		-	-	-	-

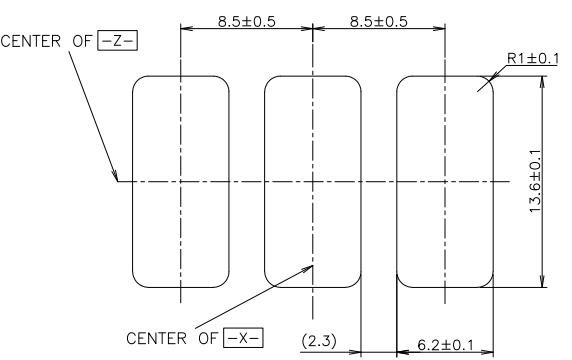
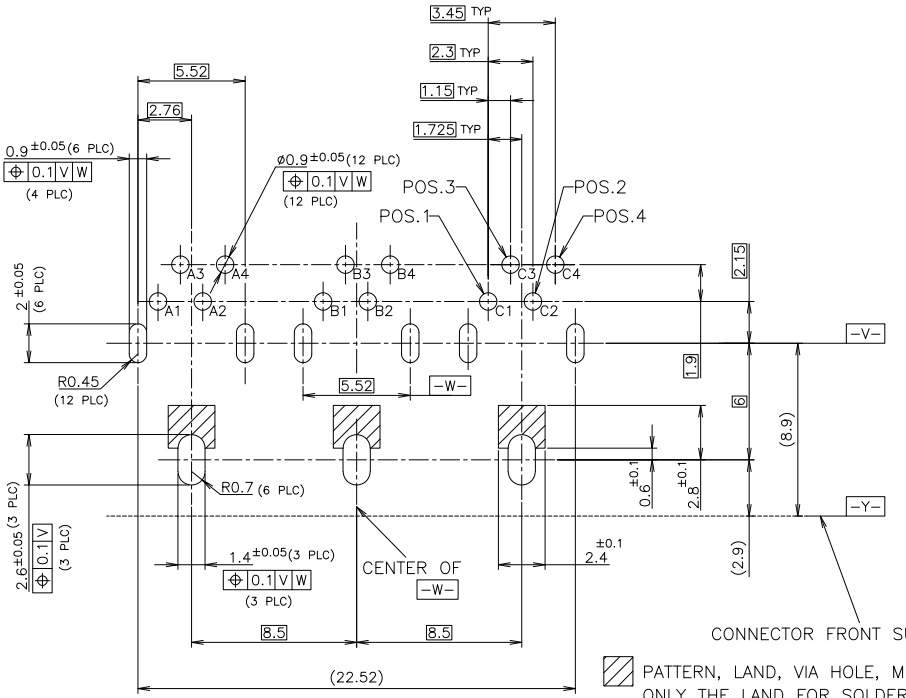

\*THIS DIMENSIONS ARE NOT CONSIDERATION  
 PANEL TOLERANCE AND PANEL ASSEMBLY TOLERANCE.  
 RECOMMENDED PANEL DIMENSION

CONNECTOR FRONT SURFACE  
 PATTERN, LAND, VIA HOLE, MOUNT, PROHIBITION AREA.  
 ONLY THE LAND FOR SOLDERING OF FRONT SHELL IS OK.

RECOMMENDED LAYOUT OF P.C.B  
 (CONNECTOR MOUNTING SIDE)  
 RECOMMENDED THICKNESS: 1.0~1.6mm

APPLICATION PRODUCT: 1565589-2  
 4-1565589-3

THIS DRAWING IS A CONTROLLED DOCUMENT.		DWN		TE Connectivity NAME 名称 USB CONNECTOR RECEPTACLE TYPE	
DIMENSIONS: 單位: 毫米		TOLERANCES UNLESS OTHERWISE SPECIFIED: 公差			
		0 PLC ±0.3 1 PLC ±0.3 2 PLC ±0.3 3 PLC ±0.3 4 PLC ±0.3 ANGLES ±3°		DRAWING NO 番号	
MATERIAL 材料		FINISH 仕上		1565589	
				RESTRICTED TO	
		CUSTOMER DRAWING		SCALE 尺度	5:1
				SHEET	2 of 6
				REV	E2

4

3

2

1

THIS DRAWING IS UNPUBLISHED. RELEASED FOR PUBLICATION DEC. 2001.  
 ALL RIGHTS RESERVED.

LOC		DIST		REVISIONS			
				變更			
P	LTR	DESCRIPTION		DATE	DWN	APVD	
-	-	SEE SHEET 1		-	-	-	

6-1565589-1  
 ; AS SHOWN

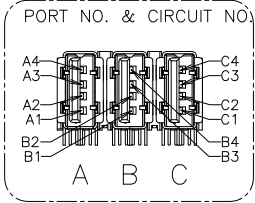
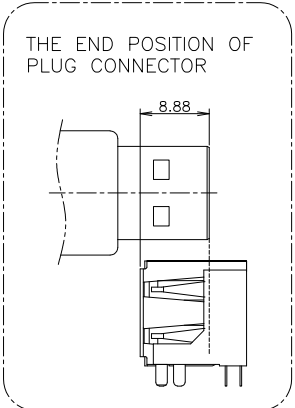
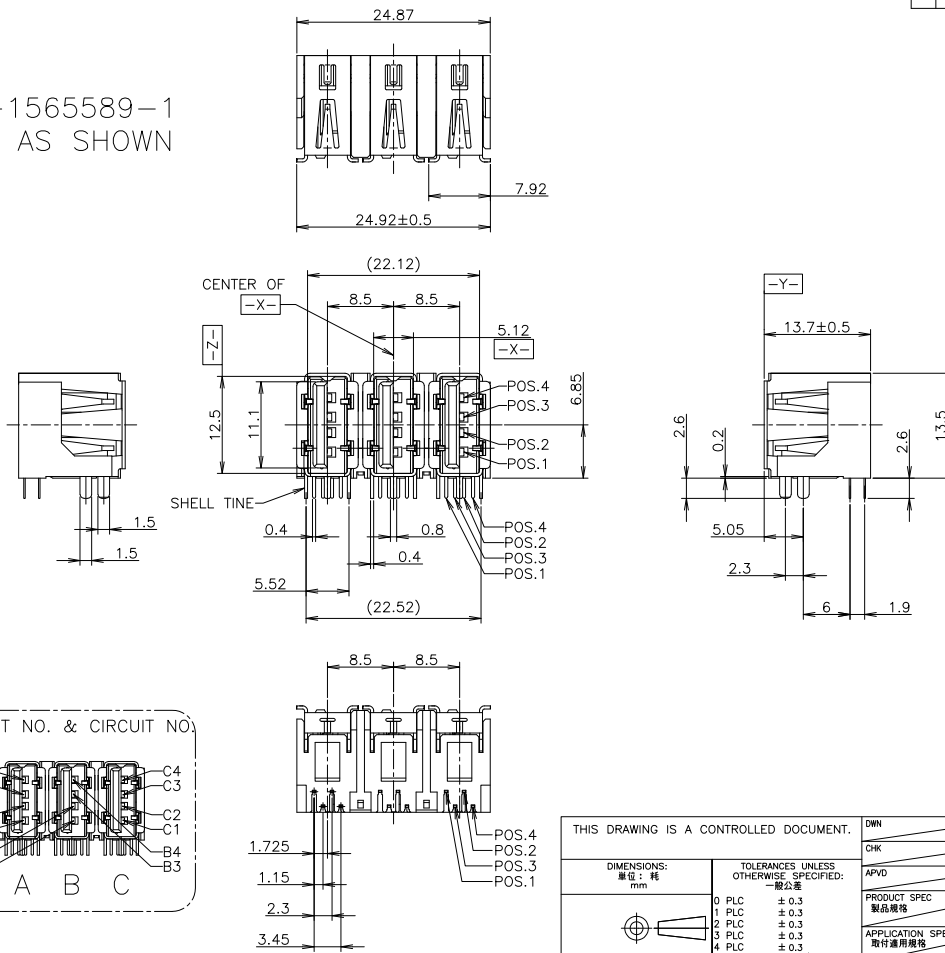

THIS DRAWING IS A CONTROLLED DOCUMENT.		DWN			
DIMENSIONS: 單位: 毫米		CHK			
TOLERANCES UNLESS OTHERWISE SPECIFIED: 除公差		APVD	NAME 名稱		
0 PLC ± 0.3		PRODUCT SPEC 製品規格		USB CONNECTOR RECEPTACLE TYPE	
1 PLC ± 0.3		APPLICATION SPEC 取付適用規格		SIZE A3	CAGE CODE 00779
2 PLC ± 0.3		WEIGHT		DRAWING NO. 圖號	RESTRICTED TO
3 PLC ± 0.3		CUSTOMER DRAWING		1565589	
4 PLC ± 0.3		SCALE 尺度		5:1	SHEET 3 of 6
ANGLES ± 0.3		FINISH 仕上		REV E2	

4

3

2

1

THIS DRAWING IS UNPUBLISHED. RELEASED FOR PUBLICATION DEC. 2001.  
 © COPYRIGHT 2001 By - ALL RIGHTS RESERVED.

LOC		DIST		REVISIONS				
				変更		DATE	DWN	APVD
P	LTR	DESCRIPTION						
-	-	SEE SHEET 1		-	-	-	-	-

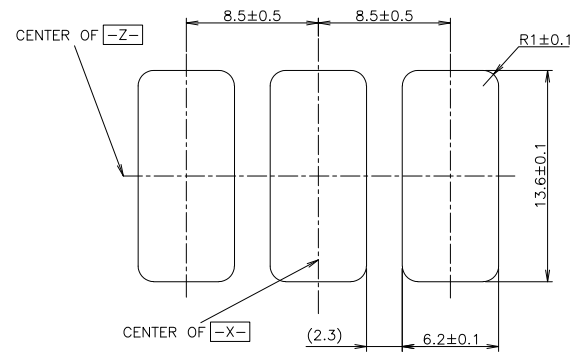
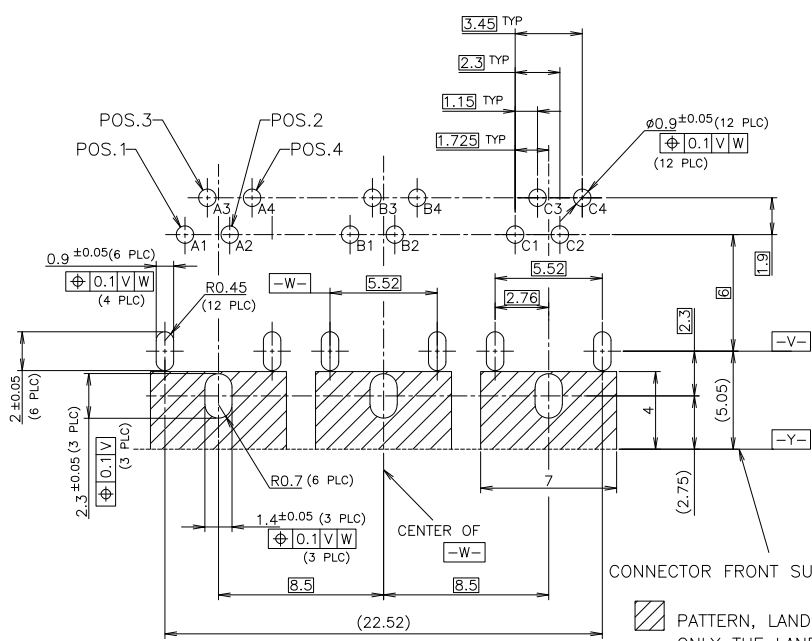

\*THIS DIMENSIONS ARE NOT CONSIDERATION  
 PANEL TOLERANCE AND PANEL ASSEMBLY TOLERANCE.  
 RECOMMENDED PANEL DIMENSION

CONNECTOR FRONT SURFACE  
 PATTERN, LAND, VIA HOLE, MOUNT, PROHIBITION AREA.  
 ONLY THE LAND FOR SOLDERING OF FRONT SHELL IS OK.

RECOMMENDED LAYOUT OF P.C.B  
 (CONNECTOR MOUNTING SIDE)  
 RECOMMENDED THICKNESS: 1.0~1.6mm

THIS DRAWING IS A CONTROLLED DOCUMENT.		DWN		TE Connectivity NAME 名称 USB CONNECTOR RECEPTACLE TYPE	
DIMENSIONS: 單位: 毫米		CHK			
TOLERANCES UNLESS OTHERWISE SPECIFIED: 公差		APVD		PRODUCT SPEC 製品規格	
0 PLC ± 0.3		APVD		APPLICATION SPEC 取付適用規格	
1 PLC ± 0.3		WEIGHT		SIZE A3	
2 PLC ± 0.3		CAGE CODE		CAGE CODE 00779	
3 PLC ± 0.3		DRAWING NO 番号		DRAWING NO 1565589	
4 PLC ± 0.3		RESTRICTED TO		SCALE 尺度 5:1	
ANGLES ± 0.3		CUSTOMER DRAWING		SHEET 4 of 6	
FINISH 仕上		REV E2			

4

3

2

1

THIS DRAWING IS UNPUBLISHED. RELEASED FOR PUBLICATION DEC. 2001.  
 © COPYRIGHT 2001 By - ALL RIGHTS RESERVED.

LOC		DIST		REVISIONS			
J				變更			
P	LTR	DESCRIPTION		DATE	DWN	APVD	
-	-	SEE SHEET 1		-	-	-	

6-1565589-2  
 3-1565589-3  
 ; AS SHOWN

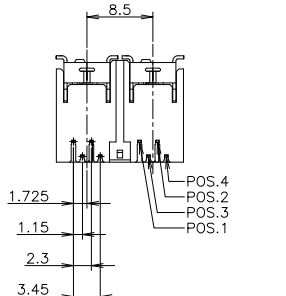
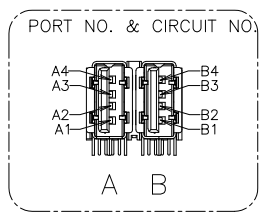
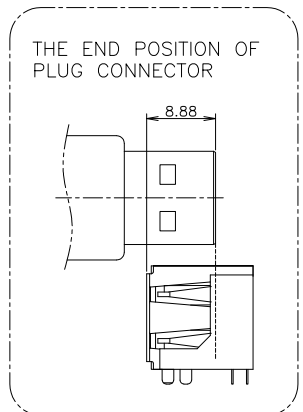
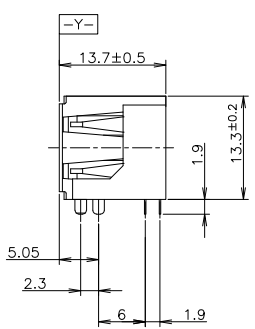
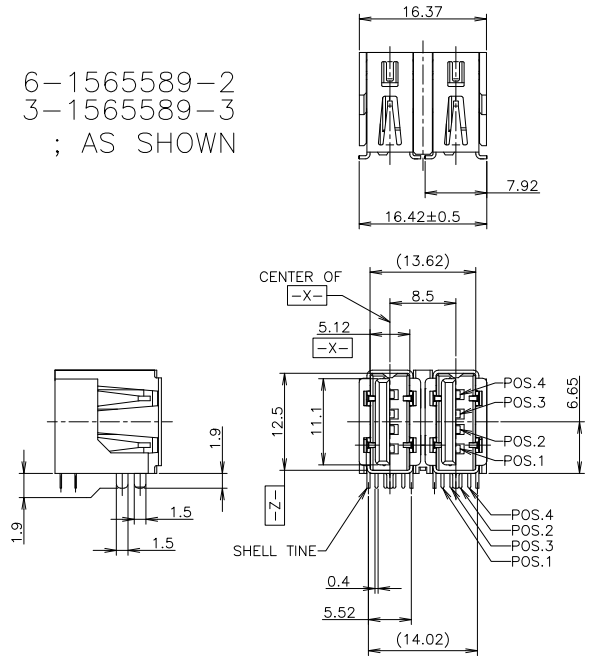

THIS DRAWING IS A CONTROLLED DOCUMENT.		DWN				
DIMENSIONS: 單位: 毫米 mm		CHK				
TOLERANCES UNLESS OTHERWISE SPECIFIED: 一般公差		APVD	NAME 名稱			
		PRODUCT SPEC 製品規格		USB CONNECTOR RECEPTACLE TYPE		
		APPLICATION SPEC 取付適用規格		SIZE	CAGE CODE	DRAWING NO 圖號
		MATERIAL 材料		A3	00779	C=1565589
		FINISH 仕上		RESTRICTED TO		
		WEIGHT		CUSTOMER DRAWING		
		SCALE 尺碼 5:1		SHEET 5 of 6 REV E2		

4

3

2

1

THIS DRAWING IS UNPUBLISHED. RELEASED FOR PUBLICATION DEC. 2001.  
 © COPYRIGHT 2001 By - ALL RIGHTS RESERVED.

LOC		DIST		REVISIONS				
				変更		DATE	DWN	APVD
P	LTR	DESCRIPTION						
-	-	SEE SHEET 1		-	-	-	-	-

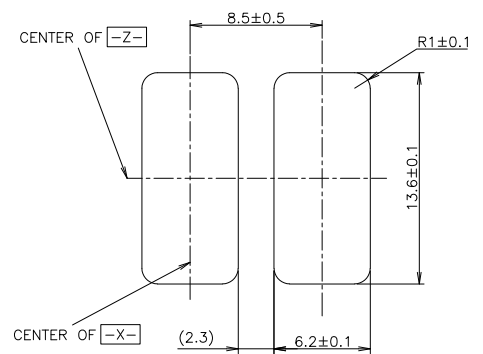
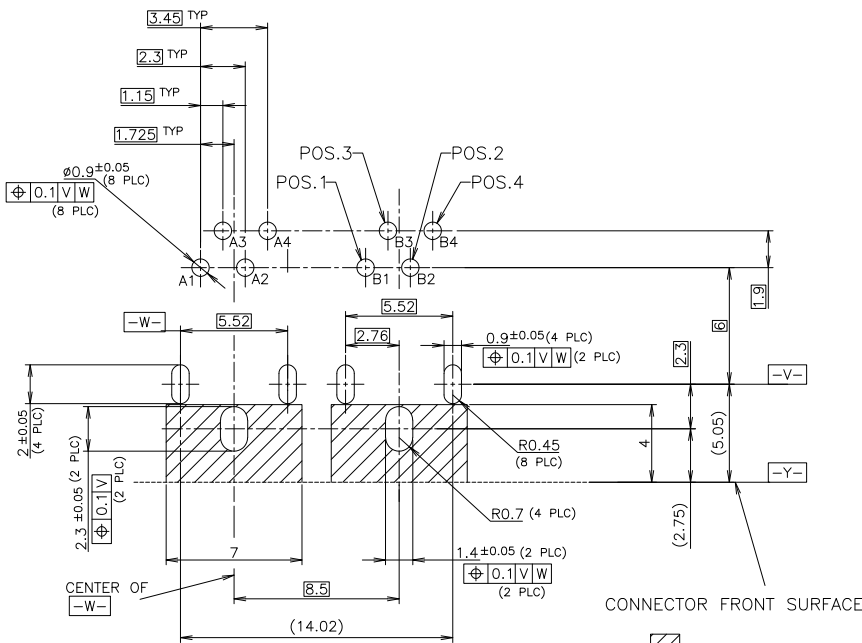

\*THIS DIMENSIONS ARE NOT CONSIDERATION  
 PANEL TOLERANCE AND PANEL ASSEMBLY TOLERANCE.  
 RECOMMENDED PANEL DIMENSION

CONNECTOR FRONT SURFACE

PATTERN, LAND, VIA HOLE, MOUNT, PROHIBITION AREA.  
 ONLY THE LAND FOR SOLDERING OF FRONT SHELL IS OK.

RECOMMENDED LAYOUT OF P.C.B  
 (CONNECTOR MOUNTING SIDE)  
 RECOMMENDED THICKNESS: 1.0~1.2mm

THIS DRAWING IS A CONTROLLED DOCUMENT.		DWN	TE Connectivity	
DIMENSIONS: 單位: 毫米		CHK		
TOLERANCES UNLESS OTHERWISE SPECIFIED: 一般公差		APVD	NAME 名稱	
0 PLC ± 0.3		PRODUCT SPEC 製品規格		
1 PLC ± 0.3		APPLICATION SPEC 取付適用規格		
2 PLC ± 0.3		SIZE	CAGE CODE	DRAWING NO 圖號
3 PLC ± 0.3		A3	00779	C=1565589
4 PLC ± 0.3		RESTRICTED TO		
ANGLES ± 0.3		WEIGHT		
MATERIAL 材料	FINISH 仕上	CUSTOMER DRAWING		
		SCALE 尺度	5:1	SHEET 張
		6 of 6		REV E2