

LOC	DIST	REVISIONS			
F	LTR	DESCRIPTION	DATE	OWN	APVD
DY	-				
A		NPR ECR-07-017845	03SEP2007	YKW	LSF

NOTE:

⚠ MATERIAL:
HOUSING: HIGH TEMP THERMOPLASTIC, UL94 V-0, BLACK
CONTACT: COPPER ALLOY

⚠ FINISH:
CONTACT: "A" MIN GOLD AT MATING AREA (SEE TABLE)
AND 0.05µm MIN GOLD AT SOLDER TAIL AREA
WITH 1.27µm MIN NICKEL UNDERPLATE ALL OVER.

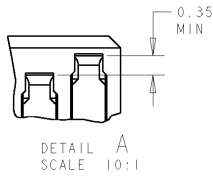
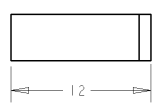

0.76µm	1735443-3
0.38µm	1735443-2
0.05µm	1735443-1
"A"	PART NO.

DIMENSIONS:		TOLERANCES UNLESS OTHERWISE SPECIFIED:		OWN	DATE	Tyco Electronics	
mm		0 PLC	±0.20	KW YAP	03SEP2007	Tyco Electronics Singapore Pte. Ltd.	
		1 PLC	±0.20	CHK			
		2 PLC	±0.20	APVD			
		3 PLC	±0.20	NAME			
		4 PLC	±0.20	PRODUCT SPEC			
		ANGLES	±°	APPLICATION SPEC			
		FINISH	±°	WEIGHT		SIZE	CAGE CODE
MATERIAL						A3	00779
				CUSTOMER DRAWING		DRAWING NO	
						C-1735443	
						SCALE	SHEET
						1:1	1 OF 2
							REV
							A

AMP 1470-19 REV 09MAT194
PROJECT ENGINEER DRAWING

THIS DRAWING IS UNPUBLISHED. RELEASED FOR PUBLICATION
 COPYRIGHT 19 BY AMP INCORPORATED. ALL RIGHTS RESERVED.

LOC	DIST	REVISIONS					
DY	-	F	LTR	DESCRIPTION	DATE	OWN	APVD
				SEE SHEET 1			

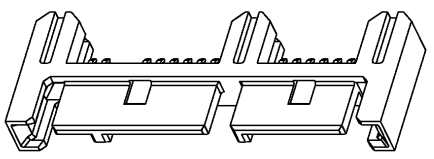
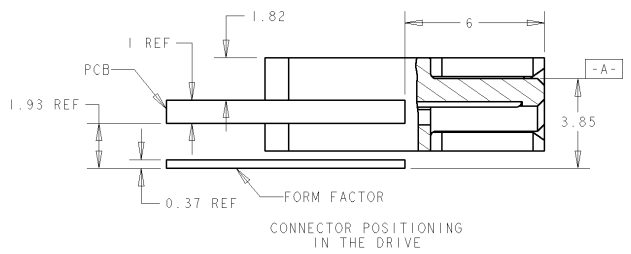
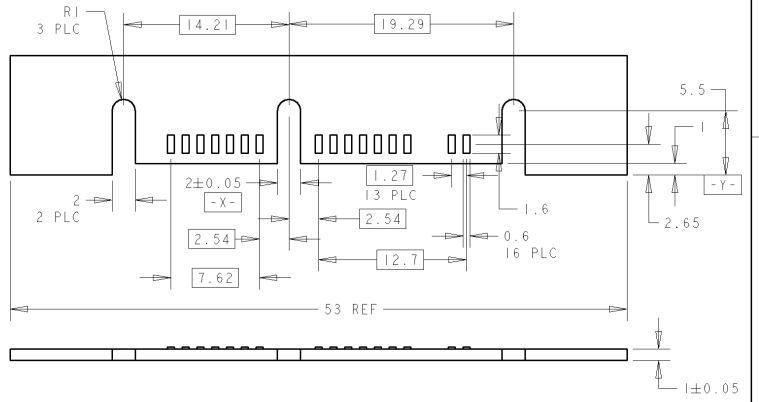
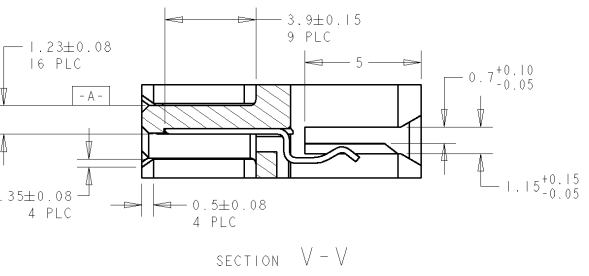
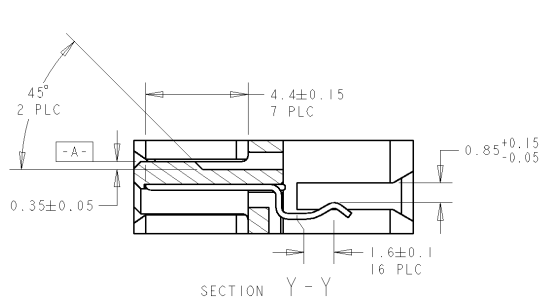

<small>THIS DRAWING IS A CONTROLLED DOCUMENT FOR AMP INCORPORATED IT IS SUBJECT TO CHANGE AND THE CONTROLLING ENGINEERING ORGANIZATION SHOULD BE CONTACTED FOR THE LATEST REVISION.</small>		DWN 23MAY2007 CHK KW YAP SF LEONG APVD SF LEONG	Tyco Electronics Tyco Electronics Singapore Pte. Ltd.
DIMENSIONS: mm	TOLERANCES UNLESS OTHERWISE SPECIFIED: 0 PLC ±0.20 1 PLC ±0.20 2 PLC ±0.20 3 PLC ±0.20 4 PLC ± ANGLES ±°	NAME PRODUCT SPEC 108-51089 APPLICATION SPEC	CONNECTOR, MICRO SATA PLUG, 7P+9P STRADDLE MOUNT
MATERIAL	FINISH	WEIGHT -	SIZE A3 CAGE CODE 00779 DRAWING NO. C-1735443
CUSTOMER DRAWING		SCALE 1:1	SHEET 2 OF 2 REV A

AMP 1470-19 REV 09MAY94