

REV	DESCRIPTION	DATE	BY	CHK
A	RELEASED PER ECO-10-000080	11/09/10	CR	MS
A1	ADDED ALTY. PANEL CUT-OUT	11/09/10	CR	MS
B	REVISED PER ECO-10-013148	12/01/10	CLJ	JAP

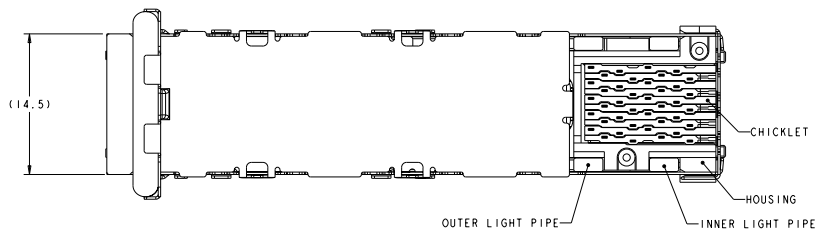
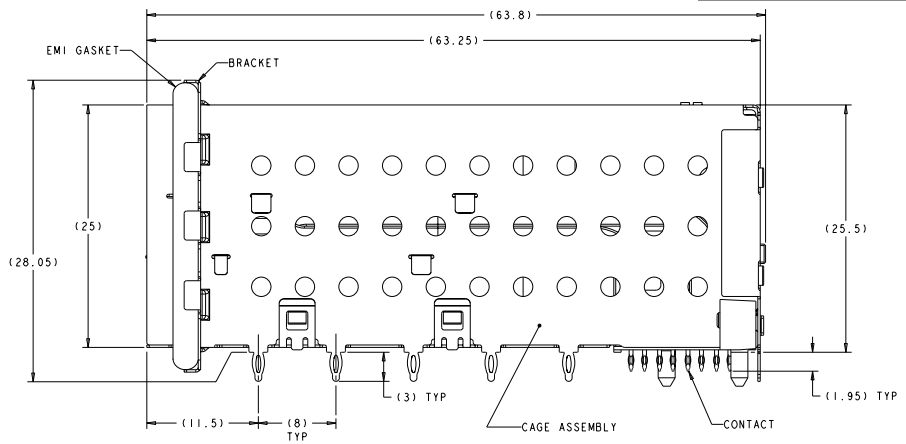
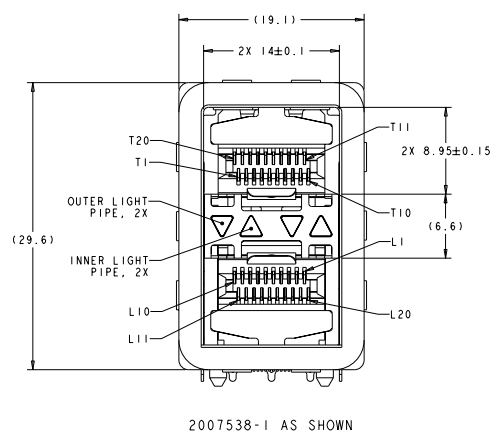

- △ MATERIALS:
 CAGE ASSEMBLY- NICKEL SILVER ALLOY PER ASTM B 122.
 BRACKET- STAINLESS STEEL.
 EMI GASKET- PLATED FILLED SILICONE.
 HOUSING- BLACK LCP, UL 94V-0 RATED.
 CHICKLET- BLACK LCP, UL 94V-0 RATED.
 LIGHT PIPE- POLYCARBONATE, CLEAR, UL 94V-2 RATED.
 INSERT - (FOR LIGHT PIPE PART NUMBERS ONLY) - PBT, BLACK, UL 94V-0.
 CONTACT- COPPER ALLOY.
- △ DATUM AND BASIC DIMENSIONS ESTABLISHED BY CUSTOMER.
- 3. MINIMUM PCB THICKNESS OF 1.5.
- △ CONTACT FINISH- CONFORMS TO THE REQUIREMENTS OF TYCO ELECTRONICS PRODUCT SPECIFICATION 108-2331, BASED ON EIA/ECA-364-1000, 01A, (CONTROLLED ENVIRONMENT APPLICATIONS) ON MATING INTERFACE, TIN-LEAD ON NEEDLE EYE.
- △ CONTACT FINISH- CONFORMS TO THE REQUIREMENTS OF TYCO ELECTRONICS PRODUCT SPECIFICATION 108-2331, BASED ON EIA/ECA-364-1000, 01A, (CONTROLLED ENVIRONMENT APPLICATIONS) ON MATING INTERFACE, TIN ON NEEDLE EYE.
- △ FOR HOLE SIZE AND PLATINGS, SEE APPLICATION SPEC 114-13219.
- △ THE ENTIRE AREA OF THE CONNECTOR FOOTPRINT, INDICATED BY THE DASHED LINE, TO BE CONSIDERED THE KEEPOUT AREA FOR COMPONENTS AND SIGNAL TRACES, TOP SIDE ONLY. TOP SIDE TRACES ALLOWED WITHIN CONNECTOR HOLE PATTERN.
- △ LIGHT PIPE PAD LAYOUT IS FOR 0805 LOW PROFILE LED PACKAGE WITH A HEIGHT OF 0.8mm.

FINISH	DESCRIPTION	PART NUMBER
△	NO LIGHT PIPES	2007538-8
△	OUTER 2 LIGHT PIPES	2007538-7
△	INNER 2 LIGHT PIPES	2007538-6
△	4 LIGHT PIPES	2007538-5
△	NO LIGHT PIPES	2007538-4
△	OUTER 2 LIGHT PIPES	2007538-3
△	INNER 2 LIGHT PIPES	2007538-2
△	4 LIGHT PIPES	2007538-1

REV: 00 DATE: 03/24/2007 BY: JAP CHECKED: CR APPROVED: MS	TITLE: CAGE AND PT CONNECTOR ASSEMBLY. WITH EMI GASKET. PRESS FIT, 2X1, STACKED SFP.	PART NUMBER: 2007538 REV: A DATE: 03/24/2007	Tyco Electronics Harrisburg, PA 17105-3600
---	--	--	---

DATE SHOWN IN DIMENSIONS RECEIVED FOR FABRICATION
 00000000 BY TECH ELECTRONICS COMPANY, ALL RIGHTS RESERVED

REVISOR		REVISIONS	
DATE	BY	DESCRIPTION	DATE
GP	00	SEE SHEET 1	

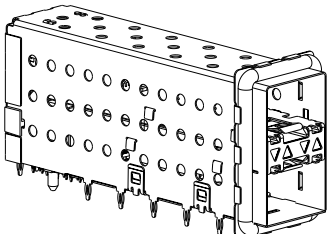

2007538-1 AND 2007538-5
 SCALE 3:1

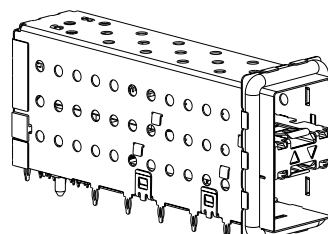

2007538-2 AND 2007538-6
 SCALE 3:1

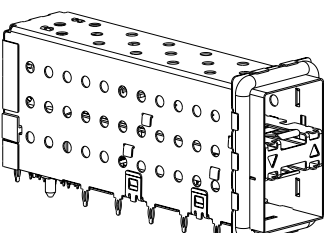

2007538-3 AND 2007538-7
 SCALE 3:1

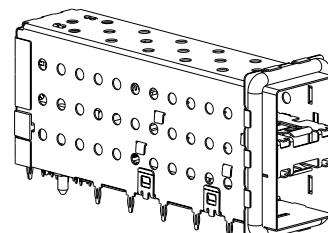

2007538-4 AND 2007538-8
 SCALE 3:1

DATE: 03JAN2007 BY: SUCCELY CHECKED: SUCCELY 100-2281 114-13219 CUSTOMER DRAWING		DATE: 03JAN2007 BY: SUCCELY CHECKED: SUCCELY 100-2281 114-13219 CUSTOMER DRAWING		Tech Electronics Harrisburg, PA 17105-3600 CAGE AND PT CONNECTOR ASSEMBLY. WITH EMI GASKET PRESS FIT, 2X1, STACKED SFP+ STATE CASE CODE (DRAWING NO) A 00779 2007538 SHEET 2 OF 4	
---	--	---	--	---	--

REVISOR		REVISIONS	
NO.	DATE	DESCRIPTION	BY
00		SEE SHEET 1	

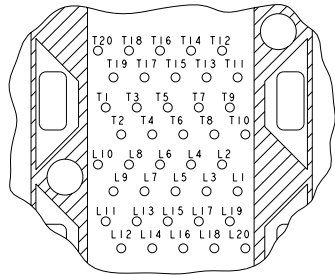
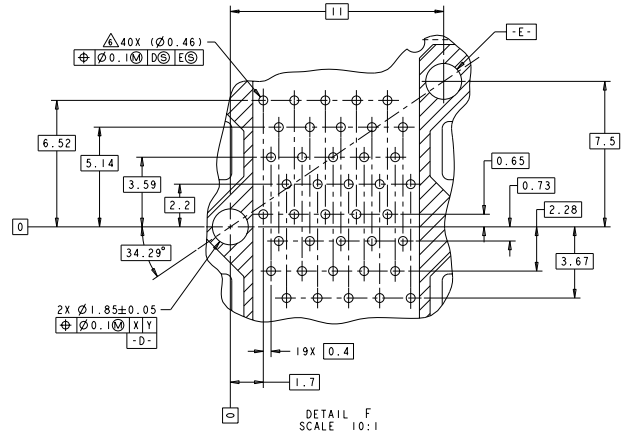
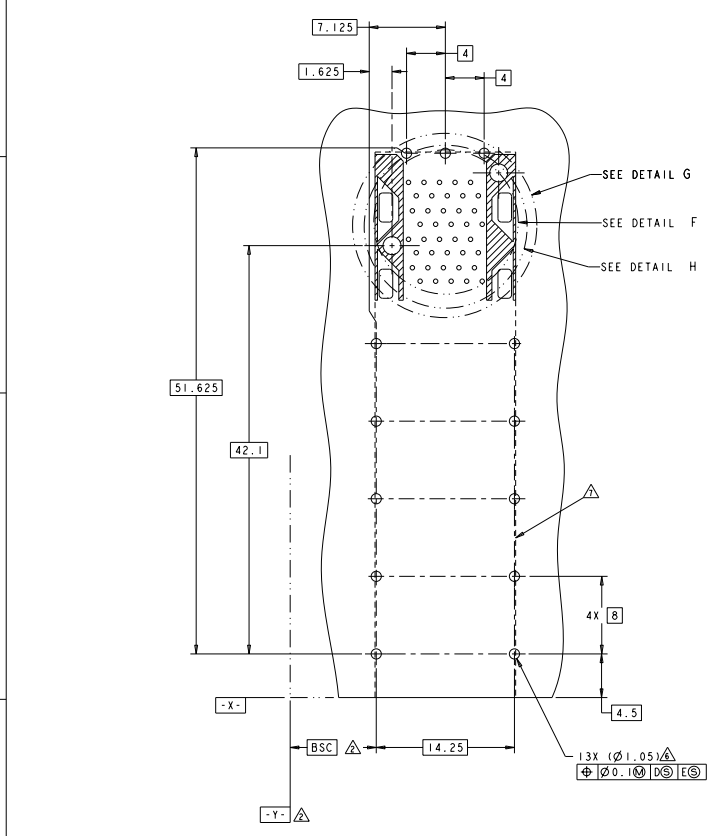

DATE: 03 JAN 2007	BY: [Signature]	DATE: 03 JAN 2007	BY: [Signature]
REV: 00	REV: 00	REV: 00	REV: 00
APP: [Signature]	APP: [Signature]	APP: [Signature]	APP: [Signature]
CHK: [Signature]	CHK: [Signature]	CHK: [Signature]	CHK: [Signature]
DRN: [Signature]	DRN: [Signature]	DRN: [Signature]	DRN: [Signature]
DES: [Signature]	DES: [Signature]	DES: [Signature]	DES: [Signature]
ENG: [Signature]	ENG: [Signature]	ENG: [Signature]	ENG: [Signature]
MAN: [Signature]	MAN: [Signature]	MAN: [Signature]	MAN: [Signature]
PRO: [Signature]	PRO: [Signature]	PRO: [Signature]	PRO: [Signature]
QA: [Signature]	QA: [Signature]	QA: [Signature]	QA: [Signature]
SRV: [Signature]	SRV: [Signature]	SRV: [Signature]	SRV: [Signature]
TRN: [Signature]	TRN: [Signature]	TRN: [Signature]	TRN: [Signature]
WHS: [Signature]	WHS: [Signature]	WHS: [Signature]	WHS: [Signature]
WRK: [Signature]	WRK: [Signature]	WRK: [Signature]	WRK: [Signature]
YTD: [Signature]	YTD: [Signature]	YTD: [Signature]	YTD: [Signature]
ZEN: [Signature]	ZEN: [Signature]	ZEN: [Signature]	ZEN: [Signature]

TE Tyco Electronics
 Harrisburg, PA 17105-3600
 CAGE AND PT CONNECTOR ASSEMBLY,
 WITH EMI GASKET,
 PRESS FIT, 2X1, STACKED SFP.
 STATE CASE CODE (SEE PAGE 40)
 A | 00779 | ©=2007538
 CUSTOMER DRAWING
 SHEET 5:1 OF 3

REVISED		REVISIONS			
NO.	DATE	DESCRIPTION	BY	CHK	APP
00		SEE SHEET 1			

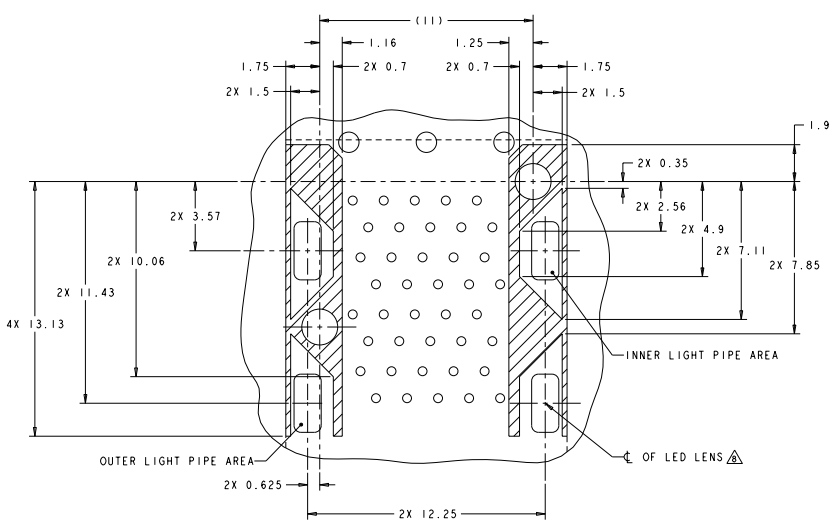

DETAIL G
 CONNECTOR HOUSING
 KEEPOUT ZONE
 SCALE 10:1

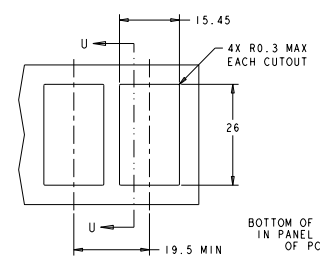

RECOMMENDED PANEL CUTOUT
 AND PC BOARD, PANEL POSITION
 SCALE 2:1

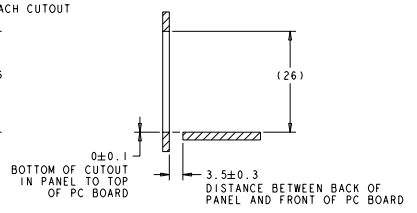

SECTION U-U

DATE: 03JAN2007 DRAWN BY: [Signature] CHECKED BY: [Signature]		DATE: 03JAN2007 DRAWN BY: [Signature] CHECKED BY: [Signature]		DATE: 03JAN2007 DRAWN BY: [Signature] CHECKED BY: [Signature]	
TITLE: CAGE AND PT CONNECTOR ASSEMBLY. WITH EMI GASKET. PRESS FIT, 2X1, STACKED SFP.		PART NO: 100-2281 SPECIFICATION NO: 114-13219		CUSTOMER DRAWING: A 00779 ©=2007538	